



WaNuLCAS 3.01

Background on a model of
Water, Nutrient and Light Capture in Agroforestry Systems

WaNuLCAS 3.01

Background on a model of
Water, Nutrient and Light Capture
in **Agroforestry Systems**



Meine van Noordwijk
Betha Lusiana
Ni'matul Khasanah



World Agroforestry Centre
TRANSFORMING LIVES AND LANDSCAPES

INTERNATIONAL CENTRE FOR RESEARCH IN AGROFORESTRY (ICRAF)

Correct citation:

Meine van Noordwijk, Betha Lusiana and Ni'matul Khasanah, 2004. WaNuLCAS version 3.1, Background on a model of water nutrient and light capture in agroforestry systems. International Centre for Research in Agroforestry (ICRAF), Bogor, Indonesia

PO Box 161, Bogor 16001, Indonesia

ISBN 979-95537-1-7

Copies of the software available freely from the web:

<http://www.worldagroforestrycentre/sea>

More information can be obtained by correspondence to:

M.van-Noordwijk@cgiar.org and/or B.Lusiana@cgiar.org

Related journal publication (based on version 1.0)

Van Noordwijk, M. and Lusiana, B., 1999 WaNuLCAS, a model of water, nutrient and light capture in agroforestry systems. *Agroforestry Systems* 43: 217-242

Disclaimer and copyright

This is a third release of a general model of tree-soil-crop interactions in agroforestry. Although efforts have been made to incorporate relevant process knowledge on a range of interactions, the model is not more (and not less) than a research tool. Model predictions may help in developing specific hypotheses for research, in exploring potential management options and extrapolation domains, but they should not be used as authoritative statements per se.

© Copy right, but do not copy wrong. The WaNuLCAS model was developed on the basis of publicly funded research at the International Centre for Research on Agroforestry (ICRAF) and may be used for non-commercial research purposes in the interest of the smallholder agroforesters of the world. The Stella modeling shell used is protected by international copyright.

Lay-out by:

Dwiati N Rini & Hulaesuddin, ICRAF Southeast Asia

Cover artwork:

Hulaesudin and Desi Suyamto, ICRAF Southeast Asia

Cover picture:

Nere and millet parkland systems in Sapone, Burkino Faso - Jules Bayala (INERA - Burkino Faso)

Acknowledgement

This publication is an updated manual for WaNuLCAS version 3.01. The content of this manual largely based from version 2.0 and 3.0.

WaNuLCAS model and manual of version 3.0 was exclusively released on CD to accompany the book "Belowground Interactions in Tropical Agroecosystems: Concepts and models with Multiple Plant Components" published by CAB International.

This manual is funded by the Department for International Development of the United Kingdom. However, the Department for International Development can accept no responsibility for any information provided or view expressed.

The authors wish to acknowledge valuable inputs and advice from many colleagues over the last four years. Earlier versions of the WaNuLCAS model and manual were used by a number of users and this lead to valuable feedback.

Dr. Jules Bayala, Dr. Catherine Muthuri, Dr. Simone Radersma, Dr. Didik Suprayogo, Rachmat Mulia and Dr. Christian Dupraz have contributed to specific model sectors.

Dr. Luis Fernando Guedes-Pinto, Johan Iwald, La Nguyen, Lina Nolin and Carina Ortiz have provided useful comments and feedback that build into the current version.

Previous version of the manual and the model have received valuable feedbacks from Dr. Peter de Willigen (AB-DLO Haren, the Netherlands) and Dr. Georg Cadish (Wye College, UK) in the context of the Biological Management and Soil Fertility (BMSF) Project. Dr. Richard Coe, Dr Quirine Ketterings and Dr. Edwin Rowe have also contributed to specific model sectors.

The feedback of all trainings and courses participants in UK (Agroforestry Modelling Project funded by Forestry Research Program/DFID-FRP), Bogor, Bandar Lampung, Chiang Mai, Claveria, Guadaloupe, Los Banos, Malang, Nairobi, and Turrialba, are gratefully acknowledged.

Table of contents

Chapter 1. Introduction and objectives	1
1.1 Balancing pattern and process	3
1.2 Tree-soil-crop interactions	5
1.3 Intercropping, crop-weed and agroforestry models	8
1.4 Objectives of the WaNuLCAS model	10
Chapter 2. Overview of the model	17
2.1 Model features	19
2.2 Model organization	22
Chapter 3. Description of model sectors	27
3.1 Agroforestry systems	29
3.2 Soil and climate input data	34
3.3 Water balance	40
3.4 Nutrient (nitrogen and phosphorus) balance	52
3.5 Root distribution	64
3.6 Light capture	70
3.7 Crop growth	73
3.8 Tree growth	80
3.9 Carbon Balance	90
3.10 Management options	93
3.11 Model Output	98
Chapter 4. Examples of model applications	103
4.1 Simulation based on default parameter settings	105
4.2 The use of the main switches and changes in crop or tree type	107
4.3 Crop-only controls with N and P fertilizer	111
4.4 Hedgerow intercropping: pruning regime and hedgerow spacing	114
4.5 Tree fallow – crop rotations	117
4.6 Contour hedgerows on sloping land	120
4.7 Tree-soil-crop interactions across a rainfall gradient	122
4.8 Model parameter sensitivity for P uptake	125
4.9 Hedgerow intercropping: safety-net function of tree roots	125
4.10 Water and Nutrient Use efficiency in Agroforestry Systems	127
4.11 Management options for agroforestry parkland systems in Sapone (Burkina Faso): separating the tree-soil-crop interactions using WaNuLCAS	128

4.12 Long time effect of Legume Cover Crop (LCC), sugarcane harvest residue (trash) and Bagas (sugarcane processing waste) on soil carbon and sugarcane yield	131
4.13 The effect of agroforestry systems based on differing leaf phenologies on water balance and tree and crop growth	134
4.14 Safety net efficiency - effect of root length density and distribution	134
4.15 Tree root systems dynamic - root functional and local response	137

Appendixes

Appendix 1 Introduction to STELLA	143
Appendix 2 User's guide to WAnuLCAS	149
Appendix 3 Description on Excel files accompanying WaNuLCAS model	161
Appendix 4 List of output acronyms and definition	169
Appendix 5 Deriving uptake equation (P. de Willigen)	179
Appendix 6 Trouble-shooting and tips	181
Appendix 7 Input parameters and their definition	185
Appendix 8 Other Useful parameters and their definition	235

References 241

Chapter 1

Introduction and Objectives

This background document is written for two groups of readers:

- 1. Agroforestry researchers who are not very familiar with modelling or with quantitative descriptions of resource capture in agroforestry, but who may be tempted to use the model as part of their toolbox, for exploring new variants of agroforestry system before they embark on field experimentation,*
- 2. Modellers who know little about agroforestry but a lot about component processes and who may find in WaNuLCAS a framework for exploring the system context of their favoured aspect of tree-soil-crop interactions.*

The text of this background documentation is organized as follows:

Chapter 1: discusses some general considerations about agroforestry modelling which have lead to the development of WaNuLCAS,

Chapter 2: sketches an outline of the program to provide an overview of the components and the possibilities for use,

Chapter 3: gives a more detailed account, sector by sector of the specific assumptions made for the model and of the options provided for the model user,

Chapter 4: gives a number of worked-out examples of model applications

The appendices give detailed instructions on how to get the model started, suggest exercises to familiarize oneself with the model and provide descriptions of the model parameters.

1.1 Balancing pattern and process

A focal point in the analysis of where and how agroforestry systems work is still whether or not tree-crop systems can utilize resources of light, water and/or nutrients which would not be used in a simpler tree or crop system (Cannell *et al.*, 1996). A fair amount of detail in the description of above- and belowground resource capture by the component species is needed to evaluate both competition and complementarity (Sanchez, 1995; Ong and Huxley, 1996).

Tree-soil-crop interactions occur both in space and time. In 'sequential' agroforestry systems neighbourhood effects in a landscape mosaic still have a spatial element, while 'simultaneous' systems often have at least an element of zonation. The dichotomy between sequential and simultaneous agroforestry systems may thus have been overstated in the past and a modelling framework is desirable in which they are endpoints of a continuum.

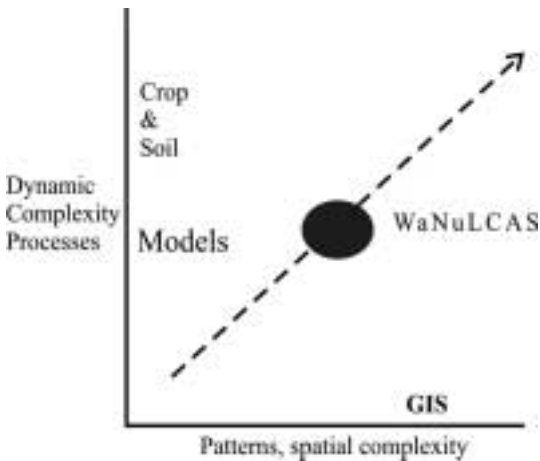

Figure 1.1 Schematic classification of the way crop growth models deal with spatial and temporal complexity; agroforestry models should explore the diagonal, rather than try to introduce spatial patterns in complex process based models

In modelling agroforestry systems, a balance should be maintained between 'process' and 'pattern', between temporal and spatial aspects (Fig. 1.1). Existing crop growth models tend to be detailed in 'processes', but they usually do not take spatial patterns into account. They (implicitly) assume a homogeneous 'minimum representative' area, with a one-dimensional variation between soil layers. Most GIS (geographical information systems) applications do not incorporate spatial interactions and estimate the total

output of an area as the summation of area times output per unit area, for grid cells which are not dynamically interacting with their neighbours (similar to a 'stratified' sampling approach). For representations of agroforestry we need both spatial and dynamic aspects, and should therefore aim at models along the diagonal line in Fig. 1.1. Full-scale detail on spatial interactions may not be achievable for any reasonable process description, however, and it may be best to start in the lower left corner with fairly simple process and spatial descriptions, only to move to the upper right corner where research questions require more detail. As a starting point on the spatial side, we have chosen for a system of 'zoning', which can relate many types of spatial patterns to a model still covering essential aspects of real-world behaviour. Spatial interactions, such as shading aboveground and competition for water and nutrients belowground may occur over a range of distances. Instead of a black/white sharp boundary, every tree-crop interface may consist of several shades of grey in between. The zoning system we opt for appears to have the minimum complexity to do justice to such interactions.

In simultaneous agroforestry systems, trees and food crops are interacting in various ways. As both positive and negative interactions occur, optimization of the system will have to be site specific. The most important interactions probably are:

1. Shading by the trees, reducing light intensity at the crop level,
2. Competition between tree and crop roots for water and/or nutrients in the topsoil,
3. Mulch production from the trees, increasing the supply of N and other nutrients to the food crops,
4. Nitrogen supply by tree roots to crop roots, either due to root death following tree pruning or by direct transfer if nodulated roots are in close contact with crop roots,
5. Effects on weeds, pests and diseases,
6. Long term effects on erosion, soil organic matter content and soil compaction.

Interactions 3, 4 and 6 are positive, 1 and 2 are normally negative, and 5 can have both positive and negative elements. The positive and negative effects can interact during the growing season, and this may limit the use of end-of-season summaries of the tree-crop interaction effects. Yet, such summaries are helpful as a first approximation.

1.2 Tree-soil-crop interactions

The success of any intercropping depends on the balance of positive (facilitation) and negative (competition) interactions between the components Vandermeer (1989). Ong (1995) and Akeampyong *et al.* (1995) developed a simple equation for quantifying tree-soil-crop interactions (I), distinguishing between positive effects of trees on crop growth via soil fertility improvement (F) and negative effects via competition (C) for light, water and nutrients. Very much simplified, the interaction term is positive and the combined system may make sense if $F > C$, and not if $F < C$.

Cannell *et al.* (1996) attempted to clarify the resource base of the production by both the crop and the tree. Part of the 'fertility' effect of the tree is based on light, water and nutrient resources which the tree acquired in competition with the crop (F_{comp}); another part may have been obtained in complement to resources available for the crop (F_{noncomp}). Similarly, part of the resources acquired by the tree in competition with the crop is recycled within the system and may thus be used by a future crop (C_{recycl}). Tree products that are not recycled may have direct value for the farmer ($C_{\text{nonrecycl}}$).

One may argue that F_{comp} is based on the same resources as C_{recycl} and that in the longer run the two terms would cancel. The question whether or not a tree-crop combination gives yield benefits then depends on:

1. the complementarity of the resource use,
2. the value of direct tree products, specifically those obtained in competition, $C_{\text{nonrecycl}}$, relative to the value of crop products that could have been produced with these resources.
3. the efficiency of recycling tree resources into crop products, specifically for the resources obtained in competition with the crop, C_{recycl} .

Apart from yield effects of agroforestry, labour requirements have a strong impact on profitability, and for this one should compare additional labour use (eg. tree pruning) and labour saving aspects (eg. weed control). Complementarity of resource use can be based on a difference in timing of tree and crop resource demand. If the tree picks up the 'left overs' from the cropping period, as occurs with water in the *Grevillea* maize systems in Kenya (Ong; pers. comm.) and transforms these resources into valuable products, a considerable degree of competition during the temporal overlap may be acceptable to the farmer. If tree products have no direct value, agroforestry systems may only be justified if $F_{\text{noncomp}} > C_{\text{nonrecycl}}$. With

Table 1.1 Three-step approach to analysis and synthesis of tree-soil-crop interactions in simultaneous agroforestry systems. A direct experimental separation of the terms in the equation is combined with quantification of key processes and followed by model synthesis to explore management options and system-site matching (van Noordwijk *et al.*, 1998a).

$Y_c =$	$Y_0 +$	$F_1 +$	$F_{\infty} +$	$C_1 +$	$C_{w+n} +$	M
Crop yield in interaction	Crop yield in monoculture	Direct fertility effect	Long term fertility effect	Competition for light	Competition for water and nutrients	Micro-climate effects
<i>1. Experimental</i>		Mulch transfer	Residual effect	Tree removal	Root barriers	
<i>2. Process-level understanding</i>		Litter quality, mineralization rates	Functional SOM fractions (Ludox)	Canopy shape, light profiles	Root architecture (fractal branching analysis)	
<i>3. Synthesis model</i>	W a N u L C A S					

increasing direct value of the tree products, the requirements for complementarity decrease.

The efficiency of recycling will depend on the degree of synchrony between mineralization from these organic residues and crop nutrient demand, as well as on the residence time of mineral nutrients in the crop root zone under the site-specific climate and soil conditions (De Willigen and Van Noordwijk, 1989; Myers *et al.*, 1994, 1997).

As light is not stored in ecosystems, complementarity in light use is easy to measure. For water and nutrients complementarity has to consider time scales linked to the 'residence' times of the resources in the ecosystem; residence times tend to increase from water, via nitrogen and potassium to phosphorus. For P resources used by the tree it will be difficult to measure whether or not this P might have become available to the crop in the absence of trees. Indications of complementarity in belowground resource use can be obtained by observing the root distribution of both components. Actual uptake of resources will, however, depend on resource and root distribution as well as demand factors, and thus the degree of overlap in root distribution per se is not sufficient to predict competition.

Van Noordwijk (1996a) presented explicit algebraic solutions for an agroforestry model which links both the mulch production and its ensuing soil fertility effect and the shading which is assumed to have a negative effect on crop yields to the biomass production of the tree. The model leads to a

simple mulch/shade ratio as a basis for comparing tree species. The model also predicts that at low soil fertility, where the soil fertility improvement due to mulch can be pronounced, there is more chance that an agroforestry system improves crop yields than at higher fertility where the negative effects of shading will dominate. The mulch/shade model, however, does not incorporate the interactions between water availability, N dynamics, crop and tree growth. Incorporating these elements on the basis of a daily time step extends the model beyond what can be solved explicitly and into the realm of dynamic simulation models, which keep track of resource stocks outside and inside the plants and use these to calculate daily resource flows and daily resource capture.

The tree-soil-crop interaction equation can be further analyzed by differentiating between short and long term fertility effects (F_1 and F_∞ , respectively) and by separating the competition term in an above- and a belowground component (C_1 and C_{n+w} , respectively). Van Noordwijk *et al.* (1998a) described a three-step approach to link these overall terms to experimental treatments, process research and WaNuLCAS as a synthesis model (Table 1.1). The total balance for belowground resources (water or nutrients) inputs into an agroforestry system is (Table 1.2):

$$\Delta \text{Stored} = \text{Input} + \text{Re cycle} - \text{Upt}_{\text{crop}} - \text{Upt}_{\text{tree,comp}} - \text{Upt}_{\text{tree,noncomp}} - \text{Loss} \quad [1]$$

The term $\text{Upt}_{\text{tree,noncompetitive}}$ represents the safety net function of tree roots for nutrients and water leaching and percolating below the zone of crop roots and/or outside of the crop growing season (Van Noordwijk *et al.*, 1996), as well as a nutrient pump role for resources stored in the subsoil for longer periods of time (Young, 1997).

In summary, we argue that agroforestry systems do not make much sense from a biophysical point of view, unless there is at least some complementarity in resource capture. Direct empirical approaches to quantify complementarity are possible for aboveground processes, but more complex belowground, as resources there are stored over a longer period of time, making it more difficult to judge whether or not resources could have been used outside an agroforestry context. Models of tree-soil-crop interactions have to pay specific attention to the depth from which each component is capturing water and nutrients on a daily basis, in order to derive overall complementarity on a seasonal basis.

Table 1.2 Representation of resource capture (equation 1) in a simple tree-crop agroforestry system, where the crop roots are confined to the 'topsoil' and the tree roots explore the 'subsoil' as well; the subscripts 1, 2 and 3 refer to crop zones with increasing distance to the tree.

Term in eq. 1	Water	Nitrogen	Light
Input	Rainfall, irrigation runon-runoff	Fertilizer & organic imports	Sum of daily radiation
Recycle	Hydraulic lift into crop root zone	Litterfall, tree prunings, crop residues	-
Uptake _{Crop}	$\Sigma W_{\text{Uptakecrop}}$	$N_{\text{fix}}(\text{Crop}) + \Sigma N_{\text{Uptakecrop}}$	$\Sigma \text{Lightcap}_{\text{crop}}$
Uptake _{Tree, Competitive}	$\Sigma_{\text{sub}} W_{\text{Uptaketree}}$	$\Sigma_{\text{top}} N_{\text{Uptaketree}}$	$\Sigma \text{Lightcap}_{\text{tree}_{1,2}}$
Uptake _{Tree, Noncomp}	$\Sigma_{\text{sub}} W_{\text{Uptaketree}}$	$N_{\text{fix}}(\text{Tree}) + \Sigma_{\text{sub}} N_{\text{Uptaketree}}$	$\text{Lightcap}_{\text{tree}_3}$
Losses	Σ Percolation from lowest zone	Σ Leaching from lowest zone	$1 - \Sigma \text{Lightcap}$
Δ storage	Δ Water content	$\Delta(N_{\text{min}} \& \text{SOM})$	-

1.3 Intercropping, crop-weed and agroforestry models

Attempts to link separately developed crop models into an 'intercropping' model have not been very successful yet (Caldwell *et al.*, 1996). A possible reason for this is that accurate description of both above- and below ground resource capture is more critical in a competitive situation than in a monoculture. Aboveground canopy structure does not matter in a monoculture as long as total LAI is predicted correctly. A coarse approximation of the allocation of current uptake of water and nutrients from the soil profile can be good enough, if the resources not used today still remain in the soil on the next day. In a competitive situation, however, it matters where the leaves of each component are relative to those of other components; belowground resources not utilized today may have been taken up by other components before tomorrow. It thus appears that a reasonable performance of a crop growth model in a monoculture situation is a necessary condition for expecting it to perform in intercropping, but not a sufficient condition. Additional detail may be needed to get above- and belowground resource capture correct.

Kropff and Van Laar (1993) gave an overview of models for crop-weed interactions: such models tend to emphasize the phenology of the species competing for resources, as they are meant to help in predicting the effect of interventions (weeding) at different points in the crop life cycle. Otherwise, crop-weed models differ only in name from intercropping models, as both describe resource capture in a system where at least two plants are interacting.

In intercropping models, however, both components have direct value to the farmer, whereas in crop-weed systems the 'weeds' have no direct value at all (although they may help in conserving nutrients in the system and reducing losses by leaching). Agroforestry models have to include a two-plant interaction (Fig. 1.2), similar to intercropping and crop-weed models, but differ in that one of the plants is a perennial species. Part of the inspiration for an agroforestry model may thus come from existing tree or forest models.

Rather than linking existing tree and crop models, an alternative approach is to develop a generic plant-plant interaction model. The focus should be on above- and belowground resource capture and its interplay (Fig. 1.3). Specific parameters for each component can be derived from more specialized component models, such as drivers for physiological development (onset of flowering, internal redistribution in generative stage). The model should, however, give a fair description of 'architecture' (spatial distribution of the relevant organs) above- and belowground and their consequences for uptake. A correct account of the spatial distribution of organs for resource capture is probably more important in plant-plant interaction models than it is in models for monocultural stands.

A major problem in linking a number of single-species resource capture models into a multi-species resource capture model with a single accounting systems for the resources, is one of priority assignment in the calculation sequence. Models which consistently assign priority to one of the components may vastly overestimate its resource capture, while the solution of some models of alternating priorities is not very satisfactory either (Caldwell *et al.*, 1996).

For a more balanced approach, the resource capture of the various components should be further integrated and applied simultaneously, avoiding priority assignment. One way of doing this is adding the root (for water and nutrients) and leaves in a common layer or zone, calculating a total resource capture and sharing this out over the two (or more) components in proportion to their root length density or leaf area. As

resource capture is in most cases a non-linear function of root length or leaf area, this approach to resource sharing gives a different result from adding resource capture for the two components (the latter may overestimate potential uptake rates).

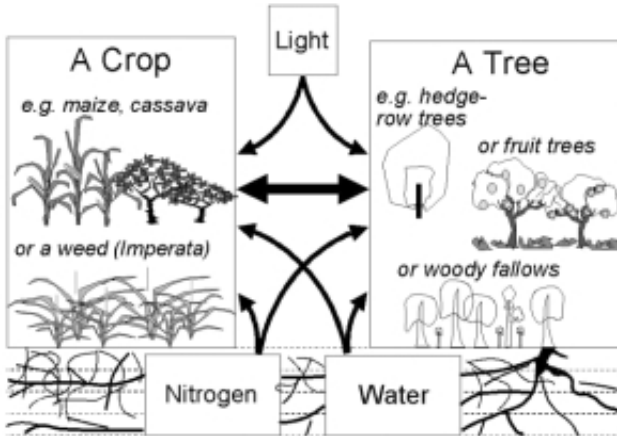

Figure 1.2 Components of the WaNuLCAS model

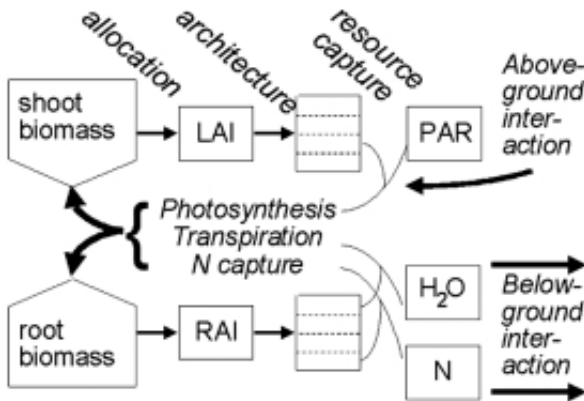

Figure 1.3 Resource capture framework for modeling plant growth, based on shoot and root biomass, allocation to leaf and root area index (LAI and RAI, respectively) and its spatial distribution (based on 'architecture') and capture of light, water and nutrients; aboveground plant-plant interactions modify resource flow, belowground they modify stocks

1.4 Objectives of the WaNuLCAS model

In developing a generic model for water, nutrient and light capture in agroforestry systems (WaNuLCAS), we aimed at a model which would:

1. integrate knowledge and hypotheses on below and aboveground resource capture by trees and crops (or any two or more types of plants)

- at patch scale (the smallest 'self-contained' unit for describing the tree/crop interaction) as a basis for predicting complementarity and competition,
2. build on well-established modules (models) of a soil water, organic matter and nitrogen balance, and crop and a tree development to investigate interactions in resource capture,
 3. describe the plant-plant interaction term as the outcome of resource capture efforts by the component species, as determined by their above- and belowground architecture (spatial organization) as well as physiology,
 4. be applicable to spatially zoned agroforestry systems as well as rotational systems,
 5. avoid where possible the use of parameters which can only be derived by fitting the model to empirical data sets and maximize the use of parameters which can be independently measured
 6. be flexible in exploring management options within each type of agroforestry system,
 7. be useful in estimating extrapolation domains for 'proven' agroforestry techniques, as regards soil and climate properties, as well as tree and crop architecture,
 8. be user-friendly and allow 'non-modelers' to explore a range of options, while remaining open to improvement without requiring a complete overhaul of the model,
 9. generate output which can be used in existing spreadsheets and graphical software,
 10. make use of readily available and tested modeling software.

In view of objectives 8, 9 and 10 we chose the Stella Research modeling shell (Hannon and Ruth, 1994) linked to Excel spreadsheets for data input and output. The current model should be seen as a prototype; in the Stella environment it is relatively easy to modify or add modules or relationships.

Models can be of value ('validated' in the original sense of the word) if a) they adequately reflect the major assumptions one would like to make about component processes, if b) they operate smoothly in the parameter range where one would like to use them, and/or if c) their quantitative predictions agree with measured results in specific experiments (Van Noordwijk, 1996b). Before model validation is undertaken, (1) the purpose of the model, (2) the performance criteria and (3) the model context must be specified (Rykiel, 1996). At this stage we have concentrated on levels a and b

of the validation process. WaNuLCAS model is meant as a prototype model, not including all possible tree-soil-crop interaction relationships that one can imagine, but incorporating a core of relations which we are fairly sure of for each specific case. In this sense the model can be viewed as a 'null model' (Gotelli and Graves, 1996) which can be used like a null hypothesis as a background against which specific data sets can be tested. The open modeling frame will allow users to add other relationships when and where they wish. Muetzelfeldt and Taylor (1997) have translated WaNuLCAS into a new modelling platform Agroforestry Modeling Environment (AME) as a platform. This modelling environment is now called SIMILE and is currently used in developing FLORES model. The European sylvo-arable agroforestry project SAFE is developing a model with greater spatial articulation HiSAFE.

Further information on agroforestry models can be found on the following web sites:

<http://www.montpellier.inra.fr/safe/> for news on the HiSAFE model currently under development

<http://www.wiz.uni-kassel.de/ecobas.html> for database of ecological models

<http://www.ierm.ed.ac.uk/simile/> for Simile - previously named AME - Agroforestry Modelling Environment

<http://simulistics.com/projects/flores/> for FLORES model

[http://www.forestresearch.co.nz/topic.asp?topic=AEM&title=Agroforestry %20Estate%20Model](http://www.forestresearch.co.nz/topic.asp?topic=AEM&title=Agroforestry%20Estate%20Model)

for Agroforestry Estate Model, a Windows application which projects physical and financial yields for an agroforestry project

Intermezzo: Plant -- a first exploration of a dynamic plant growth model in the STELLA environment

In making a simulation model you can start with an empty sheet of paper or screen, draw a key variable in the centre, consider its inputs and outputs, and the various influences on those inputs and outputs...

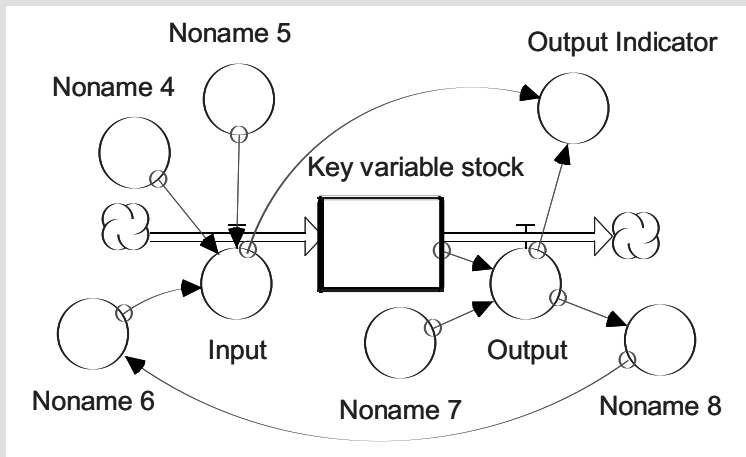

You may realize that you are specifically interested in the 'efficiency' or rate of output per rate of input of the key variable, so this becomes your main output indicator. On further thought, one of factors that is influenced by the 'output' has a feed-back effect on one of the influences on the 'input'. The conceptual model starts to grow, and it becomes a little complex to imagine how the overall output indicator will respond to the various influences that you have recognized. You may want to see it change before your eyes. Wait, we cannot run the model yet, as we first have to specify what these red arrow mean: influences on a process need to be combined in the form of an 'equation'....

In a nutshell, the above process describes how a model such as WaNuLCAS started. But it has grown so complex that the origin is difficult to trace. In the following description of a basic 'PLANT' model, we introduce a couple of key concepts that are used in more elaborate form in the tree-soil-crop interaction model. PLANT follows the day-to-day development of a plant with leaves, roots, flowers and seeds. The plant takes up water from the soil, that comes from a stock of 'available water' replenished by rainfall. The plant also takes up and thus depletes a stock of soil nutrients. Its rate of photosynthesis is the prime driver of all growth, and requires the combination of light, atmospheric CO₂, stomata that can be open (so water stress shouldn't be too severe) and leaves that are green (so there is enough nitrogen and other nutrients to make the required enzymes and cell structures).

In describing how plants grow we can thus start with the concept of 'photosynthesis' that generates carbohydrate reserves that can be used to make either 'shoot' or 'root' tissues and adds to their dry weight. We can distinguish between a potential rate of photosynthesis that depends on factors such as CO₂ concentration, light and temperature, and an actual one, that can be reduced by water or nutrient stress. An important thing to consider is the development of the plant from vegetative to generative (flowering and fruit production) phases - we may be able to link this 'phenological development' to a temperature-sum that keeps track of the past weather, plus parameters for the thresholds of flowering and fruit(seed) ripeness.

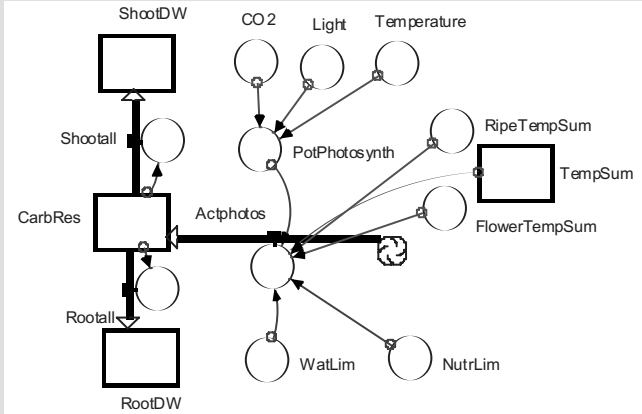

Hey, we're missing something important. Photosynthesis depends on the green leaf area exposed to light - so we need to relate the 'dry weight of shoot' to the leaf area available. Similarly, we need to specify how root dry weight is related to the WatLim and NutrLim parameters that describe growth-limiting degrees of water and nutrient stress....

That means we need to add a stock that represents soil water and is replenished by rainfall.

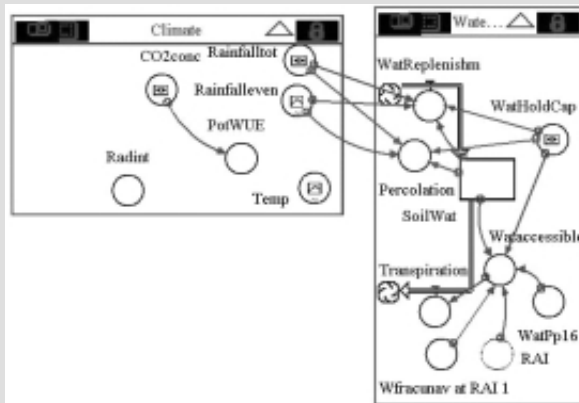

After adding these other stocks and flows, our 'simple model' starts to look complicated... but it is now possible to 'run' it, as we have specified all relationships.

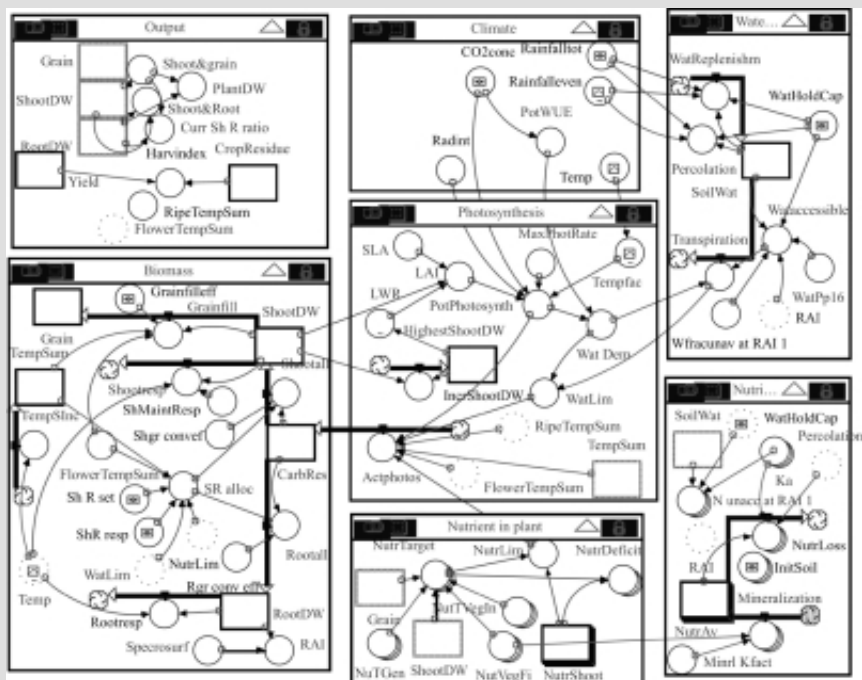

Finally, we go the 'upper' screen and add some sliders for easy modification of input parameters, graphs for daily rainfall and temperature input, and buttons for run control. As outputs there is a stack of graphs and indicators of some of the ratios such as current shoot: root ratio and harvest index. The model is there to be explored, improved, used, expanded...

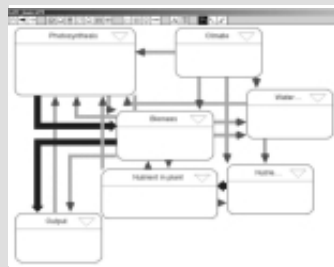

Sector map

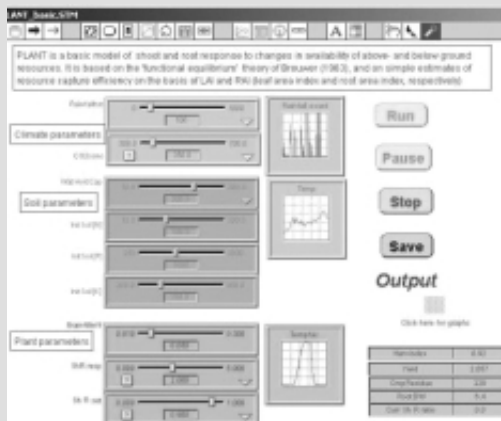

Control screen

Chapter 2

Overview of the model

Before we give a detailed description of model assumptions and formulation in chapter 3, we will give an overview of the model here (Fig. 1.2).

The model is formulated in the STELLA Research modeling environment and thus remains open to modifications. Emphasis is placed on belowground interactions, where competition for water and nutrients (nitrogen and phosphorus) is based on the effective root length densities of both plant components and current demand by tree and crop.

Simulations require the prior definition of a soil profile and its soil physical and chemical properties per layer, of a degree of slope and hence lateral interactions, and of the climate.

Agroforestry systems are defined on the basis of spatial zones and a calendar of events for each zone, including growing and harvesting trees or crops, fertilizer use or slash-and-burn land clearing.

2.1 Model features

A key feature of the model is the description of uptake of water and nutrients (N and P) on the basis of root length densities of the tree(s) and the crop, plant demand factors and the effective supply by diffusion at a given soil water content. De Willigen and Van Noordwijk (1994) and Van Noordwijk and Van de Geijn (1996) described underlying principles.

The model was developed to emphasize the common principles underlying a wide range of tree-crop agroforestry systems in order to maximize the cross-fertilization between research into these various systems and explore a wide range of management options. The model can be used for agroforestry systems ranging from hedgerow intercropping (alley cropping) on flat or sloping land (contour hedgerow intercropping), taungya-type transitions into tree-crops, via (relay-planted) fallows to isolated trees in parkland systems. Figure 2.1 shows the different modules available inside WaNuLCAS model.

Agroforestry systems. The model represents a four-layer soil profile, with four spatial zones, a water, nitrogen and phosphorus balance and uptake by a crop (or weed) and up to three (types of) tree(s). The model can be used both for simultaneous and sequential agroforestry systems and may help to understand the continuum of options ranging from 'improved fallow' via relay planting of tree fallows to rotational and simultaneous forms of 'hedgerow intercropping'. The model explicitly incorporates management options such as tree spacing, pruning regime and choice of species or provenance. The model includes various tree characteristics, such as root distribution, canopy shape, litter quality, maximum growth rate and speed of recovery after pruning.

If applied to hedgerow intercropping, the model allows for the evaluation of different pruning regimes, hedgerow tree spacing and fertilizer application rates. When applied to rotational fallow systems, the 'edge' effects between currently cropped parts of a field and the areas where a tree fallow is growing can be simulated. For isolated trees in parkland systems, equidistant zones around individual trees can be 'pooled' and the system as a whole can be represented by a number of circles (of different radius) with a tree in the middle (further explanation is given in section 3.1).

Climate effects are mainly included via daily rainfall data, which can be either read from a spreadsheet or generated on the basis of daily probability of rainfall and a division between 'heavy', and 'light' rains. Average

temperature and radiation are reflected in 'potential' growth rates. 'Thermal time' is reflected in the speed of phenological development. Soil temperature is explicitly used as a variable influencing decomposition and N and P mineralization.

Soil is represented in four layers, the depth of which can be chosen, with specified soil physical properties and initial water and nitrogen contents.

The **Water balance** of the system includes rainfall and canopy interception, with the option of exchange between the four zones by run-on and run-off as well as subsurface lateral flows, surface evaporation, uptake by the crop and tree and leaching. Vertical as well as horizontal transport of water is included; an option is provided to incorporate (nighttime) 'hydraulic equilibration' via the tree root system, between all cells in the model.

The **Nitrogen and Phosphorus balance** of the model includes inputs from fertilizer (specified by amount and time of application), atmospheric N fixation, mineralization of soil organic matter and fresh residues and specific P mobilization processes. Uptake by crop and tree is allocated over yields which are exported from the field/patch and recycled residues. Leaching of mineral N and P is driven by the water balance, the N concentrations and the apparent adsorption constant in each layer, thus allowing for a 'chemical safety net' by subsoil nutrient (including nitrate) adsorption.

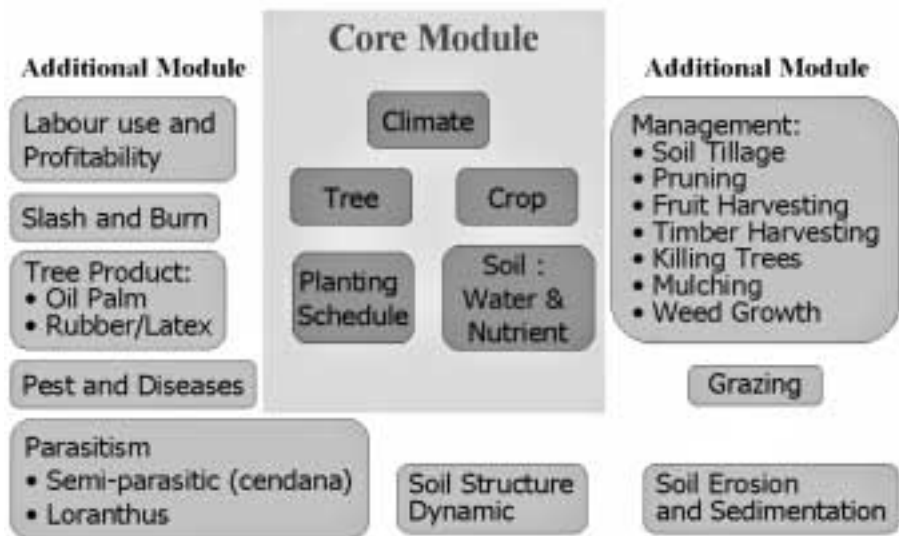

Figure 2.1 Schematic diagram of different modules inside WaNuLCAS model.

Growth of both plants ('crop' and 'tree') is calculated on a daily basis by multiplying potential growth (which depends on climate) with the minimum of four 'stress' factors, one for shading, one for water limitation, one for nitrogen and one for phosphorus. For trees a number of allometric equations (which themselves can be derived from fractal branching rules) is used to allocate growth over tree organs.

Uptake of both water and nutrients by the tree and the crop is driven by 'demand' in as far as such is possible by a zero-sink uptake model on the basis of root length density and effective diffusion constants:

$$uptake = \min(demand, potential\ uptake) \quad [2]$$

For water the potential uptake at a given root length density and soil water content is calculated from the matric flux potential of soil water.

Demand for nitrogen uptake is calculated from empirical relationships of nutrient uptake and dry matter production under non-limiting conditions¹, a 'luxury uptake'², a possibility for compensation of past uptake deficits and an option for N fixation (driven by the Ndfa parameter, indicating the part of the N demand which can be met from atmospheric fixation).

Competition for water and nutrients is based on sharing the potential uptake rate for both (based on the combined root length densities) on the basis of relative root length multiplied by relative demand:

$$PotUpt(k) = \min \left[\frac{Lrv(k) * Demand(k) * PotUpt(\sum Lrv)}{\sum_{k=1}^n (Lrv(k) * Demand(k))}, PotUpt(Lrv(k)) \right] \quad [3]$$

where PotUpt gives the potential uptake rate for a given root length density L_{rv} .

This description ensures that uptake by species k is:

1. proportional to its relative root length density L_{rv} if demand for all components is equal,

¹ The assumptions are 5% N in dry matter up to a closed crop canopy (s reached at an aboveground biomass of about 2 Mg ha⁻¹) and 1%N in new dry matter after that point with target N:P ratio = 10

² An assumption that growth will not be reduced until N content falls below 80% of demand

2. never more than the potential uptake by i in a monoculture with the same L_{rv} ,
3. not reduced if companion plants with a high root length density have zero demand (e.g. a tree just after pruning).

At this stage we apply this procedure to four species ($n=4$, i.e. 3 trees and a crop or weed in each zone), but the routine can be readily expanded to a larger number of plants interacting.

Root growth is represented for the crop by a logistic increase of root length density in each layer up till flowering time and gradual decline of roots after that time. A maximum root length density per layer is given as input. The model also incorporates a 'functional equilibrium' response in shoot/root allocation of growth, and a 'local response' to shift root growth to favourable zones. For the tree, root length density in all zones and layers can be assumed to be constant, thus representing an established tree system with equilibrium of root growth and root decay or can follow dynamic rules roots similar to those for crop.

The **Soil Organic Matter** module includes litter layer and organic matter. Both has three main pools (Active, Slow and Passive), following the terminology and concepts of the CENTURY model.

Light capture. Light capture is treated on the basis of the leaf area index (LAI) of all components and their relative heights, in each zone. Potential growth rates for conditions where water and nutrient supply are non-limiting are used as inputs. This can be potentially derived from other models. Actual growth is determined by the minimum of shade, water and nutrient stress.

2.2 Model organization

Stella allows the user three perspectives on a model:

1. On the upper layer, general information is provided, key parameters can be modified (Fig. 2.2A) and output can be obtained in the form of graphs and tables (Fig. 2.2B). Figure 2.4 shows example of output graphs.
2. On the middle layer (Fig. 2.3 A-B), the model is presented as a complete compartment - flow diagram, with all equations entered at the respective 'converters'; double arrows indicate 'flows' from 'pools' in rectangles, while single lines indicate a flow of information; this is the working level for developing or modifying the model; a 1:1 relation is maintained between the diagram and the model relationships,

3. A listing of the model equations, with comments added.

At the middle level, the model can be arranged in sectors. To facilitate the process of finding parameters in the model, we made sure that all parameters in a sector start with letters referring to the sector. This way, an alphabetic listing of parameters as the Stella shell does, gets functional significance. In chapter 3 we will start using the names of model parameters in WaNuLCAS. A selection of parameters (all those which are important as input values to be specified by the user) is given in Appendix 7.

In Stella multiple representations of similar structures can be obtained by using arrays. In WaNuLCAS we use arrays for the 'zones' and in some cases, for the different soil layers. We also use arrays for nutrients (N and P) as they can be treated in parallel. Despite the symmetry in the uptake description between water and nitrogen, we found that there are enough differences to merit separate representation in the model, rather than a generic 'belowground resources'. A number of parameters dependent on crop type are in an array called 'crop', and are utilized based on the crop sequence specified (see 3.1.3). To find out the various arrays used in the model, see the array editor within the STELLA model.

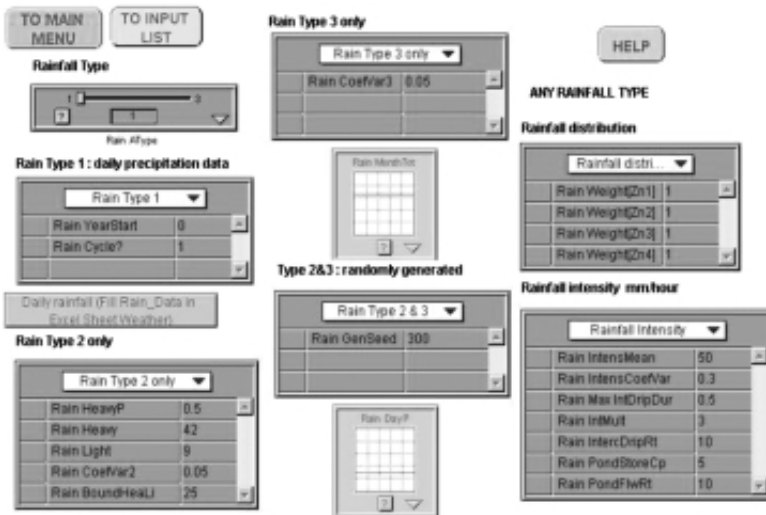

Figure 2.2A Upper level view on the WaNuLCAS model options for setting input values numerically or in graph (table) form; the buttons 'to main menu' and 'to input list' allow one to navigate through the input section

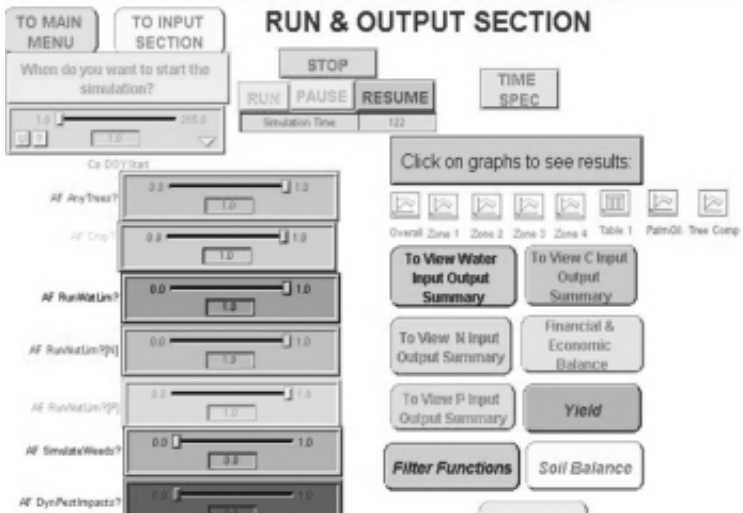

Figure 2.2B Upper level view on the WaNuLCAS model with example of output graphs and tables



Figure 2.3A A Middle level overview of the WaNuLCAS model in version 1.2

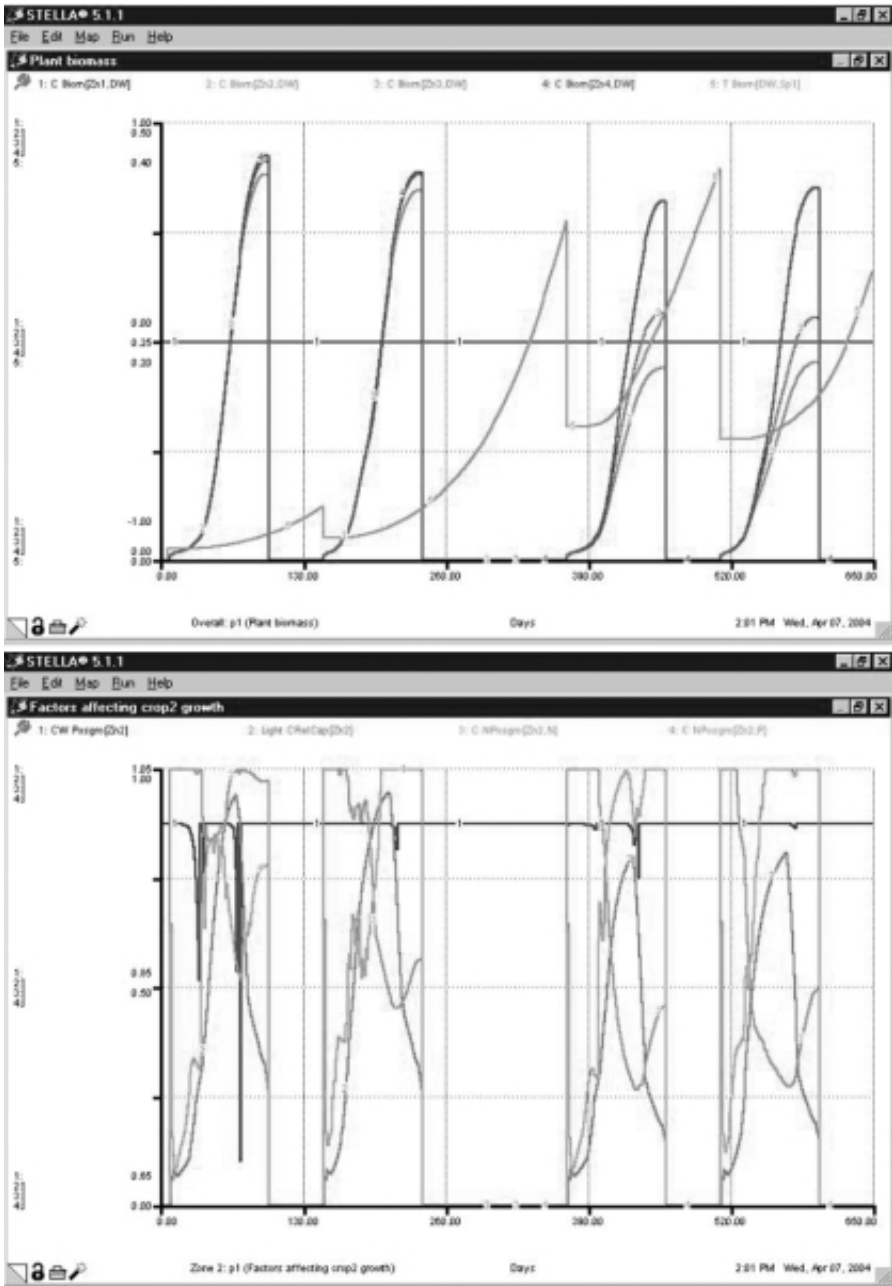

Figure 2.4 Example of output graphs

Chapter 3

Description of model sectors

Confidence in the use of a model may be based on:

- 1. accepting the main assumptions made as reasonable first approximations,*
- 2. the use of reasonable parameter values, and/or*
- 3. a proven ability of the model to predict measured outputs on the basis of appropriate input parameters.*

We will focus here on a description of the model structure chosen and its underlying assumptions.

Parameter names in WaNuLCAS always start with the first 1 or 2 letters of the sector in which they are placed. In this text, however, some of the parameter names are reduced to their core to make equations more readable. Please refer to Appendix 7 for the full list of parameters name.

3.1 Agroforestry Systems

3.1.1 Zoning of the agroforestry system into four zones.

Normally, the first zone will be used for trees only. The other three zones will normally be used for growing crops, but they can be shaded by the trees in zone 1 (depending on canopy size and shape) and can harbour tree roots, leading to belowground competition. Normally the intensity of interactions will decrease from zone 2 to 4. Trees can be planted in zone 1 or zone 4 only (Fig. 3.1).

Table 3.1 Characteristic settings for nine types of agroforestry system.

	Geometry	Tree position, canopy	Topsoil depth	Water infiltration	Time sequence
Alley cropping on flat land	Linear, half alley + hedgerow	Zone 1, Zone 1 - 4	Homogeneous	Homogeneous, except for canopy interception	Continuous
Alley cropping on flat land, alternating hedgerow	Linear, alley + two hedgerows	Zone 1 + 4, Zone 1 - 4	Homogeneous	Homogeneous, except for canopy interception	Continuous
Alley cropping on slopes	Linear, alley + one hedgerow	Zone 1 + 4, symmetrical canopy	Gradient	Heterogeneous (-run off + run-on)	Continuous (soil redistribution can be simulated)
Taungya transition into tree crops	Linear	Zone 1 + 4, Zone 1 - 4	Homogeneous	Homogeneous, except for canopy interception	Continuous
Agroforestation of <i>Imperata</i> grasslands	Linear, start with <i>Imperata</i> as 'crop'; half or whole alley	Zone 1 (+4), Zone 1 - 4	Homogeneous	Homogeneous, except for canopy interception	Continuous
Coffee+shade trees	Linear, use coffee as 'crop'	Zone 1 (+4), Zone 1 - 4	Homogeneous	Homogeneous, except for canopy interception	Continuous
Homegarden	Linear or Circle	Zone 1 (+4), Zone 1 - 4	Homogeneous	Homogeneous	Continuous
Parkland trees	Circle	Zone 1, Zone 1 - 4	Homogeneous	Heterogeneous	Continuous
Tree fallow/ mosaic	Linear	Zone 1, (fallow plot size)	Homogeneous	Homogeneous	Continuous or Switching between fallow and crop stage

Where topsoil depth is varied between zones one should observe constraints so that average topsoil depth over the slope remains realistic (compare 3.2.6).

The model calculates mass balances for a basic unit of area (say 1 m²) in each zone or as (weighted) average for the whole system simulated. A weighted average is used, for example for expressing total yields of the system on an area basis, when accounting for tree roots and their uptake from the various zones. The relative weights are $AF_ZoneFrac[Zn_i]$ and are calculated such that they add up to 1.0.

The four $AF_ZoneFrac[Zone]$ values are calculated from the following four input values:

$AF_Zone[Zn_1]$, $AF_Zone[Zn_2]$, $AF_Zone[Zn_3]$ and $AF_ZoneTot$.
 $AF_Zone[Zn_4]$ is calculated by difference.

For example:
$$AF_ZoneFrac[Zn_1] = \frac{AF_Zone[Zn_1]}{AF_ZoneTot} \quad [4]$$

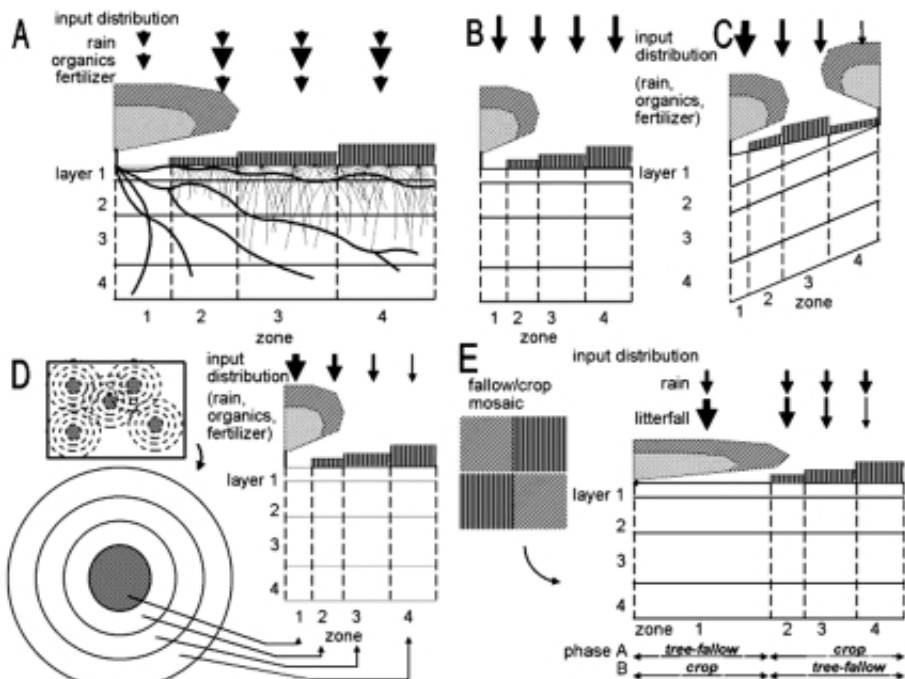

Figure 3.1 General lay out of zones and layers in the WaNuLICAS model (A) and applications to four types of agroforestry system: B. Alley cropping, C. Contour hedgerows on slopes, with variable topsoil depth, D. Parkland systems, with a circular geometry around individual trees, E. Fallow-crop mosaics with border effects.

If a circular geometry is used (AF_Circ = 1), the AF_ZoneFrac[Zone] values are derived from the AF_Zone[Zone] differently (on the basis of circle rings, $(r_i^2 - r_{i-1}^2) / r_4^2$), but otherwise the model can run in the same way. The user has to specify four depths (thickness) of layers under the parameter name AF_DepthLay*i*. The layers will be homogeneous for four zones in each layers.

3.1.2 Input weighting factors

A number of inputs to the soil surface can be distributed homogeneously (proportional to the respective AF_ZoneFrac values), or heterogeneously. This way, we can for example account for. The model expects four input values 'Rain_Weight[Zn i]' and calculates effective weights from:

$$RainWeightAct [Zni] = \frac{RainWeight [Zni]}{\sum_1^4 AFZoneFrac [Zni] * RainWeight [Zni]} \quad [5]$$

This equation ensures that the average rainfall remains at the value specified; the units for the RainWeightAct parameters are arbitrary. Multiplied with the rainfall per unit area (overall average), we then obtain the rainfall per unit area in each zone *i*.

Similar weighting factors are used in T_LitfallWeight, T_PrunWeight for allocating tree litterfall and tree prunings over the various zones, while conserving their overall mass balance. The units for these weighting factors are arbitrary, as they are only used in a relative sense.

3.1.3. Calendar of events

The year in WaNuLCAS starts with Year 0, while the day is value from 1 to 365. Starting day of the simulation can be specified at any time after DOY 1 of Year 0.

Before a simulation, the user can specify a number of events that will take place at a given calendar date usually by specifying the Year and Day-of-Year (DOY) in which they will occur. Some events will be triggered internally, such as crop harvest when a crop is ready for it or a burn event after the slash has dried sufficiently. It may help the model user to design such a calendar. Figure 3.2 and Table 3.2 give an example of calendar of events for a hedgerow systems with Gliricidia as tree and maize -

groundnut as crops. To help users in defining Julian days, we provide a list of Julian days in WaNuLCAS.xls - sheet 'Julian Days'.

Table 3.2. An example of management activities record of a hedgerow systems.

No.	Activities	Date	Year in WaNuLCAS	Day in WaNuLCAS
1.	Planting maize	11 December 1994	0	345
2.	Pruning Glixicidia	8 January 1995	1	8
3.	Maize harvest	10 March 1995	1	69
4.	Pruning Glixicidia	20 March 1995	1	79
5.	Planting groundnut	27 March 1995	1	86
6.	Pruning glixicidia	14 June 1995	1	165
7.	Groundnut harvest	2 August 1995	1	214
8.	Pruning Glixicidia	7 August 1995	1	219

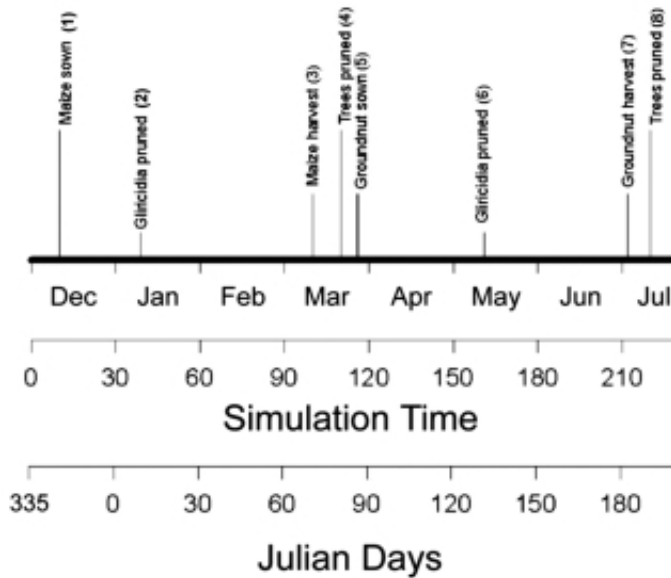

Figure 3.2 A schematic diagram of management activities of a hedgerow systems

3.1.4 Crops, weeds and trees

The model user can schedule a sequence of crops (of different types) to be grown at one time for each zone, with specific fertilizer applications. For each simulation five crop types can be pre-selected from the database in the WaNuLCAS.xls spreadsheet. The crop type to be planted, in a given year and day (within year) can be specified for each zone by modifying the graphs

Ca_CType, Ca_PlantYear and Ca_PlantDoY. Similarly, subsequent fertilizer applications are specified by the graphs Ca_FertOrExtOrgAmount, Ca_FertOrExtOrgAppYear, Ca_FertOrExtOrgAppDoY, Ca_FertApply?, Ca_OrExtOrgApply?.

There is no limit to the number of crops or fertilizer applications specified this way, as the x-axis of the graphs can be extended. A sequencing routine makes sure that crops which have been planted keep priority and new crops can only start after the current one has been harvested (as specified by the duration of its vegetative and generative phases set for the crop type). If a new crop should have been planted before the previous one is harvested, it is skipped from the sequence and the model will wait for the first new planting data specified.

Each crop has a maximum dry matter production rate per day, expressed in $\text{kg m}^{-2} \text{ day}^{-1}$, Cq_GroMax and a graphic input of Cq_RelLUE[Cr*i*] giving the relative light use efficiency as a function of crop stage. These parameters may be derived for a given location from more specific models, such as the DSSAT family of crop growth models or WOFOST (see section 3.7 for further details).

Annual or perennial weeds can be simulated using the 'infrastructure' of the crop model, and a seed bank that allows weeds to regenerate whenever there is no crop cover is included. At the moment, however, no crop-weed interaction within a zone can be simulated (see 3.10.4).

Trees can be planted, pruned and harvested at set calendar dates, using either of the three copies of 'tree' available. Allometric equations, which can be derived from fractal branching rules in a separate spreadsheet, govern the allocation of growth resources over the various tree organs. Trees can be pruned in the model to a specified degree on the basis of a user-specified set of dates (T_PrunY and T_PrunDoY, similar to the crop sequence), or on the basis of one or two criteria: concurrence with a crop on the field and when the tree biomass exceeds a 'prune limit' (see section 3.10.7 for details). Prunings can be returned to the soil as organic input or (partially) removed from the field as fodder.

3.1.5 Animals and soil biota

The model does not at this stage include a livestock component, but it can be used to predict fodder production and the tree pruning rules can be used to describe fodder harvesting or grazing. In such a case external inputs of manure may have to be included.

Soil biota are implicitly accounted for in the parameters of the decomposition model, in the parameters describing the degree of mixing of organic inputs between surface litter and the various soil layers, in the creation of soil macropores (influencing bypass flow) and in N fixation or P mobilization.

3.2 Soil and climate input data

3.2.1 Soil physical properties

For calculating water infiltration to the soil, a layer-specific estimate of the 'field capacity' (soil water content one day after heavy rain) is needed. For calculating potential water uptake a table of the soil's 'matric flux potential' is needed, which integrates unsaturated hydraulic conductivity over soil water content. The model also needs the relationship between water potential and soil water content, to derive the soil water content equivalent to a certain root water potential. As these relationships are not generally measured for all soils where we may want to apply the WaNuLCAS model, 'pedotransfer' functions (Arah and Hodnett, 1997) are used. We derive parameters of the Van Genuchten equations of soil physical properties via a 'pedotransfer' function from soil texture, bulk density and soil organic matter content. The function selected was developed by Wösten *et al.* (1995, 1998). As this pedotransfer function is based on soils from temperate regions, one should be aware of its possible poor performance on soils with a low silt content, as the combination of clay + sand at low silt contents is much more common in the tropics than in temperate regions.

The pedotransfer function is included in the Excel file WaNuLCAS.xls and after the user has specified clay, silt and organic matter content and bulk density of the soil, all the tables are generated which WaNuLCAS needs. The user then has to copy these tables to the sheets representing each zone, replicating them for each layer. This way different soil physical parameters can be used for any layer and zone in the model. Further instructions are given in the spreadsheet itself.

Soil texture	=> Van Genuchten parameters	=> Tabulated water retention, matric flux potential	=> Soil by layer in WaNuLCAS.STM
Soil organic matter			
Soil bulk density			

Suprayogo (2003) produced a pedotransfer database for tropical soils containing 8915 data available worldwide. The data were then used to assess the performance of the pedotransfer function used in WaNuLCAS model in

predicting soil physical relationships (θ -h-K). The results appeared close to the field measurement. The largest deviations occurred on vertisols and mollisols, where bulk density and soil organic matter content diverged.

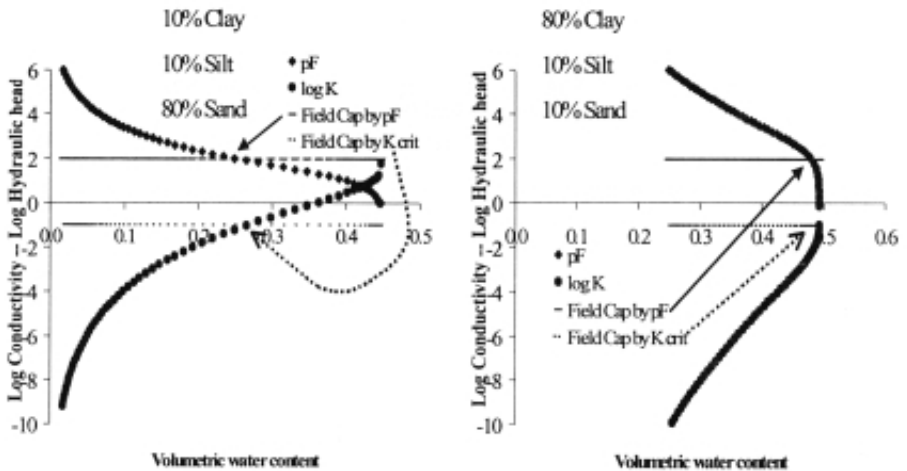

Figure 3.3. Relations between soil water content (X-axis), hydraulic head (expressed as pF or -log(head) -- positive Y axis) and unsaturated hydraulic conductivity (negative Y axis) for a sandy (left) and a clayey (right) soil, based on the pedotransfer function used in WaNuLCAS.XLS; two definitions of 'field capacity' are indicated: one based on a user-defined limiting hydraulic conductivity, and one based on a depth above a groundwater table, defining a pF value; in the model the highest value of the two for each layer and zone will be used to determine maximum soil water content after a heavy rain event

3.2.2 Temperature

Soil Temperature data are used to modify soil organic matter transformations. They can be entered as:

- A. [Temp_AType = 1] as a daily values (Temp_DailyDat) linked to a sheet 'Temperature' in the WaNuLCAS.XLS spreadsheet.
- B. [Temp_AType = 2] a constant (Temp_Cons), or
- C. [Temp_AType = 3] as a table with monthly average values (Temp_MonthAvg)

Air temperature data through C_Topt and C_Tmin parameters are used to modified the length of cropping season. Current default values for air temperature ensure the length of cropping season = Cq_TimeVeg + Cq_TimeGen as specified on WaNuLCAS.xls.

3.2.3 Potential evapotranspiration

There are 2 options for the potential evapotranspiration rate: for Temp_EvapPotConst? = 1 a constant value is used throughout the simulation (Temp_EvapPotConst), while Temp_EvapPotConst? = 0 a daily value (Temp_EvapPotDailyData) is read from the excel spreadsheet. This can be calculated, for example from a (modified) Penman-Monteith equation on the basis of climatological data for the site.

The potential rate of evapotranspiration is used to drive evaporation from canopy interception water (whenever present), trees and crops (but limited by plant water stress if present), dead wood piles on the soil after a slash event and finally by the soil (if any demand is unsatisfied as yet).

3.2.4 Rainfall

Rainfall data can be either generated within WaNuLCAS, or be obtained from an Excel spreadsheet. Setting the 'Rain_AType' parameter makes the choice:

- 1 = Tabulated daily rainfall records from an external file.
- 2 = Random generator
- 3 = Monthly average tabulated data (with given probability of daily rainfall and normal random variation around the average values)

The three options are summarized in Table 3.3.

For choice 1, the data should be copied to sheet 'rainfall' to column 3 of a spreadsheet with name WaNuLCAS.xls. This spreadsheet has in column 1 real dates (optional), in column 2 days {1...end} and in column 3 {rainfall in mm/day}. Alternatively, a new Stella link can be established between the 'Rain data' table in WaNuLCAS and another relevant spreadsheet. Missing data should be addressed outside of WaNuLCAS.

If the user would like to use a different rainfall generator, the easiest way would be to generate rainfall data outside of WaNuLCAS copy the results to the WaNuLCAS.xls spreadsheet and set Rain_AType to 1.

For choice 2, six parameters are needed: the probability of rainfall on a given day RainPday), the probability that rainfall is of type 'heavy' rather than 'light' (Rain_HeavyP), the boundary value of heavy and light rains (Rain_BounHeaLi), the average value of 'light' and 'heavy' rains (Rain_Light and Rain_Heavy) and a coefficient of variability for heavy rain (Rain_CoeffVar). Light rain is truncated from a normal distribution with 0.5 as

minimum and Rain_BoundHeaLi (default 25 mm) as maximum value, heavy rain is truncated with Rain_BoundHeaLi as minimum. The standard deviation for light rains is as a standard input at 5 mm (but can be modified inside the equation for Stella users).

Table 3.3 Three options for deriving daily rainfall values

Rain_AType	1 = Tabulated daily rainfall	2 = Random generator	3 = Variation around monthly total
Probability of rain on a given day	not applicable	Rain_DayP, split via Rain_HeavyP into 'light' (0.5-25) and 'heavy' (> 25 mm/day) rains	Rain_DayP
Amount of rain	Read from table	Normal distribution around Rain_Light and Rain_Heavy (truncated at zero)	Normal distribution around Rain_MonthTot / (Rain_DayP * 30) (truncated at zero)
Variability of rainfall	Implicit in data read from table	Rain_CoeffVar for heavy rain category, for light rain a standard deviation of 5 is used	Rain_CoeffVar

For choice 3, tabulated monthly averages are entered in 'Rain_MonthlyTot'. Daily rainfall is derived from a normal distribution around this average value, with a standard deviation defined as coefficient of variation.

$$Rain = \max(0, Rain_Today) * Normal\left(\frac{Rain_MonthTot}{30 * Rain_DayP}, \frac{Rain_CoeffVar * Rain_MonthTot}{30 * Rain_DayP}, Rainseed\right) \quad [6]$$

The 'Normal' function in Stella has three arguments: mean, standard deviation and seed. We protect against negative rainfall values for obvious reasons.

The linked data for option 1 and tabulated monthly data in option 3 may start at any 'day of year' before the simulation starts. They are read via Day of Year' variable $Rain_DOY = \text{Mod}(\text{Time} + Cq_DOYstart, 365)$. For option 1 one can start at any year of the climatic data set by specifying Cq_YearStart (one should be careful not to have the simulation start before or extend beyond the rainfall data set in such a case. It is possible to repeatedly use the rainfall data for a single year for a multiyear run (RainCycle? = 1), or to read multi-year data from the Excel spreadsheet run (RainCycle? = 0). One would normally start reading rainfall data at year 0; if one wants to start at a later point in the data set, the parameter Cq_YearStart has to be adjusted.

The Rain_DayP values are given as a monthly tabulated function of Day of year.

3.2.5 Canopy interception of rainfall

Part of any rainfall event will not reach the soil surface because the tree or crop canopy intercepts it. This interception process has been included on the basis of a maximum water storage capacity of the tree + crop canopy, calculated as a thickness of water film times the leaf area index (ignoring water stored on stem surfaces). Water will evaporate from this intercepted layer at a speed equal to the potential evapotranspiration rate, with priority over crop and tree transpiration or soil evaporation.

3.2.6 Soil redistribution on slopes

Soil particles can get detached during rainfall events, move along with surface runoff water and may get entrenched or filtered out where the waterflow slows down on a rough surface or encounters a zone of high net infiltration rates. Soil particles can also be moved by soil tillage (section 3.10.8), especially by ploughing. The amount of soil particles leaving the border of any measurement area is a balance of the amount entering it from above, plus the amount of soil starting to move within the area, minus the amount filtered. A process level description of such events should consider a time scale of minutes (or less) and deal with considerable heterogeneity in conditions at the soil surface. For WaNuLCAS we've chosen for a more aggregated description, in line with the daily time step, but maintain:

$$soil_outflow = (1 - filterefficiency) (soil_inflow + soil_stirredup) \quad [7]$$

where the filter efficiency is expressed as fraction of the soil moving. For a typical situation with contour hedgerows (or other vegetative filter strips), we can allocate most of the filter effect to 'Zone 1', while soil cover in all zones modifies the amount of soil stirred up.

A further simplification, although not strictly necessary for the model to function, is to assume that at any time the soil surface is approximately a plane within the zones considered. The main issues then are:

1. how does the soil slope change over time,
2. how much is the net outflow from one simulated land unit,
3. how are the properties of the topsoil modified in each zone due to the soil movement and filter effects.

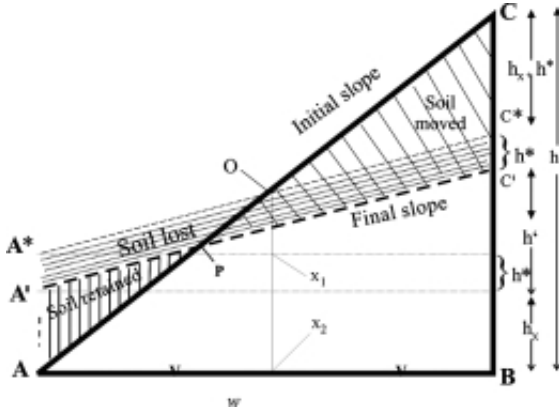

Figure 3.4. Terminology for describing change of slope: ignoring the soil below the boundary A-B which will not be affected by the changes and assuming that the bulk density of the soil is constant, the redistribution process modifies the triangle A-B-C (with a width w , a height h and a slope-length s) into the polygon A-A'-C'-B (with height h' and slope length s'), plus the soil loss which is proportional to AA^*C^* , or wh^* ; the triangle AA^*O is equal to OCC^*

Change of slope

We want to derive the terrace height h_x and the final slope (h'/w) from the initial_slope (h/w), the amount of soil moved and the amount lost. We first assume that the position of point A is fixed and that soil accumulation (terrace formation) can increase the level to point A' but not decrease the level. From Fig. 3.4 we can see that:

$$h = 2(h_x + h^*) + h' \quad [8]$$

$$\text{Soil_lost}/(\text{bulkdens } b) = ABC - AA'C'B = A'A^*C^*C' = h^*w \quad [9]$$

$$\begin{aligned} \text{Soil retained}/(\text{bulkdens } b) &= (\text{Soil_moved} - \text{Soil_lost})/(\text{bulkdens } b) = AA'P = (h_x/(h_x + h^*))AA^*O = \\ &= (h_x/(h_x + h^*)) (AA^*X_1X_2 + A^*OX_1 - AOX_2) = (h_x/(h_x + h^*)) ((h-h')w/4 + h'w/8 - hw/8) = \\ &= (h_x/(h_x + h^*))w(h-h')/8 = wh_x/4 \end{aligned} \quad [10]$$

Hence,

$$\text{Terrace_height} = h_x = 4(\text{Soil_moved} - \text{Soil_lost})/(\text{bulkdens } b w) \quad [11]$$

If $\text{Soil_lost} = \text{Soil_moved}$ and thus $\text{Soil_retained} = 0$, this leads to $h_x = 0$.

Combining [8], [9], [10] and [11] we obtain:

$$\text{Final_slope} = \text{Initial_slope} - (8\text{Soil_moved} - 6\text{Soil_lost})/(\text{Bulkdens } b w^2) \quad [12]$$

If Soil_moved and Soil_lost are expressed in Mg, w in m, the model is applied to a breadth b of 1 m and bulkdensity in Mg m^{-3} , the final slope is indeed dimensionless.

For the time being the effect of soil movement on the soil quality of the receiving zones (soil C, N and P contents, soil physical properties) are ignored, i.e. we assume the incoming soil to have the same properties as the average of the receiving zone. This may cause inconsistencies in the total C, N and P balance and will need further attention in a future release.

The situation where point A is not fixed, can lead (in the absence of filter functions) to a parallel decline of topsoil height, without change in slope angle.

3.2.7 Soil erosion

Soil erosion module applies to sloping land situation only. WaNuLCAS uses ROSE (physical equation) equations to estimate soil erosion. Tillage will affect soil erosion (see 3.10.8)

3.3 Water balance

3.3.1 Soil water storage, infiltration and evaporation

For the description of the soil water balance in soil-plant models a number of processes should be combined which act on different time scales (Figure 3.5):

1. rainfall or irrigation (with additional run-on) and its allocation to infiltration and surface run-off (and/or ponding), on a seconds-to-minutes time scale,
2. infiltration into and drainage from the soil via a cascade of soil layers, and/or via 'bypass' flow, on a minutes-to-hours time scale,
3. subsequent drainage and gradual approach to hydrostatic equilibrium on a hour-to-days time scale,
4. transfers of solutes between soil layers with mass flow,
5. evaporation from surface soil layers on a hour-to-day time scale,
6. water uptake on a hour-to-days time scale, but mostly during daytime when stomata are open,
7. hydrostatic equilibration via root systems on a hour-to-days time scale, but mostly at night when plant transpiration is negligible,
8. hormonal controls ('drought signals') of transpiration on a hour-to-weeks time scale,
9. changes in macropore volume (and connectivity) based on swelling and shrinking of soils closing and opening cracks, and on creation and destruction of macropores by soil macrofauna and roots; this acts on a

day-to-weeks time scale. Its main effect will be on bypass flow of water and retardation of nutrient leaching.

The WaNuLCAS model currently incorporates point 1...7 and 9 of this list, but aggregates them to a daily time step; drainage to lower layers is effectuated on the same day as a rainfall event occurred. An empirical infiltration fraction (as a function of rainfall intensity, slope and soil water deficit) can be implemented at patch scale. Between the zones of the WaNuLCAS model, surface run-off and run-on resulting in redistribution among zones can be simulated on the basis of a user-specified weighing function for effective rainfall in the various zones.

Upon infiltration a 'tipping bucket' model is followed for wetting subsequent layers of soil, filling a cascade of soil layers up till their effective 'field capacity'. Field capacity is estimated from the water retention curve (see section SOIL above).

Soil evaporation depends on ground cover (based on LAI of trees and crops) and soil water content of the topsoil; soil evaporation now stops when the top soil layer reaches a water potential of -16 000 cm.

A simple representation of by-pass flow is added, but only in its effects on nutrient leaching (see 3.4.3). Dynamics of macropore are described in section 3.3.7.

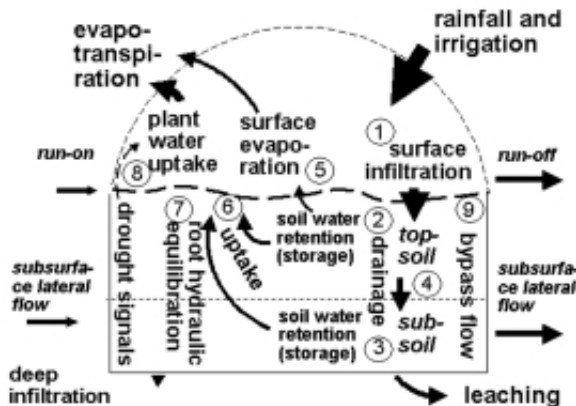

Figure 3.5. Elements of the water balance included in the WaNuLCAS model: 1. surface infiltration of rainfall, 2-4. Redistribution of water and solutes over the profile, recharging soil water content (2) and draining (leaching) excess water from the bottom of the profile, 5. surface evaporation, 6. water uptake by tree and crop roots, 7. hydraulic equilibration via tree roots, 8. drought signals influencing shoot:root allocation and 9. bypass flow of solutes.

Table 3.4 Water balance at patch level in WaNuLCAS

In	Out
Initial soil water content for all zones and layers	Final soil water content for all zones and layers
Patch-level run on	Patch-level run-off
Lateral inflow	Drainage from bottom of soil profile and lateral outflow
Rainfall	Soil evaporation
Irrigation (added as extra rainfall)	Evaporation of intercepted water
	Transpiration by tree
	Transpiration by crop
	Transpiration by weed

3.3.2 Water uptake

Water uptake by the plants is driven by their transpirational demand, within the possibilities determined by roots length density and soil water content in the various cells to which a plant has access.

The calculation procedure used by De Willigen and Van Noordwijk (1987, 1991) is based on an iterative procedure, solving the simultaneous equations for soil + plant resistance as a function of flow rate, and of flow rate as a function of the resistance's involved. As this routine can not be implemented as such in a Stella environment, we chose for an approximate procedure, where some of the feed-back is included on an a-priori basis, and an other part is implemented in the next time step, by keeping track of the plant water status inherited from the previous day,

Plant water potential is calculated on the basis of soil water potential (weighted average over all zones and layers on the basis of local root length density, minus the potential to overcome root entry resistance if full transpirational demand is to be met, and a term to cater for expected soil resistance (estimated as 10% of soil water potential; a more precise value is calculated in step 5 of the daily procedure - see below)).

The sequence of events in modeling water uptake (Fig. 3.6):

1. Estimate potential transpirational demand E_p from potential dry matter production (an input to WaNuLCAS, derived from other models), diminished to account for the current shading and LAI, multiplied with a water use efficiency (CW_TranspRatio, again a model input, reflecting climate and crop type),

2. Estimate plant water potential on the basis of the various resistances in the catenary process:
 - (a) soil water potential as perceived by the plant (weighted average over all zones and layers on the basis of local root length density),
 - (b) a term to cater for expected resistance between bulk soil in the voxel and the root surfaces (in the default situation initially estimated as 5% of soil water potential; a more precise value is calculated in step 5 of the daily procedure - see below)
 - (c) the potential gradient needed to overcome root entry resistance if full transpirational demand is to be met
 - (d) the potential gradient needed to overcome root axial transport resistance if full transpirational demand is to be met.
3. On the basis of this plant water potential, calculate the transpiration reduction factor f_p on the basis of a function proposed by Campbell (De Willigen *et al.*, 2000),
4. Use the reduced uptake demand $f_p E_p$ to estimate the rhizosphere potential h_{rh} for all voxels i from the plant potential h_p minus the potential gradient needed to overcome the axial transport distance given the length of the pathway from voxel to stem base (Radersma and Ong, 2004),
5. Calculate potential water uptake rates for all layers i on the basis of $h_{s,i}$ and h_{rh} and their equivalent matric flux potentials F ; the matrix flux potential is the integral over the unsaturated hydraulic conductivity and can be used to predict the maximum flow rates which can be maintained through a soil (De Willigen and Van Noordwijk, 1994), taking into account that the drier the soil the more difficult it is to move water through a reduced water-filled pore space

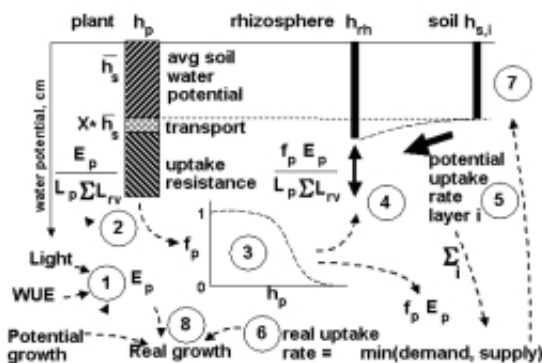

Figure 3.6. Steps (1...8) in daily cycle of calculations of water uptake; the interrupted arrows represent information flows

6. Calculate real uptake as the minimum of demand ($f_p \cdot E_p$) and total supply (summed over all layers i) and allocate it to layers on the basis of potential uptake rates,
7. Recalculate soil water contents in all layers i for the next time step.
8. Calculate a 'water stress factor' from real uptake as fraction of potential transpirational demand; real growth is based on the minimum of the 'water stress' and 'nutrient stress' factor and potential growth.

The procedure for water uptake is similar to that for nutrient uptake (see below), but the transport equations are analogous in terms of 'matric flux potential' rather than soil water content. A further complication for allocating water uptake is that plant water potential may differ between roots of the various components in a given cell. In the model the highest (least negative) is used first to share out potential water uptake to all components, followed by additional uptake potential for components with a lower water potential (Figure 3.7).

The model in its current form does not include 'drought signals'. It may be possible to represent such direct effects of root-produced hormones on stomatal closure by adding a relation between $CW_PotSoil$ (the averaged water potential around the roots of a crop) and the $CW_DemandRedFac$, beyond their current indirect relation via $CW_PotSuctCurr$.

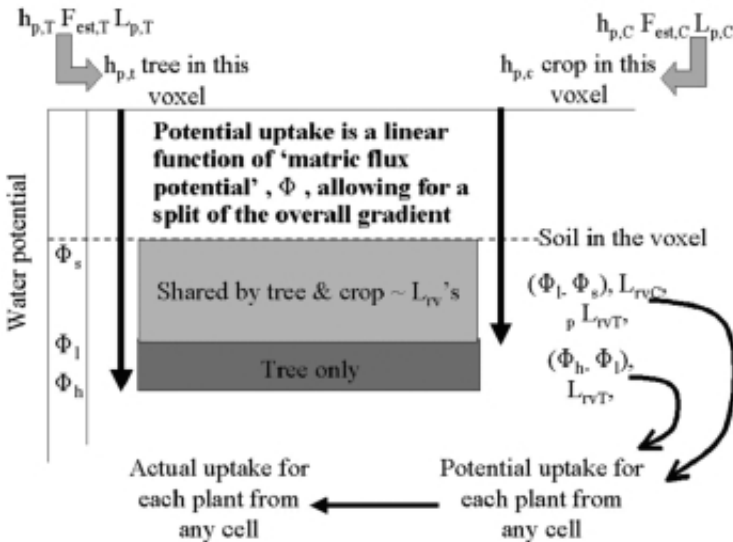

Figure 3.7. Diagram of sharing out available water by tree and crop

3.3.3 Hydraulic lift and sink

An option exist to simulate hydraulic lift and hydraulic sink phenomena in tree roots, transferring water from relatively wet to relatively dry layers. The parameter $W_Hyd?$ determines whether or not this is included (0 = not, 1 = yes). Hydraulic continuity via root systems can lead to transfers of water between soil layers, on the basis of water potential and resistance. If the subsoil is wet and the surface layers are dry, this process is called hydraulic lift (Dawson, 1993). The reverse process, transfers from wet surface layers to dry subsoil is possible as well and has recently been observed in Machakos (Kenya) (Smith *et al.*, 1998; Burgess *et al.*, 1998). Although the total quantities involved in these water transfers may be relatively small, it can be important in the competition between shallow and deep-rooted plants. Hydraulic lift can re-wet nutrient-rich dry topsoil layers and thus facilitate nutrient uptake. The reverse process, deep water storage by deep rooted plants after moderate rainfall which only infiltrate into the topsoil, can increase their overall resource capture vis-a-vis shallow rooted plants.

A general solution for the flux F_i into or out of each cell i is:

$$F_i = \frac{\sum_{j=i}^n (\psi_i - \psi_j)}{\sum_{j=1}^n r_j r_j} \quad [13]$$

where i and j refer to the root water potential in layer i and j , respectively and r_i and r_j to the resistance to water flow between the soil layer and stem base. This equation assumes a zero transpiration flux at night.

3.3.4 Implementing a lateral flow component into WaNuLCAS

Earlier versions of the model only considered vertical flow, but evidence from the field experiments in Lampung indicates that even on very mild slopes (4%) a lateral flow component is important (Suprayogo, 2000).

As the model operates at a daily time step, we can not give a detailed account of equilibration and some simplifying assumptions are required:

- lateral flow is only supposed to occur when incoming water exceeds the 'field capacity' for a given cell in the model; during the lateral flow as well as vertical drainage we assume the soil to operate at saturated hydraulic conductivity,
- the amount of water leaving a cell in the model, either vertically or horizontally, is equal to the amount of water coming in from above

(infiltrating rain in layer 1 and drainage from the layer above in other layers) + lateral inflow from the up-hill neighbouring cell - the amount of water it takes to recharge the profile to field capacity

- the amount of water flowing across any vertical or horizontal surface is the minimum of three quantities:
 1. the amount available for flow (as defined above),
 2. the amount that can cross the surface in a day, which depends on saturated hydraulic conductivity per unit area, the size of the surface area to be crossed, and the gradient (1 in the vertical direction, slope%/100 for the lateral flow), and
 3. the maximum storage in, plus outflow out of the column below the cell (this is to avoid 'back logging' of water in a dynamic sense; the outflow in a lateral direction is ignored as it will normally be matched by incoming lateral flows)
- the allocation of total drainage out of a cell over vertical and lateral outflow is based on the relative maximum outflows, but lateral flow can be greater than its nominal share if another constraint on vertical flow so allows; if there is (still) excess water coming into a cell (as lateral inflow exceeds lateral outflow), it is allocated to the water stock in the cell, which can thus be above field capacity (the next day this will be reflected in a negative value of the potential recharge),
- lateral flow normally has no influence on the soil water content after the rain event (as the soil will return to field capacity everywhere), but it can have a major impact on the redistribution of nutrients.

Implementing sub-surface lateral flow required the following steps:

1. Splitting the excess (incoming - recharge) water for each timestep into a vertical and a horizontal flow component (W1)

The amount of water leaving a cell is apportioned over one horizontal flow (to the left-hand neighbour) and one vertical one (to the lower neighbour), on the basis of saturated hydraulic conductivity, gradient in hydraulic head (difference in height of neighbouring cells divided by their distance) and surface area through which the flow occurs:

$$Flux_{ij} = \frac{Ksath_{ij} HydHeadHor_{ij} ((depth_i - depth_{i-1})^2)}{Ksatv_{i4} * zonenw_i + Ksath_{ij} HydHeadHor_{ij} ((depth_i - depth_{i-1})^2)} \quad [14]$$

$$Flux_{vi} = \frac{Ksatv_{i4} * zonenw_i}{Ksatv_{i4} * zonenw_i + \sum_i Ksath_{ij} HydHeadHor_{ij} ((depth_i - depth_{i-1})^2)} \quad [15]$$

with:

$$HydHeadHor_{i1} = (depth_{i,1} - depth_{i-1,1})(zonew_i + zonew_{i-1}) + origslope \quad [16]$$

and for $j > 1$ $HydHeadHor_{ij} = origslope$

2. Accounting for incoming water from above (rainfall in layer 1, vertical drainage from the layer above for the other zones), as well as laterally (W2)

A 'circularity' problem arose when we tried to calculate the lateral flow out of zone 4 as input to zone 3 in the same soil layer. As a first approximation we made the assumption that the incoming lateral flow will not have an impact on the subsequent soil water content in a layer (which will return to field capacity if incoming rainfall is sufficient). This first estimate allows us to calculate an estimated drain volume from each cell, which is correct only for zone 4. In a next step, corrections are applied for zone 3, zone 2 and zone 1 in sequence, based on the knowledge of the real incoming lateral flows

3. Defining incoming lateral flow to the simulated zones for all layers (W3)

We assume that the soil up-hill (beyond zone 4) of the simulated zones has similar properties to the soil in the 4 zones: it is assigned the average split over vertical and horizontal drainage found in the simulated zones (see W1), and the same rainfall per unit area. The total amount of water coming in is further set by the width of the area generating lateral flow, relative to the total width of the zones considered.

4. Calculating lateral flows of nutrients by multiplying amounts of water moving with the average concentration in soil solution, with an option for 'by-pass flow' of water without exchange with the soil matrix (N1)

The equations followed the same logic as those for vertical leaching, but an option was provided that bypass flow may differ between nutrients already in the N stock of a cell ('matrix') and those in the current in-flow ('macropore'; this includes the fertilizer just added to the soil - if the first rain is mild it will get absorbed by the soil, if the first rainy day is a heavy rain, it may leach down or out quickly depending on the value used for the two by-pass flow parameters).

5. N2 - Defining the incoming nutrient concentrations for the incoming subsurface flow.

The incoming nutrient concentrations for the incoming subsurface flow can be defined as a multiplier of the average concentration of drainage water within the simulated zones.

3.3.5 Run-on and Run-off

Surface run-on and run-off are treated in a similar way, but here the conductivity is supposed to be non-limiting as soon as the slope exceeds 0. A RunonFrac parameter determines which fraction of the run-off generated uphill will actually enter the plot. The current routine replaces the old one where the run-off fraction was directly defined from the rainfall amount. In the new version a variable run-off fraction can be simulated, depending on the water content of the soil profile. Essentially two situations can lead to surface run-off:

- daily rainfall plus run-on exceed daily maximum infiltration rate (by setting these values one may try to compensate for typical rain duration per day),
- daily rainfall plus run-on exceed the potential water storage in and outflow from the soil column underneath the surface.

The first type of run-off is typically determined by properties of the soil surface (such as crusting and hydro-phobic properties) and the current infiltration capacity of the soil in the time available for infiltration. The time available for infiltration depends on the duration of the rainfall, the delayed delivery of rainfall to the soil via canopy interception and dripping of leaves (+ stemflow), and the rate at which water ponding on the surface will actually flow to a neighbouring zone or plot. The latter depends on slope. Formally:

$$Rain_TimeAvForInf = \text{Min}(24, Rain_Duration + Rain_IntercDelay + Rain_SurfPondDelay) \quad [17]$$

with

$$Rain_Duration = \left\langle \frac{Rain}{Rain_IntensMean} \right\rangle * \text{Min}(\text{Max}(0, 1 - 3 * Rain_IntensCoefVar, \text{Normal}(1, Rain_IntensCoefVar, Rain_GenSeed + 11250))) + 3 * Rain_IntensCoefVar \quad [18]$$

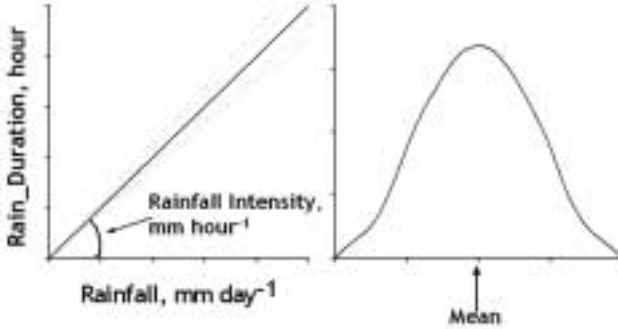

Figure 3.8. Rain Duration that determine the time available for water infiltrated to the soil. Rain duration calculated from Rainfall and Rain Intensity.

$$Rain_IntercDelay = \text{Min} \left(Rain_Max_IntDripDur, Rain_IntMult * \frac{Rain_Interception}{Rain_IntercDripRt} \right) \quad [19]$$

where the factor IntercMultiplier indicates the maximum temporary storage of water on interception surfaces divided by the amount left at the end of the dripping stage, and the Drip_Rate is expressed in mm hr⁻¹. Default assumptions are Rain_IntMult = 3, Rain_IntercDripRt = 10 mm hr⁻¹, Rain_Max_IntDripDur = 0.5 hr.

and

$$Rain_SurfPondDelay = \frac{Rain_PondStoreCp * Rain_PondFlwRt * AF_ZoneWidth}{AF_SlopeCurr} \quad [20]$$

with default Rain_PondStoreCp = 5 mm, and Rain_FlwRt = 10 mm hr⁻¹ per m of AF_ZoneWidth

The second type of run off is by the depth of the profile and the saturated hydraulic conductivity of the deep subsoil.

Intermediate situations with sub-surface run-off may build up from 'top down' (higher layers before deeper ones), or 'bottom up' (starting from the subsoil), depending on the specific profile in saturated hydraulic conductivities.

3.3.6 Subsurface inflows of water to plots on a sloping land

In WaNuLCAS 3.01 subsurface in-flows are derived from a 'virtual' soil column uphill (Fig 3.9). This process is only functioning during rainfall events, especially ones that saturate the soil and cause overland or subsurface lateral flow. These are the times, however, that the soil in the 4 zones is in

similar 'overflow' mode. An important additional type of lateral inflow may occur during dry periods, when part of the horizontal groundwater flows may come within reach of the roots in the simulated zones. A simple representation of such flows makes use of a 'stock' of groundwater stored uphill, that depends on the 'number of plots uphill' as a scaling factor and the vertical drainage calculated (Fig. 3.10).

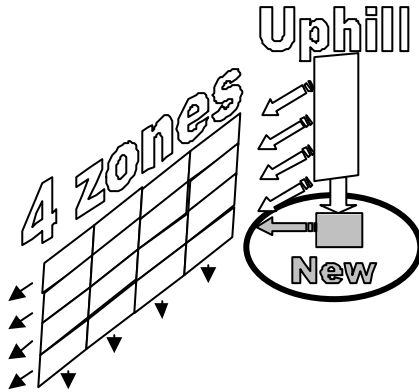

Figure 3.9 General lay out of soil column uphill in WaNuLCAS model

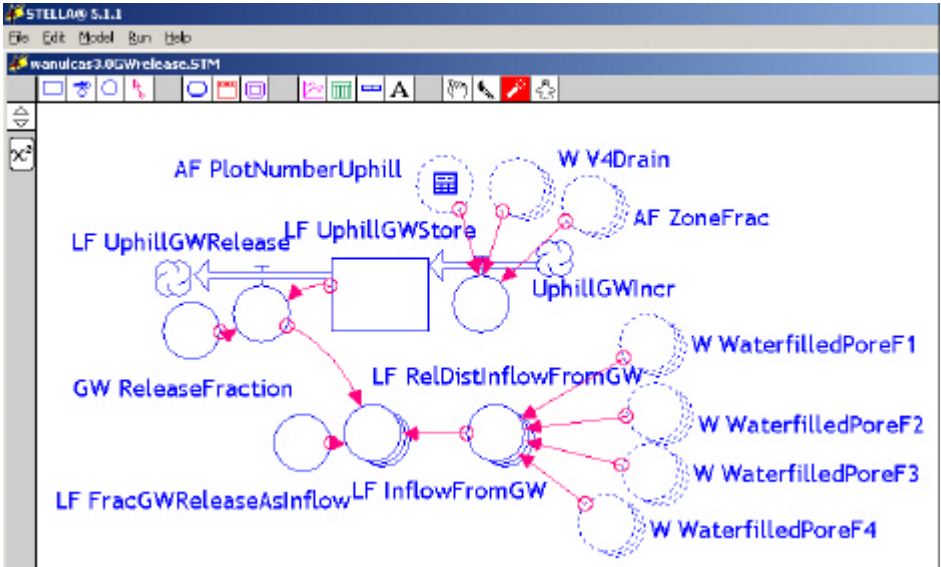

Figure 3.10 show module of subsurface in-flows from uphill plot in WaNuLCAS

3.3.7 Dynamics of macropore formation and decay

Formation and decay of macropores has consequences for the bulk density of the 'soil matrix', as the mass balance of soil solids has to be conserved. Compaction of the 'matrix' may increase the unsaturated hydraulic conductivity of the soil, while the macropores themselves greatly increase the saturated conductivity. If 'pedotransfer' functions are used, the change in bulk density (and possibly soil organic matter content) at constant texture can lead to predicted changes in water retention and the unsaturated hydraulic conductivity in a simple way, once the dynamics of macropores are predicted. Where macropores are dominated by cracking, a description of the swelling and shrinking properties is needed as function of soil water content. Where macropores are dominated by roots, earthworms and/or other soil macrofauna their population density and activity should be known, as well as the fraction of macropores temporarily blocked by roots and the rates at which macropores are back-filled by internal slaking of soils and/or bioperturbation.

In WaNuLCAS 3.01 the option is provided for a dynamic simulation of macropore structure. In the Wanulcas.xls spreadsheet, the user can define an initial saturated hydraulic conductivity value that differs (exceeds or is lower than) from the default value predicted by the pedotransfer value. The pedotransfer value reflects a surface infiltration rate in absence of soil biological activities. During the simulation the value will tend to return to this default value, at a rate determined by the S_BDBDRefDecay parameter. The pedotransfer value is used as default, as it reflects measurements in small ring samples without much effect of soil structure. Depending on the 'foodforworms' provided by the structural and metabolic organic inputs (with conversions set by the parameters S_WormsLikeLitStruc, S_WormsLikeSOMStruc, S_WormsLikeLitMetab and S_WormsLikeSOMMetab, respectively), and the relative depth impact of the worms on the given location (the S_RelWormdepth parameters determine the relative impact for each soil layer and S_RelWormSurf the impact on surface infiltration), earthworms can increase saturated conductivity above the default value, but this structure will gradually decay if not actively maintained. With root type 2 during the simulation, an amount of root decay allocated for 'root channels' by calculated root decay on a root biomass basis converted to root volume, and multiplied by an estimate of the fraction of roots that had formed new channels (as opposed to following existing channels, macropores or growing over aggregate surfaces) with conversions set by the parameters S_T_RootFormStrucFrac and S_C_RootFormStrucFrac for tree and crop root respectively.

With the current structures in place the model is sensitive to variations in saturated hydraulic conductivities (at least in certain parameter ranges, depending on rainfall regime and soil water storage parameters). It may be relatively easy now to make the saturated hydraulic conductivity a dynamic property, e.g. inheriting a system of old tree root channels from a preceding forest phase, with an exponential decay of such channels and a rate of new formation by (tree) root turnover and/or earthworm activity within the layers. Impacts of soil biota on macro-structure of the soil can now be explored.

3.4 Nutrient (nitrogen and phosphorus) balance

3.4.1 Nutrient inputs and outputs

WaNuLCAS release 1.1 only included a nitrogen balance. From release 1.2 onwards, an array 'nutrients' is used with nitrogen as first and phosphorus as second array element. The equations originally developed for nitrogen could be applied to the broader class nutrient, with a number of exceptions which will be noted in the text. In the model, interactions between N and P are only indirect, based on the interaction of both nutrients with plant dry matter production and/or soil organic matter transformations.

Nutrient inputs to each cell can be based on leaching from higher layers (water flux multiplied with current concentration in soil solution, assuming no by-pass flow of water to occur). At the bottom of the soil profile nutrient losses by leaching become non-recoverable. For the top layer, inputs can consist of mineral fertilizer at specified times and rates, and from the mineralization of organic matter (on the basis of a process description similar to the Century model; Parton *et al.*, 1994). Total organic inputs are allocated to the various zones on the basis of user-specified weighing functions.

Table 3.5 Nutrient (nitrogen and phosphorus) balance at patch level

In	Out
Initial inorganic N or P stock in soil	Final inorganic N or P stock in soil
Initial organic N or P in SOM-pools	Final organic N or P in SOM-pools
N & P in lateral inflow	N & P in lateral outflow
Fertilizer N or P input	N or P leached from bottom of soil profile
N or P in external inputs or organic material	N or P in harvested crop yield
Atmospheric N fixation (only for N)	N or P in harvested tree components
N or P in crop planting material	Final N or P in crop biomass
Initial N or P in tree biomass	Final N or P in tree biomass

3.4.2 Nutrient inputs

Nutrient (nitrogen or phosphorus) inputs consist of initial amounts in mineral and organic N pools in the soil, initial stocks in the tree and crop seeds, and inputs during the simulation from fertilizer, organic inputs from outside and internal recycling of crop residues and tree litter fall and pruning.

For fertilizer inputs setting the parameters `Ca_FertAppYear`, `Ca_FertAppDOY`, `Ca_FertAppRate[Nutrient]` can specify the dates and amounts. It is also possible to have two types of organic input as part of management during simulation, `Ca_ExtOrgInp`. This would need additional parameters to define the lignin, polyphenol, N and P content.

3.4.3 Leaching

Leaching of N (and P) is driven by percolation of water through the soil and the average concentration in soil solution. The latter is derived from the inorganic nutrient stock, the soil water content and the apparent adsorption constant.

An option is provided for flow of water through macropores (e.g. earthworm or old tree root channels), bypassing the soil solution contained in the soil matrix. A multiplier `N_BypassMacroI[Zone]` is used in the leaching equation, which can get different values for each zone and or layer, e.g. to study the effect of earthworm activity mainly in the top layer of zone 1. Default value for `N_BypassMacroI [Zone]` is 1, values less than 1 lead to bypass flow (retardation of nutrient leaching), values above 1 to preferential flow (e.g. possible with rainfall directly after fertilization).

3.4.4 Nutrient (N or P) uptake

The nutrient uptake procedure includes 8 steps (the numbers refer to Fig. 3.11)

1) Target nutrient content. The general flow of events starts with the current biomass (dry weight). First of all a 'target N content' is calculated from a generalized equation relating N uptake and dry matter production under unconstrained uptake conditions (De Willigen and Van Noordwijk, 1987; Van Noordwijk and Van der Geijn, 1996). The default equation used assumes a 5% and 0.5% (or `Cq_NconcYoung[Nutrient]`) N and P target in the young plant, up to a biomass of 0.2 kg m^{-2} ($= 2 \text{ Mg ha}^{-1}$) (or `Cq_ClosedCanopy`) which may coincide with the closing of the crop canopy, and a subsequent dilution of N in the plant, resulting in

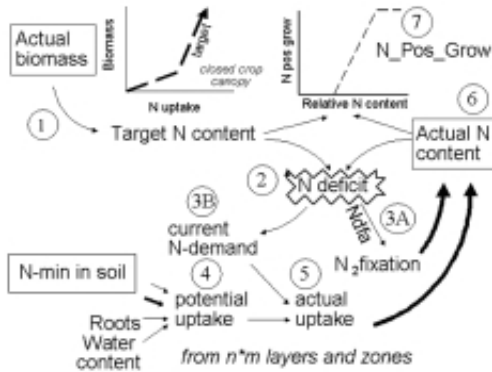

Figure 3.11 Major steps (explained in the text) in the daily cycle of calculating N uptake; a similar scheme applies to P uptake (without N₂ fixation, but with additional options for 'rhizosphere effects')

additional N uptake at a concentration of 1% and 0.1% ($Cq_NConcOld[nutrient]$). The parameters in this equation can be modified for specific crops. Similarly, for the tree a nutrient target is derived by multiplying the biomass in leaves, twigs, wood and root fractions with a target N or P concentration ($T_NlfConc[nutrient]$, $T_NTwigConc[nutrient]$, $T_NWoodConc[nutrient]$, $T_NRtConc[nutrient]$, respectively).

2.3) Nutrient deficit. The target N content is then contrasted with the current nutrient content, to derive the 'Nutrient deficit'. The N deficit can be met either by atmospheric N fixation, governed by a fraction of the deficit on a given day (3a).

$$CN_Demand = CN_Deficit * (1 - 0.5 * Cq_Stage)^2 \quad [21]$$

The fraction is a user-defined value NDFA (if N supply from the soil is limiting the final percentage of N derived from fixation may be higher than the NDFA parameter chosen - some calibration may be needed to get realistic settings). The N-deficit not met by N fixation as well as the P-deficit lead to Nutrient demand (3b) for uptake from the soil. To avoid too drastic recoveries of uptake where nutrient supply increases after a 'hunger' period, not all of the nutrient deficit can be met within one day:

The fraction of the N deficit covered by the demand decreases with the physiological age of the crop; at flowering ($Cq_stage = 1$) only 25% of a deficit can be made up within one day and at full maturity ($Cq_stage = 2$) the uptake response has stopped. The parameters 0.5 and 2 used here have no solid empirical basis, but there is sufficient evidence to suggest that the responsiveness of uptake to past deficits does decrease with plant development.

4) Potential uptake. Potential nutrient uptake U_{ijk} from each cell ij by each component k is calculated from a general equation for zero-sink uptake (De Willigen and Van Noordwijk, 1994) on the basis of the total root length in that cell, and allocated to each component proportional to its effective root length:

$$U_{ijk} = \frac{Lrv_{ijk} \pi D_0 (a_1 \Theta_{ij} + a_0) \Theta_{ij} H_{ij} N_{stock,ij}}{\sum_k Lrv_{ijk} (K_a + \Theta_{ij}) \left[-\frac{3}{8} + \frac{1}{2} \ln \frac{1}{R_0 \sqrt{\pi \sum_k Lrv_{ijk}}} \right]} \quad [22]$$

where Lrv is root length density (cm cm^{-3}), D_0 is the diffusion constant for the nutrient in water, Θ is the volumetric soil water content, a_1 and a_0 are parameters relating effective diffusion constant to θ , H is the depth of the soil layer, N_{stock} is the current amount of mineral N per volume of soil, K_a is the apparent adsorption constant and R_0 is the root radius.

For P the same equation applies, but the apparent adsorption constant (the ratio of the desorbable pool and P concentration in soil solution) is not constant but depends on the concentration; parameters for a range of soils are included in the parameter spreadsheet,

5) Actual uptake. Actual uptake S_{ijk} is derived after summing all potential uptake rates for component k for all cells ij in which it has roots. Total uptake will not exceed plant demand. The effects of crop N and P content on dry matter production are effectuated via $N_pos_grow[\text{nutrient}]$.

$$S_{ijk} = U_{ijk} \frac{\min \left(demand_k, \sum_1 \sum_j U_{ijk} \right)}{\sum_i \sum_j U_{ijk}} \quad [23]$$

6&7) N_Pos_Grow[Nutrient]. Actual uptake and N_2 fixation are both added to the actual N content (6) to complete the process for this timestep. Actual N content of the plant has a feedback on plant growth via $N_PosGrow$ (7). The N_Pos_Grow parameter varies between 0 and 1. The actual N content can stay 20% behind on the N target before negative effects on dry matter production will occur (the N target thus includes 25% 'luxury consumption'); dry matter production will stop when the N content is only 40% of the N target; between 40 and 80% of the N target a linear function is assumed. The same function is used for tree and crop N_Pos_Grow .

3.4.5 Effective adsorption constants for ammonium and nitrate

Two forms of mineral N occur in most soils, ammonium and nitrate, which differ in effective adsorption to the soil and hence in leaching rate and movement to roots. Microbial transformation of ammonium to nitrate ('nitrification') depends on pH, and relatively slow nitrification may reduce N leaching from acid soils. Plant species differ in their relative preference for ammonium relative to nitrate in uptake, with only specialized plants able to survive on a pure ammonium supply; in the current model version such effects are ignored and it is assumed that the 'zero sink' solution for nitrate plus ammonium adequately describes the potential N uptake rate for both crop and tree. In the WaNuLCAS model a single pool of mineral N is simulated, but it can cover both forms if a weighted average adsorption constant is used. The potential uptake is inversely proportional to $(K_a + W_{theta})$, while the leaching rate is inversely proportional to $(K_a + 1)$. Both potential uptake and leaching are directly proportional to the N_{stock} , so the sum over nitrate and ammonium forms of mineral N can be obtained by adding N_{FracNO_3} times the term with K_a for nitrate plus $(1 - N_{FracNO_3})$ times the K_a for ammonium, where N_{FracNO_3} is the fraction of mineral N in nitrate form.

An 'effective' apparent adsorption constant K_a for a nitrate + ammonium mixture can be calculated as:

$$N_K_{a_{eff}} = -X + \frac{(N_K_{aNO_3} + X)(N_K_{aNH_4} + X)}{N_K_{aNO_3} + N_FracNO_3(N_K_{aNH_4} - N_K_{aNO_3}) + X} \quad [24]$$

where X equals 1 for the leaching equation and W_{theta} for the uptake equation.

In the current version of the model $N_K_{aNO_3}$ and $N_K_{aNH_4}$ are user-defined inputs; in future they may be calculated from clay content and soil pH. The parameter N_{FracNO_3} is also treated as a user-defined constant for each soil layer; in future it may be linked to a further description of nitrification and be affected by the N form in incoming leachates in each layer and selective plant uptake.

3.4.6 P sorption

In the model the sorbed + soil solution P is treated as a single pool (Fig. 3.12A), but at any time the concentration in soil solution can be calculated on

the basis of the current apparent absorption constant K_a ; this way effects on K_a can be implemented separate from effects on total labile pool size.

For P the apparent sorption constant K_a is a function of the amount of mobile P in the soil. In the WaNuLCAS.xls spreadsheet examples of P sorption isotherms are given for Indonesian upland soils (Fig. 3.12B) and Dutch soil types. The spreadsheet also gives a tentative interpretation to soil test data, such as P_Bray, and translates them into total amounts of mobile P, depending on the sorption characteristics of the soil. This part of the model, however, is still rather speculative. It is based on the assumption that during a soil extraction (e.g. P_Bray2 or P_water) the effect of the extractant on sorption affinity and the soil:solution ratio determine the amount of P extracted from the soil, while non-labile pools do not interact with the measurements. Following this assumption, the relation between a soil test value such as P_Bray2 and the size of the labile pool does depend on the sorption characteristics of the soil.

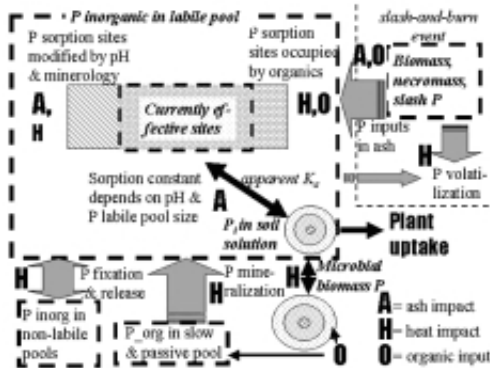

A

Figure 3.12 A. Conceptual scheme of P pools in the soil as represented in the WaNuLCAS model and potential impacts of ash (A), heat (H) or addition of organics (O); B Example of relations between apparent P sorption and total amount of mobile P in a soil, using data from the database of P sorption isotherms for acid upland soils in Indonesia (names refer to the location, in the absence of more functional pedotransfer functions for these properties...)

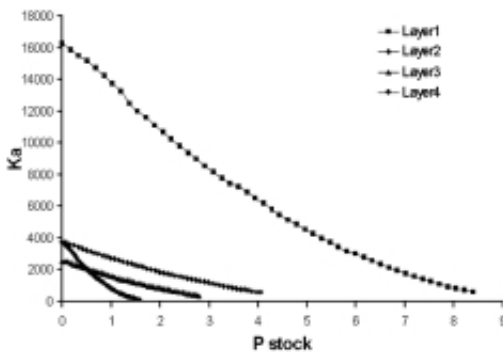

B

3.4.7 N₂ fixation from the atmosphere

The option exists for both crops and trees to represent atmospheric N₂ fixation as way of meeting the plant N requirement. The resultant fraction of N derived from the atmosphere (C_Ndfa or T_Ndfa) can be obtained as model output and equals $N_{fix}/(N_{fix} + N_{uptake})$.

N₂ fixation is calculated as a fraction of the current N deficit on any day. If the parameters C_NfixVariable? or T_NfixVariable? are set to 0 (= false), this fraction simply equals the C_NfixDailyFrac or T_NfixDailyFrac parameters set as model input and does not depend on N status of the plant, nor does N fixation have implications for the energy (C) balance of the plant. The part of the N deficit not covered by N₂ fixation drives the demand for uptake from the soil. If one wants to obtain a certain overall NDFA result, the NfixDailyFrac parameter has to be set at a lower (approximately half) value, depending on N supply from the soil, as parts of the deficit not met by uptake from soil on a given day will be included in the calculation for N₂ fixation on the next day (in the extreme case of no N uptake possibilities from the soil the overall NDFA will be 1 regardless of the . NfixDailyFrac parameter setting, as long as this is > 0).

If the parameters C_NfixVariable? or T_NfixVariable? are set to 1 (= true) (Fig. 3.13), the fraction of the N deficit covered by N₂ fixation on any day does depend on the N status of the plant and can be constrained by the

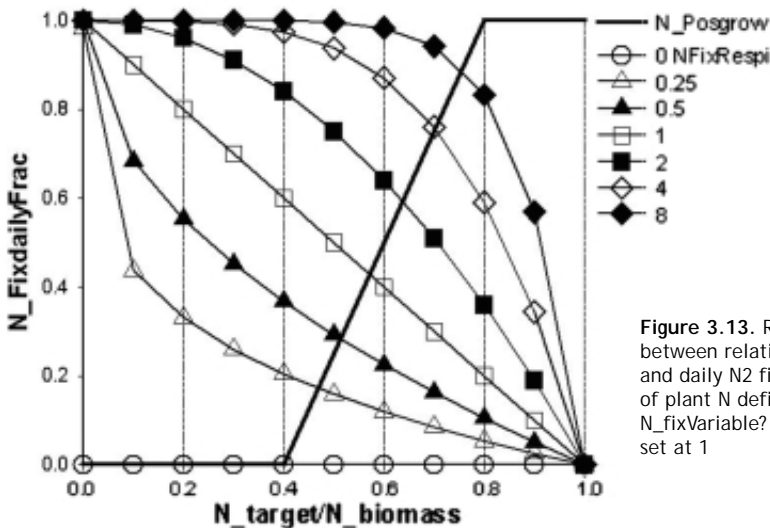

Figure 3.13. Relation between relative N content and daily N₂ fixation as part of plant N deficit, if the N_fixVariable? parameter is set at 1

energy (C) balance of the plant via the 'growth reserves' pool (this may implicitly lead to effects of water stress on N₂ fixation). These parameter settings, however, are still in an experimental stage.

If the parameters C_NfixVariable? or T_NfixVariable? are set to 1, N₂ fixation will use resources from the GroRes pools and can be constrained by the availability of these resources in the plant. A conversion factor (DWcost for Nfix) is used to reflect the respiration costs associated with N₂ fixation (roughly 0.01 kg DW per g N), and a maximum fraction of the GroRes pool to be used for N₂ fixation (MaxDWUsefor Nfix) is specified.

3.4.8 Special P mobilization mechanisms

Two further processes were added for P uptake:

- an 'immobile pool' was added to the model, reflecting the difference between total P and available P, and equations were added for a potential mobilizing effect of crop or tree roots on this pool; in the current version there is no (increased) reverse process when the roots disappear,
- roots may (temporarily) influence the adsorption constant in their local neighbourhood by modifying pH and/or excreting organic anions competing for P sorption sites; equations were added for such effects in proportion to the root length density of crop and tree roots; the benefits of a higher potential P uptake are shared over tree and crop on the basis of a 'root synlocation' parameter, reflecting whether the spatial distribution of crop roots in a soil compartment are such that they are mixed or occur in separate clusters. This determines the part of the benefits of rhizosphere modification that will accrue to the species directly influencing the adsorption constant.

The first process (which in principle could be used for nitrogen as well (certain forms of root-induced N mineralization might fall under such a description, although a further reconciliation with organic N pools would be needed), and is governed by:

- N_Nutmob[Nutrient] or relative rate of transfer from the 'immobile' pool of nutrients to the 'mobile' or sorbed pool, due to processes other than root activity (day⁻¹);
- N_CNutmob[Nutrient] and N_TNutmob[Nutrient]Relative rate of transfer, per unit crop or tree root length density (cm cm⁻³), from the 'immobile' pool of nutrients to the 'mobile' or sorbed pool, due to root activity (day⁻¹ cm²).

The second process is governed by:

- $N_CRhizEffKaP$ and $N_TRhizEffKaP$, the proportional reduction of the apparent adsorption constant for P due to root activity of the crop, expressed as fraction of N_KaPdef per unit crop root length density ($day^{-1} cm^2$).
- $N_RtSynloc$, the root synlocation, or degree to which roots of the crop and tree are co-occurring within the various soil layers, affecting the way in which benefits of rhizosphere modification are shared.

3.4.9 N^{15} labeling

The standard version of WaNuLCAS no longer includes the sector that represents N^{15} labelling (earlier used by Edwin Rowe in the context of experiments in Lampung). On request, a new labelling sector was constructed that allows N^{15} in any of the 16 cells to be labelled and that tracks the N uptake of crop and tree, plus the relocation within the plant. The module does not yet include the vertical and lateral transfers of labelled N in the soil, nor the soil organic matter or litter layer pools.

3.4.10 Surface movement and incorporation of fertilizer

If there is heavy rainfall shortly after a fertilizer application, fertilizer can move along with overland flow of water, and can leave the plot in surface runoff. To simulate these processes (that can be quantitatively important under specific circumstances), WaNuLCAS now includes the process of dissolution of fertilizer grains and the lateral flow of the remaining fertilizer grains. Dissolved fertilizer will wash into the topsoil with rainfall, and/or can be mixed into the topsoil with a soil tillage operation (similar to the litter \rightarrow SOM transfer). Runoff loss from the plot occurs out of zone 1 (and may take two days with surface runoff if fertilizer is used in zone 2 but not in zone 1).

3.4.11 Green House Gas (GHG)

In a recent addition to the model, estimates of nitrogen oxide (N_2 , N_2O , NO) emissions are derived, on the basis of mineralization (the 'hole in the pipe' conceptual model; Verchot *et al.*, 2004) and denitrification. The form in which the gases emerge from the soil profile depends on the water-filled pore space.

Methane (CH_4) absorption and emissions are closely linked to the available pore space, as the entry of methane from the air into the soil profile

by diffusion tends to be the limiting step under dry conditions and wet conditions can lead to net emission from the soil.

The basic for predicting GHG emissions or absorption in WaNuLCAS model is:

- 1) the daily value of the water-filled pore space, that depends on the soil structure (as influenced by the soil biological activity if we switch the soil structure dynamics to 'on'), rainfall and water use by the vegetation,
- 2) for N₂O emissions, the dynamics of net nitrogen mineralization as it depends on organic inputs in interaction with mineral fertilizer.

Details for nitrogen oxides

Nitrogen oxide (NO_x) emissions are estimated on the basis of the net N mineralization according to Verchot *et al.* (1999), on the basis of research on deep oxisols in Brasil. The partitioning over nitrous and nitric oxide depends on water-filled pore space. To make it a complete estimate of all gaseous N losses the N₂ emissions are derived as multiplier on the nitrogen oxide emissions, again depending on water-filled pore space.

Verchot *et al.* (1998) derived:

$$\text{NOx flux (ng cm}^{-2} \text{ hr}^{-1}) = 0.954051 * \text{NetMineralization} - 0.093083 \quad [25]$$

with NetMineralization from disturbed samples of the topsoil (10 cm) in mg kg⁻¹ day⁻¹

The intercept in the equation creates negative estimates for net mineralization rates less than 0.098 mg kg⁻¹ day⁻¹, or 0.0098 g m⁻² day⁻¹ (35.8 kg ha⁻¹ year⁻¹). There were no data in this range in the original data set, and no negative flux estimates, so we can assign a zero value in this range, or look for an alternative model, without intercept.

Refitting the data, a power equation was derived that avoids the intercept and may be safer for use at low mineralization rates:

$$\text{NOx flux (ng cm}^{-2} \text{ hr}^{-1}) = 0.7212 * \text{NetMineralization}^{1.1699} \quad [26]$$

(R² = 0.636 versus R² = 0.751 for the linear equation)

In WaNuLCAS we have:

$$\text{NetMineralization} = \text{Mn2_SomMin1Exch[Zone,N]} / (\text{AF_DepthAct1[Zone]} * \text{W_BDLayer[1]}) \quad [27]$$

but this is actual; the disturbed samples during incubation may be expected to be 1.5 times the actual.

From Verchot *et al.* (1999):

$$\text{N}_2\text{O fraction} = \frac{(10^{(0.030001 \cdot 100 \cdot \text{W_WaterfilledPoreF1}[\text{Zone}] - 1.446925)})}{(1 + (10^{(0.030001 \cdot 100 \cdot \text{W_WaterfilledPoreF1}[\text{Zone}] - 1.446925)}))} \quad [28]$$

$$\text{NO fraction} = 1 - \text{N}_2\text{O fraction}$$

At higher water-filled pore fraction a substantial part of the gaseous emissions will occur as N_2 , not measured in the GHG data set. As a first estimate, we can assume that at 100% water-filled pore space ($\text{N}_2\text{O} + \text{NO}$) form 5% of total emissions, while at 50% water-filled pore space they are 95%. On this basis an N_2 part is added.

The Verchot equation only uses the net mineralization of the topsoil, but was derived from whole-profile chamber measurements of emissions regressed on top 10 cm net mineralization measurements. It thus implies litter mineralization and deeper soil N mineralization and emission processes for ($\text{N}_2\text{O} + \text{NO}$). The deeper layers may, however, contribute substantively to the overall N_2 flux. As a first approximation we assume that the total N_2 production from the layers below the topsoil has the same relationship with net mineralization as specified above, but that all comes out as N_2 .

On this basis, a total gaseous N losses estimate is added to the N balance, while data for predicted N_2O and NO emissions are available for each of the zones in the model.

Details for methane

A midrange estimate for the methane oxidation rate in aerated upland soils is $4 \text{ kg ha}^{-1} \text{ y}^{-1}$ (equivalent to $0.011 \text{ kg ha}^{-1} \text{ day}^{-1}$ or $0.0011 \text{ g m}^{-2} \text{ day}^{-1}$), while emissions under wet conditions can reach a similar level (Verchot *et al.*, 2004). For the model we need one additional parameter that defines the shape of the relationship between water-filled pore space and net emission. Fig. 3.14 provides examples for a range of values of the K_m parameter.

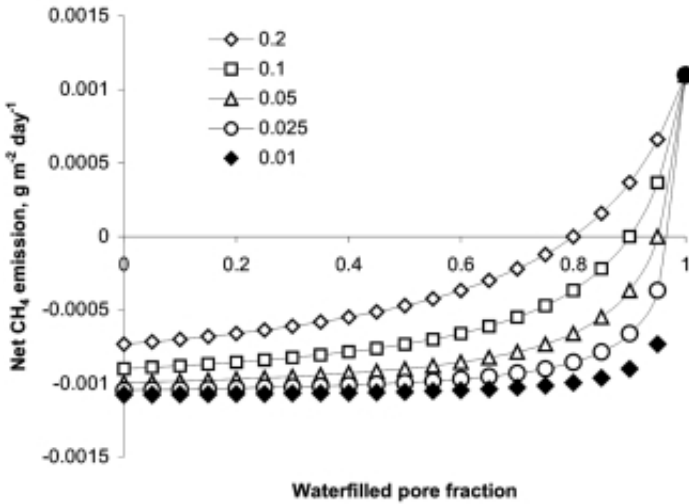

Figure 3.14. Methane flux (negative values indicate consumption, positive ones emission) as a function of the water-filled pore space, for a range of values of the GHG_CH₄_Km parameter (a dimension parameter relating to the difference in water-filled pore space (by decrease from fully saturated soil) that causes a 50% change in net emission, within the range defined by highest and lowest flux

An example

For a simulation on a degraded soil with cassava production and a local tree, we find the following response of gaseous N losses to modifications of the measured rainfall (Fig. 3.15):

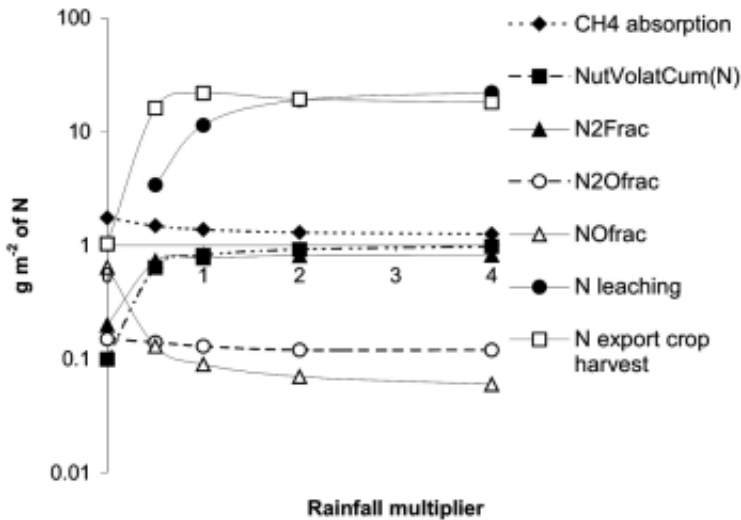

Figure 3.15. Effect of total rainfall, as simulated by using multiplier on daily rainfall amounts, on the gaseous N emissions from a soil (specified over NO and N₂O), leaching and N export from the plot in crop harvests over a 5 year period

3.5 Root distribution

3.5.1 Crop root length density

Three options exist for deriving the maximum root length density in each cell (Fig. 3.16):

Rt_ACType = 0 user input of maximum root length density for each layer i of zone j . Crop roots can grow and decay following a predetermined pattern, by multiplying a tabulated function [0,1] with this layer-specific maximum value. The maximum value may for example be based on the amount of roots at time of flowering, with a tabulated function describing root growth and decay as a function of crop stage reaching a value of 1 for $Cq_Stage = 1$ and declining for $1 < Cq_Stage < 2$). Users can modify the form of the graph which (in version 1.1) applies to all crops. Information on the relative root presence during a crop growing season can be obtained from minirhizotron data and analysis of sequential images.

Rt_ACType = 1 crop root length density within each zone decreases exponentially with depth:

$$LrvC(i, j) = Lra(i)DecWDepthC e^{(-DecWDepthC0.5(Depth(i, j)) + (Depth(i, j-1)))} \quad [29]$$

This function has two parameters:

$Rt_CLra(i)$ = total root length per unit area (cm cm^{-2}), which may depend on zone i ;

$Rt_CDecDepth$ = parameter (m^{-1}) governing the decrease with depth of root length density (at a depth of $0.699/Rt_CDecDepth$ the root length density has half of its value at the soil surface). The $Rt_CDecDepth$ parameter depends on the crop type, and may differ between zones i .

The function is evaluated for the half depth of each layer (average of total depth of current and previous layer). The $Rt_CLra(i)$ values as a function of crop stage can be obtained by multiplying a maximum value with a crop-stage dependent ratio (as for $Rt_ACType = 0$).

Rt_ACType = 2 Uses the same exponential root distribution, but involves a 'functional equilibrium' response (Van Noordwijk and Van de Geijn, 1996), allowing the relative allocation of growth to roots to increase when water and/or nitrogen limit plant growth. A simple representation is included of 'local response' by which the vertical distribution of roots is influenced by the

Table 3.6 Options for deriving crop root distribution; in WaNuLCAS 3.0.1

Rt_AC Type	Distribution of roots over soil layers	Dynamics of root growth and decay
0	User input value of Lrvmax	RelRoot... as function of crop stage
1	Exponential function (root diffusion into homogeneous soil); Rt_CDecDepth and maximum Lra(l) as inputs	As in 0
2	As in 1, but Rt_CLra(i) derived from root biomass; Rt_CDecDepth can be modified from the initial input values based on 'local response', modified by Rt_CDistRespFor Rt_CDistResp : 0 => no response -1 mild response 1 => change in Rt_CDecDepth proportional to inverse of relative depth of uptake > 1 strong response of root distribution to uneven uptake success of the most limiting resource	Driven by total crop biomass, root weight ratio as a function of crop stage (Cr_RtAlloc), specific root length (Cr_RtSRL) and mean root longevity (Cr_RtHalfLife, in exponential decay); The degree of 'functional equilibrium' response in root/shoot allocation is determined by Cr_RtAllocResp: 0 => no response, => fairly late response to stress, => proportional increase of root allocation with stress, 1 => rapid response to stress

relative success of roots in taking up the most limiting resource in upper or lower layers of the profile. Both responses are regulated by a parameter (Cr_RtAllocResp and Rt_CDistResp, respectively) determining the degree of response. These parameter are, however, not easily measured independently and the user may have to explore a range of values. Functional as well as local response can be 'turned off' by setting the responsiveness parameters at 0.

For Rt_ACType = 2, the value of Rt_CLra(*i*) is derived from root biomass multiplied with C_SRL, the specific root length or root length per unit dry weight (m g⁻¹). Root biomass is derived from daily increments in plant biomass, multiplied with the root allocation fraction Cr_RtAllocAct. The latter is calculated from a base-line value Cr_RtAlloc, multiplied with a tabulated function of Cq_stage, and potentially modified to account for functional equilibrium and local response. Cr_RtAllocAct can be modified from Cr_RtAlloc by the minimum of the current water and nitrogen stress in the plant, modified by the parameter Cr_RtAllocResp, as indicated in Table 3.6.

Root decay is implemented by daily removing a fraction of - 0.69/Cr_RtHalfLife, where the latter is measured in days and can e.g. be derived from sequential observations with minirhizotrons. In version 1.2 root turnover is not influenced by water or nitrogen stress, but such a feedback may be included in future versions.

For Rt_ACType 2 it is also possible to modify the Rt_CDecDepth parameter on the basis of current uptake distribution. The response is based

on N uptake if $C_NPosGro < CW_PosGro$, and otherwise by water uptake. We first calculated the relative depth of uptake, by the weighted sum of depth of layer multiplied by uptake per unit root length. For relatively high uptake success in deep layers $Rt_CDecDepth$ will decrease, for success of shallow roots it will increase. The degree of response is regulated by $Rt_CDistResp$, as indicated in Table 3.6. When high values of this responsiveness are chosen, the calculated change in root length of an individual layer could exceed the total change in root length from decay and new root growth. We prevent this, by capping off the change based on the proportional change in total root length.

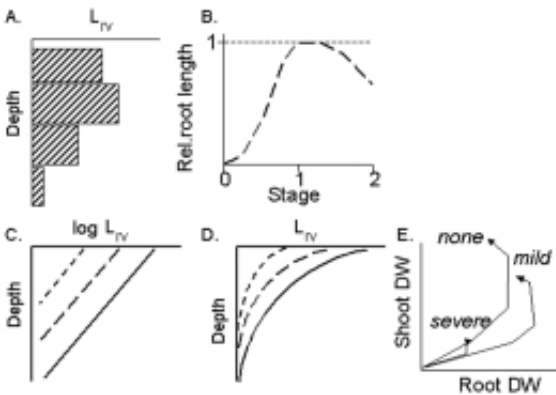

Figure 3.16. Distribution and development of crop root length density; A. Arbitrarily set values of maximum Lrv per depth interval ($Rt_ACType = 0$); B. multiplier to derive daily actual Lrv from maximum values per layer ($Rt_ACType = 0$ and 1); C. Exponential decrease of Lrv with depth (on log scale), D. idem (linear scale) ($Rt_ACType = 1$); E. Relationship between shoot and root dry weight under no, mild and severe water or N stress ($Rt_ACType = 2$)

3.5.2 Tree root length density

Four options exist for obtaining its value for each cell (zone * depth) (Fig. 3.17):

Rt_ATTType = 0 user input of root length density for each cell ij , and

Rt_ATTType = 1 tree roots distributed according to an elliptical function:

$$Lrv(i, j) = LraX0 * RtTDecDepth * e^{-RtTDecDepth \sqrt{Depth_i^2 + (RtDistShap * eHorDist_i)^2}} \quad [30]$$

This function has three parameters:

T_LraX0 = total root length per unit area ($cm\ cm^{-2}$) at a distance X of 0 from the tree stem

Rt_TDecDepth = parameter (m⁻¹) governing the decrease with depth of root length density (for X = 0, at a depth of 0.699/DecWDepth the root length density has half of its value at the soil surface),

Rt_TDistShape = dimensionless parameter governing the shape of the tree root system; values less than 1 indicate shallow-but-wide root systems, values of 1 give a circular symmetry, and values > 1 indicate deep-but-narrow root systems.

The function is evaluated for all four corners of each cell and a logarithmic average is determined.

where the Lrv₀₀ .. Lrv₁₁ refer to the four corners. (In fact the function is just evaluated once for an elliptically averaged position).

$$Lrv = e^{0.25 (\ln(Lrv_{00}) + \ln(Lrv_{01}) + \ln(Lrv_{10}) + \ln(Lrv_{11}))} \quad [31]$$

For **Rt_ATTtype = 2** a functional equilibrium and local response are implemented, as for crop roots, regulated by T_RtAllocResp and Rt_TDistResp. The main difference is that there is no dependence on crop stage, and that the local response has a vertical (Rt_DecDepth) as well as a horizontal (Rt_DistShape) component. Both are regulated by the same Rt_TDistResp parameter.

Rt_ATTtype = 3 simulates fine and coarse roots. This option describes the dynamics of fine tree root density in soil voxels (various layers and zones of the soil) and the consequences for coarse roots development to keep up with the transport demand. The dynamics of fine roots is modelled using voxel

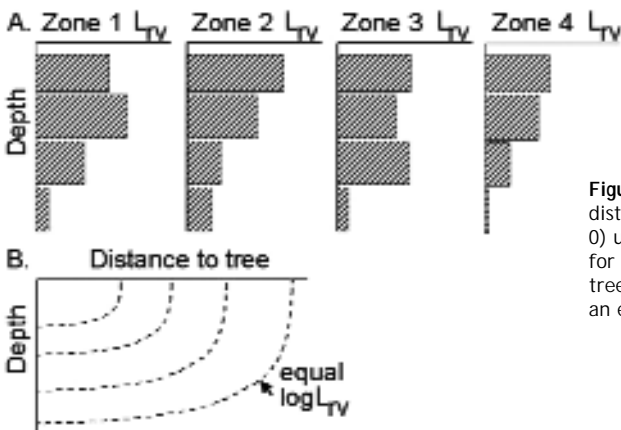

Figure 3.17. Root length density distribution for tree; A. (Rt_ATTtype = 0) user input of root length density for each cell ij; B. (Rt_ATTtype = 1) tree roots distributed according to an elliptical function

automata rules. The allocation of fine roots to a voxel is based on current root length and its previous-day uptake efficiency. A stand alone Stella model is available to learn more about this tree root dynamics option.

3.5.3 Specific root length of tree root systems

For $Rt_ATType = 2$ we use (inverse) allometric equations to relate proximal root diameters to total root biomass, and drive the specific root length (length per unit biomass) as a function of this diameter (compare section 3.8.4 for aboveground allometric equations).

For a single branched root we can formulate for biomass and length, respectively:

$$T_Root = Rt_TWghtDiam1 Rt_T ProxDiam^{Rt_TWghtDiamSlope} \quad [32]$$

$$Rt_TLength = Rt_TLengDiam1 Rt_T ProxDiam^{Rt_TLengDiamSlope} \quad [33]$$

For a root system consisting of a number of roots of different diameters, we assume that the cumulative frequency distribution of proximal root diameters can be approximated by:

$$CumFreq = (T ProxDiam / T ProxDiam_{max})^{T ProxGini} \quad [34]$$

where $TProxGini$ is a parameter equivalent to a Gini coefficient as used in studies of income distribution, and hence (using D in stead of $TProxDiam$, a_1 for $T_DiamRtWght1$, b_1 for $T_DiamSlopeRtWght$, a_2 for $T_DiamRtLeng1$, b_2 for $T_DiamSlopeRtLeng$ and n for $T_ProxGini$):

$$Freq(D) = dCumfreq / dD = T ProxGini D_{max}^{-T ProxGini} D^{(T ProxGini-1)} \quad [35]$$

We can derive the total dry weight T_Root (Wt) from 24 and 26 as:

$$T_Root = \int_0^{D_{max}} Freq W dD = a_1 n D_{max}^{-n} \int_0^{D_{max}} D^{b_1+n-1} dD = a_1 n D_{max}^{b_1} / (b_1 + n) \quad [36]$$

Similarly, for the sum of proximal root diameter squares, we obtain:

$$SumD_r^2 = n D_{max}^2 / (2 + n) \quad [37]$$

and the equivalent single proximal root diameter as the square root of $SumD_r^2$.

Equations (28) and (29) can be used to derive the maximum proximal root diameter D_{\max} :

$$D_{\max} = (W_t(b_1 + n)/(a_1 n))^{1/b_1} = (\text{sum}D_r^2(2 + n)/n)^{0.5} \quad [38]$$

Relations between W_t and SumDr^2 can now be obtained as:

$$W_t = ((a_1 n)/(b_1 + n)) \{ \text{sum}D_r^2(2 + n)/n \}^{b_1/2} \quad [39]$$

and

$$\text{sum}D_r^2 = n/(2 + n) \{ W_t(b_1 + n)/(a_1 n) \}^{2/b_1} \quad [40]$$

Similarly, from (25) and (26) we obtain $R_t_TLenght(L_t)$ as:

$$L_t = (a_2 n)/(b_2 + n) \{ \text{sum}D_r^2(n + 2)/n \}^{2/2} \quad [41]$$

and from [30] and [33]:

$$L_t = (a_2 n)/(b_2 + n) \{ W_t(b_1 + n)/(a_1 n) \}^{b_2/b_1} \quad [42]$$

Finally, the specific root length SRL is obtained as function of W_t

$$SRL(W_t) = L_t / W_t = (a_2 n)/(b_2 + n) \{ (b_1 + n)/(a_1 n) \}^{b_2/b_1} W_t^{b_2/b_1 - 1} \quad [43]$$

Equation (35) is used in the model.

3.5.4 Root diameter and mycorrhiza

Tree and crop are likely to differ in root diameter. As root diameter has an effect on the potential uptake rate, an 'average' root diameter in each layer and zone is needed for the uptake function and a way to estimate the equivalent effective root length of each component at such a diameter. A simple approach is used in WaNuLCAS, based on De Willigen and Van Noordwijk (1987) and Van Noordwijk and Brouwer (1997), comparing roots of different diameter on the basis of the product of root length and SQRT(root diameter); this method of averaging makes the uptake function least sensitive to diameter (see Van Noordwijk and Brouwer, 1997; Fig. 3.18)

$$RtDiamAV_{ij} = \left[\frac{Rt_CLrv_{ij} \sqrt{Rt_CDiam} + Rt_TLrv_{ij} \sqrt{Rt_TDiam}}{Rt_CLrv_{ij} + Rt_TLrv_{ij}} \right]^2 \quad \dots \quad [44]$$

Based on this rule for adding roots of different diameter on the basis of the square root of their diameter, we can also get a first approach to the effects of mycorrhizal hyphae. The total length of hyphae can be derived from the fraction of roots that is mycorrhizal ($Rt_MCInfFrac$ or $Rt_MTInfFrac$), and the length of hyphae per unit length of mycorrhizal root (Rt_MCHypL or Rt_MTHypL).

The effective root length then can be derived as:

which effectively converts the mycorrhizal hyphae into an equivalent length at the diameter of the roots. This option is provided for both crop and tree.

$$EffLrvC_{ij} = LrvC_{ij} \left[1 + \frac{Inffrac \cdot HypLeng \cdot \sqrt{HypDiam}}{\sqrt{RtDiamC}} \right] \quad [45]$$

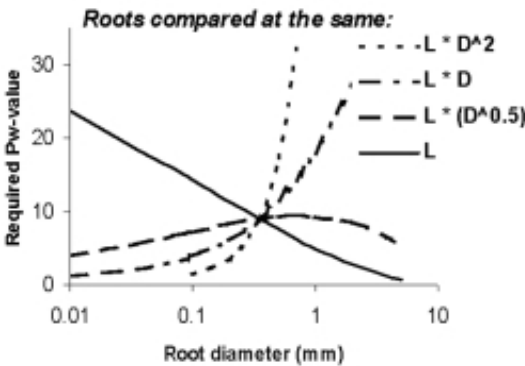

Figure 3.18. Effect of root diameter on potential uptake when root systems of different diameter are compared at equal length, root surface area or volume (weight): the smallest effect of root diameter exists when root length times the square root of the root diameter is used (Van Noordwijk and Brouwer, 1997)

3.6 Light capture

Light capture is calculated on the basis of the leaf area index of the tree(s) and crop (T_LAI [tree] and C_LAI) for each zone, and their relative heights. In each zone the parameters T_CanLow [tree], T_CanUp [tree], C_CanLow , C_CanUp indicate lower and upper boundaries of crop and tree canopy, respectively. LAI is assumed to be homogeneously distributed between these boundaries.

Light capture by the trees is separated in light captured by branches (based on their vertical projection area in the 'branch area index' or BAI) and leaves (based on leaf area index, LAI), while only the LAI part of total capture is used by the plants. This option allows to account for shading by

trees when they are leafless, as *Faidherbia albida* is during the crop growing season. The ratio of BAI and LAI depends on the canopy architecture, leaf size and age of the tree. For older trees with small leaf sizes BAI can be similar to LAI (Van Noordwijk and Ong, 1999).

The current approach has evolved from that in WaNuLCAS 1. where only a single tree plus crop component was simulated. In that case, three strata were distinguished in the canopy: an upper one (with only one type of leaves), a mixed one (with both types of leaves present) and a lower one (with one only) (Fig. 3.19).

If light capture of n plants is to be accounted for in the same way, a total of $2n-1$ canopy layers should be distinguished, with all boundaries determined by either an upper or a lower boundary of one of the components. In WaNuLCAS 3.01 we chose, however, to use only n canopy layers, using only the upper bounds of the component canopies as determinants. This choice means that for any plant type the light capture above its canopy is correctly calculated, but in the sharing of light within a canopy layer the calculations assume that all plant types present in that layer have leaves spread evenly within that layer.

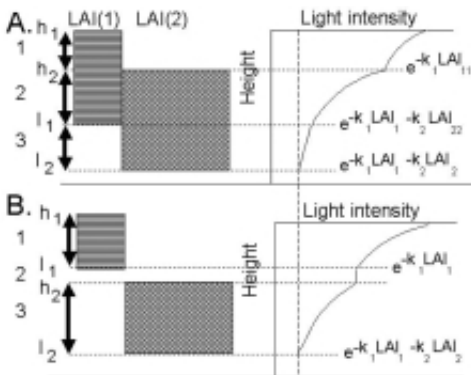

Figure 3.19. Light capture in a two-component leaf canopy, as used in WaNuLCAS 1.0; three zones can be distinguished: an upper zone with only one species, a middle one with both and a lower one with only one (usually not the same as in the upper zone); total light capture in the shared zone may be apportioned relative to the leaf area index of both species in that zone (compare Kropff and Van Laar, 1993)

The errors made in this approximation are generally less than 1% of incoming radiation, but under specific parameter conditions light capture by a component can have a relative error of up to 25% (Fig. 3.20)

Specifically, the following steps are taken in WaNuLCAS 3.01 in the daily calculations per zone:

1. sort the four values (three trees plus crop) of upper canopy boundary (CanUp_i),

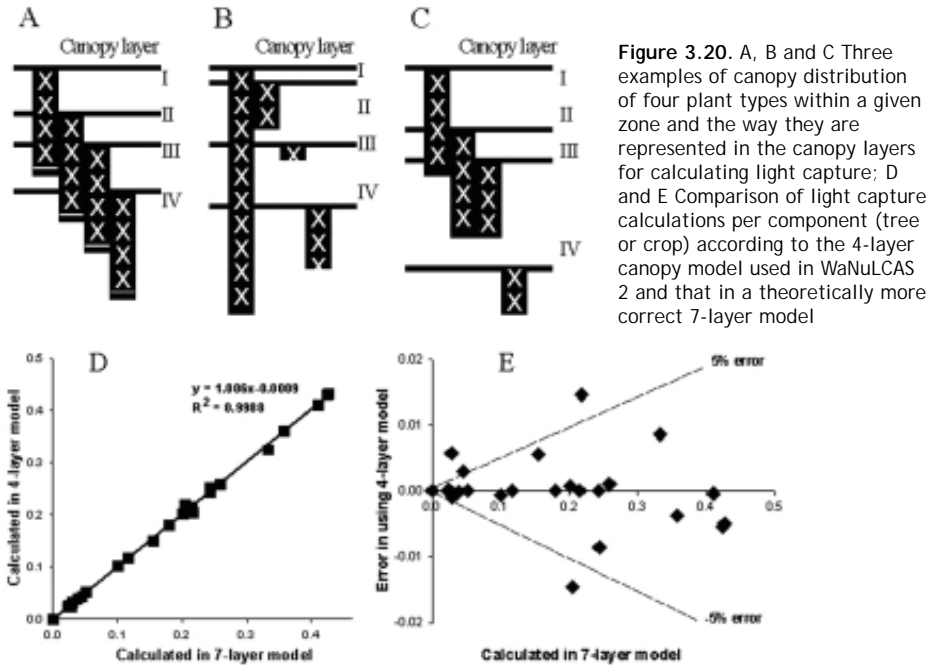

Figure 3.20. A, B and C Three examples of canopy distribution of four plant types within a given zone and the way they are represented in the canopy layers for calculating light capture; D and E Comparison of light capture calculations per component (tree or crop) according to the 4-layer canopy model used in WaNuLCAS 2 and that in a theoretically more correct 7-layer model

2. calculate the canopy boundary values $CanBound_j$ from these ranked values (for $j = 1$ take the highest, for $j = 4$ the lowest $CanUp$ value)
3. calculate the LAI of each plant component i in each canopy layer j by assuming the leaf area to be evenly distributed within its canopy:

$$LAI_{ij} = LAI_i \cdot (MIN(CanUp_j, CanBound_j) - MAX(CanLow_i, CanBound_{j+1})) / (CanUp_i - CanLow_i) \quad [46]$$

$CanBound_5$ is assumed to be zero (any value smaller or equal to $\min(CanLow_i)$ will give the same result).

4. calculate total light capture in each canopy layer on the basis of Beer's law for all components, starting at the top and accounting for light captured above the layer:

$$TotLightCa p_j = 1 - \sum_{k=1}^{j-1} TotLightCa p_k - e^{-\sum_i (kLLight_i * LAI_i - kBLight_i * BAL_i)} \quad [47]$$

where the $kLLight_i$ and $kBLight_i$ values represent the light extinction coefficients for leaves and branches, respectively.

5. share the light captured in a layer over the contributing components,

$$LightCap_{ij} = TotLightCap_j \frac{kLLight_i LAI_{ij}}{\sum_i (kLLight_i * LAI_i - kBLight_i * BAI_i)} \quad [48]$$

6. accumulate the light captured by each tree or crop over the various canopy layers.

Our choice for n rather than $2n-1$ layers introduces an inaccuracy in step 5 in as far as the lower canopy boundaries of the various components within a layer do not coincide.

3.7 Crop growth

3.7.1. Basic Relations

Major relationships in the daily cycle of calculating crop biomass accumulation (Fig. 3.21) are:

1. calculation of crop leaf area index on the basis of shoot biomass, leaf weight ratio (LWR, leaf weight as fraction of total shoot weight) and specific leaf area (SLA, $m^2 g^{-1}$),
2. calculation of canopy height on the basis of biomass and physiological stage (assuming height growth to stop at flowering),
3. calculation of the relative light capture on the basis of LAI of both tree and crop (see section 3.6),
4. calculation of the potential growth rate of the crop for that day, by multiplying relative light capture with the light use efficiency (dry matter production per unit light captured) and maximum net growth rate ($kg m^{-2} day^{-1}$), which is an input to the model and can be derived from more physiologically explicit models of potential crop growth under the given climate. The maximum net growth rate is supposed to include respiration losses for maintenance of existing tissues as well as for the formation of new ones. There is an option to specifically define maintenance respiration. This option enabled weed to be shaded by tree (see 3.7.3 on Maintenance Respiration)
5. calculation of transpirational demand on the basis of this light-limited potential growth rate and a potential water use efficiency (dry matter production per unit water transpired), which will depend on the crop species,

6. calculation of whether actual water uptake can meet this transpirational demand (see section 3.3); the factor CW_PotGro is determined as the ratio of actual water use and transpirational demand,
7. calculation of the N limitations on growth on the basis of CN_PotGro (see section 3.4),
8. calculation of real dry matter production as the product of $C_PotGroRed$ and the minimum of CN_PosGro and CW_PosGro .
9. Calculation of litterfall, if the actual LAI of the crop exceeds the maximum (C_LAI_{max} , which is crop type dependent), a proportional part of the stem and leave biomass is transferred to the litter layer.

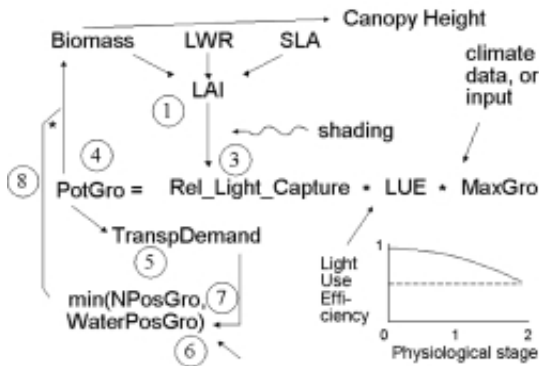

Figure 3.21. Major relationships in the daily cycle of calculating crop biomass accumulation

The model thus assumes that under N deficiency crops keep their potential transpiration rate, but have a reduced actual water use efficiency (dry matter production per unit water use). Under water stress, N uptake will be reduced as biomass accumulation slows down and thus demand is decreasing.

3.7.2 Deriving stage-dependent potential growth rates and allocation to harvested organs for situations without shading, water or nitrogen deficiency

A number of the allocation functions depends on the 'physiological age' of the crop. A basic length of the vegetative and generative stage is given as model input ($Cq_TimeVeg[season]$ and $Cq_TimeGen[season]$, respectively) for each crop. These values are used to re-scale time into 'crop-age'; for environments where temperature is a major variable, crop development can be driven by a temperature sum rather than by time.

In WaNuLCAS 3.01 the following allocation functions depend on crop stage:

- harvest allocation (Cq_HarvAlloc),
- specific leaf area (Cq_SLA),
- leaf weight ratio (Cq_LWR),
- relative light use efficiency (Cq_ReLLUE).

These functions can be user-defined from experimental data of crops growing in full sunlight in the local climate with adequate supply of nitrogen and water, or from more detailed physiological models. Figure 3.22 and 3.23 give examples of basic allocation functions derived from the Wofost model (data provided by Dr. P. de Willigen, AB-DLO Haren the Netherlands), using climate data for Lampung (Indonesia) and 'standard' parameter settings for cassava, (upland) rice, maize, groundnut and cowpea. From data such as this taking the ratio of green leaf and total biomass can directly derive LWR. To obtain ReLLUE the growth rate (dW/dt) is divided by the estimated light capture (on the basis of LAI - this calculation requires parameter values for SLA and light extinction coefficient)

The sheet 'Deriving Crop Growth' in the WaNHELP.xls spreadsheet takes the following steps in converting output of a potential crop growth simulation (daily predicted biomass in leaves, stems and storage organ(or grain)), into the input parameters which are used in the 'Crop Growth' spreadsheet.

Input columns:

DwLv[time]= leaves biomass in dry weight ($\text{kg ha}^{-1} \text{ day}^{-1}$)

DwSt[time]= stem biomass in dry weight ($\text{kg ha}^{-1} \text{ day}^{-1}$)

DwSo[time] = storage biomass in dry weight ($\text{kg ha}^{-1} \text{ day}^{-1}$)

SLA[time] = specific leaf area in $\text{m}^2 \text{ g}^{-1}$

Cq_kLight = light extinction coefficient, as fixed value over time

Derivations:

DwTot[time] = total dry weight biomass = DwLv + DwSt + DwSo

GroMax = maximum daily increment in aboveground plant biomass =
 $\max(\text{DwTot})$ ($\text{kg ha}^{-1} \text{ day}^{-1}$)

LWR[time] = leaf weight ratio = $\text{DwLv}[\text{time}] / (\text{DwLv}[\text{time}] + \text{DwSt}[\text{time}])$

TimeVeg = length of vegetative stage period = time of flowering or last day before first value of DwSt is recorded

TimeGen = length of generative stage period = time to harvest - TimeVeg

Stage = Increased of plant growth stage = time/TimeVeg for time < TimeVeg and $(1 + (\text{time} - \text{TimeVeg})/\text{TimeGen})$ for time \geq TimeVeg

Deriving apparent light use efficiency

Calculate daily increment in total dry weight (logarithmic average over preceding and subsequent period):

$$\text{BiomInc}[\text{time}] = \exp(0.5 * (\ln (dDwTot/dt)_{\text{preceding}} + \ln (dDwTot/dt)_{\text{subsequent}}))$$

Calculate daily relative light capture, the factor 10 000 converts from ha to m²:

$$\text{RelLightCap}[\text{time}] = 1 - \exp(-k * \text{DwLv} * \text{SLA}/10000)$$

Calculate relative daily growth per unit light capture (relative to the maximum growth rate, which implicitly reflects the radiation level):

$$\text{RelLUE}[\text{time}] = (dDwTot/dt) / (\text{GroMax} * \text{RelLightCap})$$

Deriving apparent remobilization from stems and leaves and allocation to storage organs

Daily increment in storage organ: dDwSo/dt

Apparent remobilization from leaf and stem dry weight during generative stage:

$$\text{Remobfrac}[\text{time}] = (dDwSo/dt - dDwTot/dt) / (\text{DwLv} + \text{DwSt})$$

Value of Remobfrac which can be used for the whole growing season: max(Remobfrac[time])

Daily allocation to storage organs:

$$\text{HarvAlloc}[\text{time}] = (dDwSo/dt) / ((dDwTot/dt) + \text{Remobfrac} * (\text{DwLv} + \text{DwSt}))$$

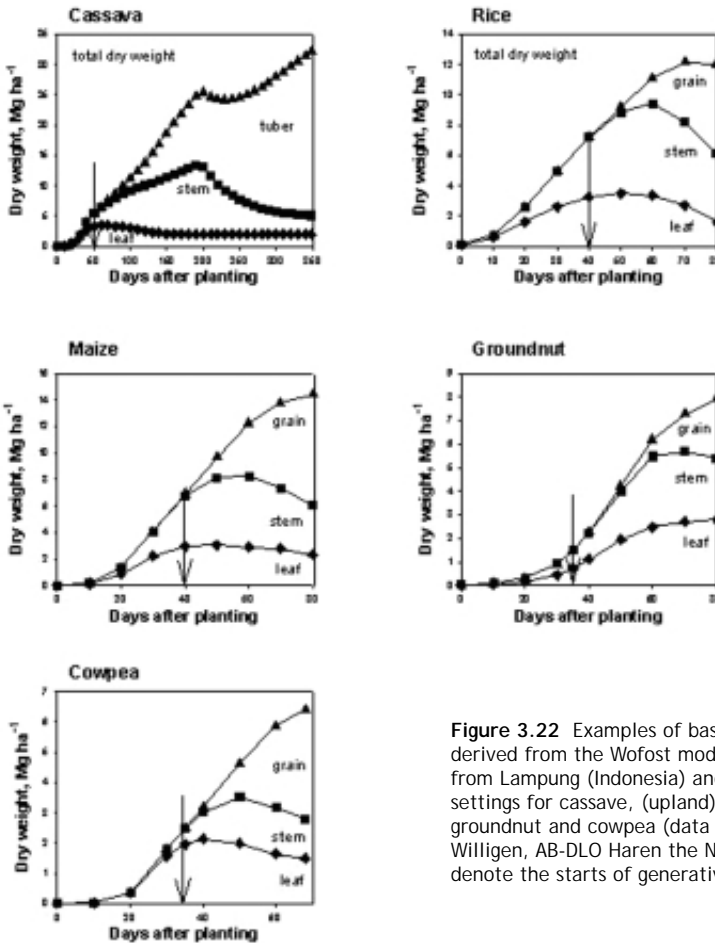

Figure 3.22 Examples of basic allocation functions derived from the Wofost model using climate data from Lampung (Indonesia) and 'standard' parameter settings for cassava, (upland) rice, maize, groundnut and cowpea (data provided by Dr. P. de Willigen, AB-DLO Haren the Netherlands). Arrows denote the starts of generative stage (Cq_Stage=1)

Converting time-dependent variates into crop stage dependent ones

The derived parameters LWR[time], SLA[time], RelLUE[time] and HarvAlloc[time] are now converted to crop-stage dependent equivalents:

To convert the data which may have unequal intervals into the equal-interval format expected by Stella, the stage dependent variates are plotted in a graph with stage as X-axis. Manually we read in values at constant intervals (helped by grid-lines in the graph) into the columns Cq_CLWR[stage], Cq_CSLA[stage], Cq_CRelLUE[stage] and CqCHarvAlloc[stage], respectively.

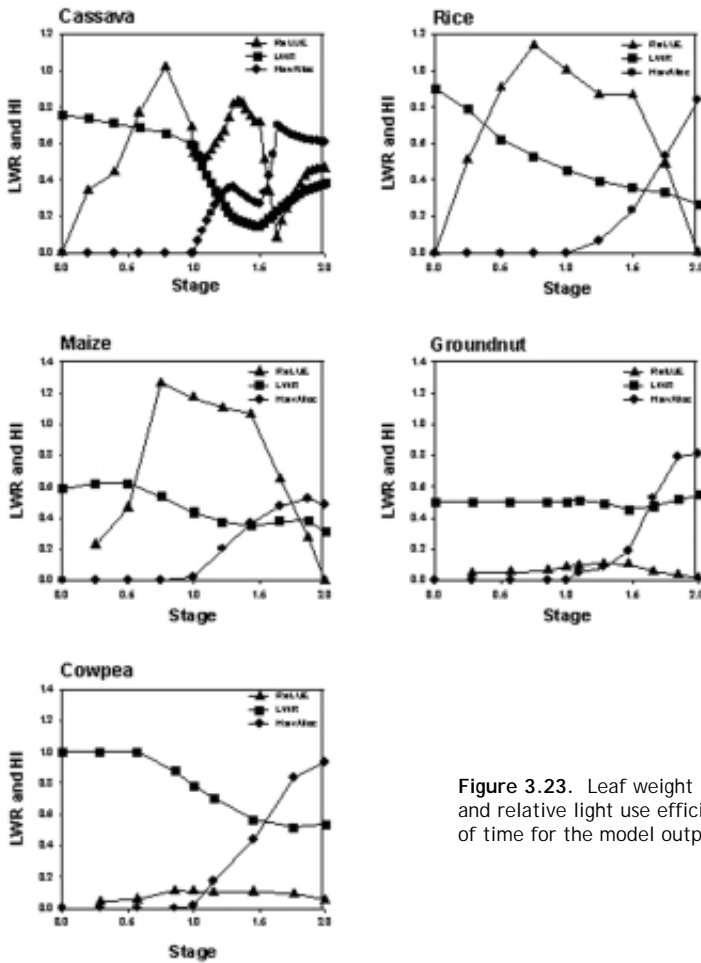

Figure 3.23. Leaf weight ratio, harvest allocation and relative light use efficiency rate as a function of time for the model output of figure 3.15

As illustrated in Fig. 3.24 for maize, the daily interpolation does not exactly match the Wofost input (based on 10 day recording intervals), but errors in daily rates as well as cumulative amounts stay within generally acceptable limits (5%); towards the end of the crop development, however, the Wofost model (as well as proper field data) show a decline in total dry weight as respiration exceeds photosynthesis; in Wanulcas we do not explicitly represent respiration losses or account for negative growth rates, but the losses are accounted for by assuming a lower net growth rate in the preceding period. This approach, however, leads to deviations in the harvest index.

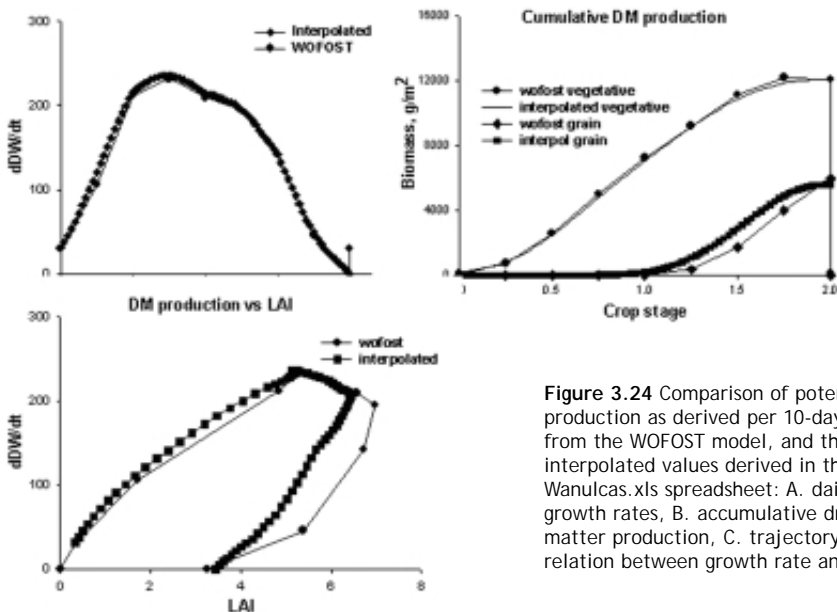

Figure 3.24 Comparison of potential production as derived per 10-day interval from the WOFOST model, and the daily interpolated values derived in the Wanulcas.xls spreadsheet: A. daily growth rates, B. accumulative dry matter production, C. trajectory of the relation between growth rate and LAI

In Wanulcas a reverse procedure is used to derive the daily potential growth rate (Cq_{from} from the actual relative light capture (based on crop LAI as well as shading) multiplied by Cq_{RelLUE} and $Cq_{GrowMax}$. [This assumes that potential growth rates are proportional to light capture]

Effectively we allow the user to use this simulated data for modified crop phenology (changes in TimeVeg and TimeGen) as well as modified maximum growth rates, as simple ways to apply it to modified climatic conditions. If large modifications are made it would be safer to derive fresh inputs from a potential crop growth model for the new situation.

If no potential growth simulations are available, the user may enter other types of estimates of the biomass of leaves, stems and storage organs into the spreadsheet and otherwise follow the procedure outlined.

3.7.3. Maintenance Respiration

Maintenance respiration in WaNuLCAS is specifically address the ability to 'shading out weeds'. We use two additional concepts:

- 1) maintenance respiration from the growth reserve pool, at a rate of X % of current biomass per day, that leads to a 'compensation point', or light level below which the crop will start to decrease in reserves,

2) if growth reserves (dry weight) are zero the plant will die

We implement it by using the following additional parameters:

C_ApplyMaintResp? is a on/off switch for applying the maintenance respiration; for a default value of 0 all the rest is ignored

C_RespPerBiomass is the relative use of resources for maintenance respiration per unit biomass

C_RelRespRt is the relative weighting factor for roots as part of total biomass as used for maintenance respiration

C_RelRespStLv is the relative weighting factor for stem&leaves as part of total biomass as used for maintenance respiration

C_RelRespCurrHarv is the relative weighting factor for developing fruits as part of total biomass as used for maintenance respiration

C_RelRespGroRes is the relative weighting factor for growth reserves as part of total biomass as used for maintenance respiration

C_RespTemp is a graphical relation between temperature and maintenance respiration

C_GroResMobFrac is the fraction of growth reserves that is used for growth of plant organs such as stems&leaves on a daily basis

These parameters are set within the STELLA model and not yet part of Crop Library in Excel.

3.8 Tree growth

3.8.1 Tree growth stage

For the trees a physiological growth stage is defined in the [0 - 1] range for the vegetative stage up to the first flowering event, and in the [1 - 2] range for flowering and fruit ripening. After fruit ripeness the tree returns to stage 1 (rather than dies, as is the case for 'annuals'). The parameters governing tree growth stage are:

T_TimeVeg - duration [days] of initial vegetative period before first flowering

T_InitStage - tree growth stage at start of simulation

T_StageAfterPrun - growth stage to which trees are returned after a pruning event

T_TimeGenCycle - duration [days] of a flowering - fruit ripeness cycle

T_FlowerDOYbeg - first day of year at which flowering can occur (provided stage = 1.0)

T_FlowerDOYends - last day of year at which flowering can occur

T_FruitAllocFrac - fraction of current growth resources in the tree allocated to developing fruits

T_FruitHarvFrac - fraction of ripe fruit biomass and nutrients harvested from the plot

When the trees are pruned, all fruit biomass is removed from the tree and may be partly harvested from the plot, along with vegetative pruned biomass, as governed by the T_PrunHarvFrac.

When the growth stage reaches 2.0, all fruit biomass is removed from the tree, and the T_FruitHarvFrac part of it is harvested from the plot, the remainder returned as mulch.

On a daily basis a fraction of the T_Fruit biomass pool can be removed by frugivory and fruit abortion, as governed by T_frugivory&abortionFrac, and returned to the soil as mulch.

3.8.2 Canopy and support structure

WaNuLCAS includes a simple description of canopy shape, aboveground biomass production and litterfall; these rules are applied if the T_ApplyFBARules? switch is put at 0. In the model, the calculated aboveground tree biomass increment is first of all allocated to a buffer of 'carbohydrate reserves' and is allocated from there to make:

- a canopy, consisting of leaves and small branches (<2 cm diameter),
- a support structure, consisting of supporting branches and a trunk,
- replacement of leaves and branches transferred to 'litterfall'

$$\Delta Biom = \Delta Canopy + \Delta Support + \Delta Litterfall \quad [49]$$

The allocation over canopy and support structures depends on the size of the tree. while litterfall is related to the development of 'bare branches' in the support structure.

Within the canopy, the increment in leaf biomass is calculated from:

- LWR (leaf weight as fraction of total biomass in the canopy),
- SLA (specific leaf area, or leaf area per unit leaf weight).

$$\Delta Leafarea = \Delta Canopy * LWR * SLA \quad [50]$$

A half ellipse on a stick (forming an 'umbrella' approximates tree canopy shapes, with as parameters:

- R, radius (half of the width),
- H, height (measured above the bare stem section); the canopy height consists of a green part and, above a certain total height, a bare section,
- S, shape, or ratio of radius and height of the half ellipse (or of width and total height of a full ellipse; $S = R/H$; $S = 1$ indicates a circle),
- LAI-canopy (leaf area index within the canopy), which can vary between LAI_{min} and LAI_{max}.
- An alternative formulation that is activated when T_ApplyFBARules? = 1 is described in section 3.8.4.

3.8.3 Daily cycle of calculations

The sequence of events during a pruning/regrowth cycle is illustrated in Fig. 3.18

In the first stages of regrowth after pruning, growth is based on the carbohydrate reserves in the bare trunk which remained after pruning and is thus dominated by the fraction which can be converted daily. Once green leaves start to function, the carbohydrate reserve pool can be replenished and growth rates can increase. At first the canopy extends with a minimum LAI within the canopy, LAI_{min}. Both width and height can be calculated from the total leaf area, LAI_{min} and the shape of the ellipse (which is assumed to be constant, but could be made size-dependent if more specific data are available).

$$R = Leafarea / LAI_{min} \quad [51]$$

$$H = R / S \quad [52]$$

By the time the calculated canopy height exceeds the 'green-canopy height', litterfall is supposed to start. New biomass production continues to be allocated to leaves (T_LWR) and stems (1 - T_LWTR), but only the stems is added to tree biomass and the new leaves are simply replacing litterfall. If the

maximum canopy width is reached, the canopy can gradually increase in LAI from LAI_{min} to LAI_{max}.

$$\Delta height = leafgrowth / (LAI_{max} * Maxwidth) \quad [53]$$

If LAI_{can} reaches LAI_{max}, the canopy will gradually move upwards. All new leaf growth is offset by litterfall. The increment of tree-height follows from: For the 'support structure' a tabulated function can be used to allocate dry weight. Alternatively, allometric equations based on fractal branching properties can be used (not yet)

Pruning events are described in section 3.10.7.

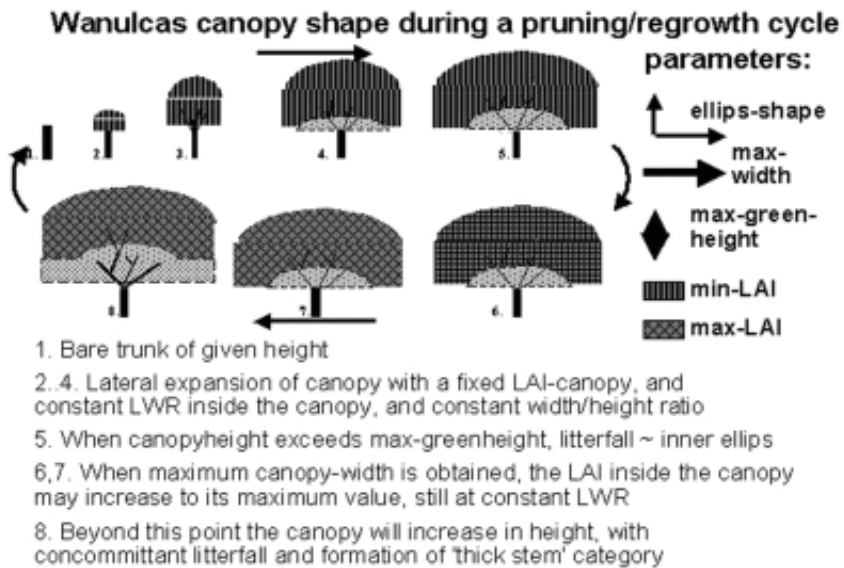

Figure 3.25. Tree canopy shape during a pruning - regrowth cycle

3.8.4 Tree diameter and allometric biomass allocation rules

A number of allometric biomass equations (of the general form: $Y = a D^b$) is commonly used to relate biomass in specific fractions (total aboveground, leaves+twigs, branches, total belowground) or total root length to the diameter of the main stem, or the equivalent diameter of all proximal roots (for belowground application see section 3.5.3). The spreadsheet 'Functional BranchAnalysis' (FBA) that is released as a companion to WaNuLCAS

provides a way to derive parameters of these allometric equations on the basis of parameters that can be relatively easily observed (without large scale destructive sampling).

In WaNuLCAS we use the general biomass - stem diameter relation in inverse form to derive stem diameter from the total tree biomass as it develops on the basis of the growth rules. The relation

$$T_BiomAG = T_BiomDiam \mid T_StemDiam^{T_BiomDiamSlope} \quad [54]$$

can be inverted to obtain

$$T_StemDiam = (T_BiomAG / T_BiomDiam)^{1/T_BiomDiamSlope} \quad [55]$$

Aboveground biomass of a tree may decrease, e.g. due to litterfall or pruning, without causing a direct reduction in stem diameter. In WaNuLCAS we therefore keep track of the stem diameter via the maximum aboveground biomass obtained so far in the simulation. The $T_StemDiam$ parameter is used as indicator for the readiness for tapping latex in rubber trees, and to drive allometric equations for other properties:

$$T_Targ etLeafTwig = T_LeafTwigDiam \mid T_StemDiam^{T_LeafTwigDiamSlope} \quad [56]$$

$$T_BiomBranch = T_BranchDiam \mid T_StemDiam^{T_BranchDiamSlope} \quad [57]$$

$$T_Larg eWood = T_Wood - T_BiomBranch \quad [58]$$

If the $T_ApplyFBARules?$ switch is on (value = 1), the transfer of dry weight and nutrient resources from the canopy biomass to the T_Wood pool is driven by the difference between $T_TargetLeafTwig$ and current $T_CanBiom$.

3.8.5 Tree Phenology

In WaNuLCAS up to version 2.1 we treat the physiological water use efficiency (dry matter production per unit water used, in situations without nutrient stress) as a constant, to be specified for each crop type or tree species, but not varying with plant age. The model predicts that this water use efficiency will be reduced under nutrient stress, as such a stress (beyond a tolerance limit) affects dry matter production but not water use. The main differentiation in physiological water use efficiency implemented so far is a generic difference between C3 and C4 crops.

Measurements of instantaneous water use efficiency at leaf level, e.g. with IRGA equipment, generally show considerable variation in this

efficiency between individual leaves, partly linked to position of leaves in the canopy and leaf age. During 'ageing' leaves tend to become less efficient for a number of reasons. Where trees differ substantially in average age of current leaves (e.g. in a comparison between trees that are evergreen and those that regularly shed leaves in a dry or cold season) a difference in 'average leaf' water use efficiency should be expected. One step further would be to keep track of the average age of current leaves in a canopy and assign a water use efficiency on the basis of a generic 'ageing' function.

In calculating the average age of a leaves in a canopy we may simply impose a phenological pattern on a tree based on the time of year that leaf flush starts and litterfall is completed (either the same dates every year, or differentiated according to weather records and e.g. a temperature sum), or trigger these events by relations inside the model (Fig. 3.26). Since WaNuLCAS version 2.1 rules are included for a drought-induced litterfall, with a minimum waiting period for leaf re-emergence if the water stress disappears (e.g. as a consequence of reduced demand after litterfall...).

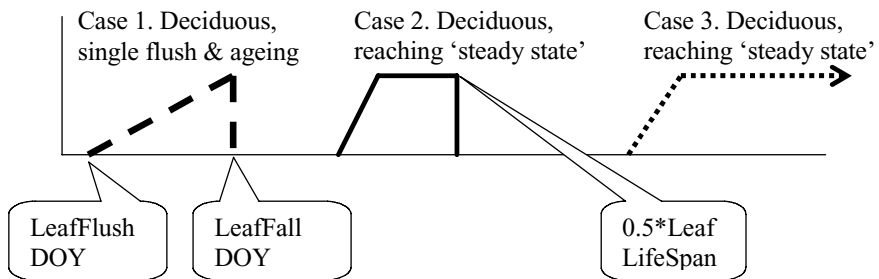

Figure 3.26. Three parameters are used to describe the leaf age over time, allowing the 3 cases to be parameterized

3.8.6 Cumulative litter fall

If the initial length of a link (section of stem or branch between two branching points) is L_{min} , and its initial diameter D_{min} , a linear increase of expected link length with diameter can be described as:

$$L(D) = L_{min} + a_1(D - D_{min}) \quad [59]$$

If we may assume that the distance between branching points does not vary with time or growth stage of the tree, an increase in distance reflects

branches being dropped. If $L(D) = 2 L_{min}$ one branch will have dropped, for $L(D) = 3 L_{min}$ two branches etc.; from equation [51] we can expect that for a diameter increment from D_x to D_{x+} an additional number of branches of a_l / L_{min} will be dropped (ignoring the discrete character of these events and describing their expected means for a population of branches). We may assume that the branch dropped was the smaller one of the two branches at that branching point, so it had a diameter of:

$$D_{x2} = \left((1-q) D_x^2 / \alpha \right)^{0.5} \quad [60]$$

where a and q are parameters of the fractal branching process.

The biomass of the dropped branches can be estimated from the overall biomass equation $Biom = BiomD1 D^b$ and the total biomass dropped can now be derived by integrating from $D = D_{min}$ to $D = D_{max}$:

$$\begin{aligned} CumLittfall(D0) &= \int_{D_{min}}^{D_{max}} (a_l / L_{min}) BiomD1 \left\{ \sqrt{(1-q) D^2 / \alpha} \right\} dD = \\ &= \frac{a_l BiomD1 \left((1-q) / \alpha \right)^{0.5b}}{L_{min} (b+1)} \left(D_{max}^{b+1} - D_{min}^{b+1} \right) \end{aligned} \quad [61]$$

For any D_{max} value more than $2.4 D_{min}$ the error made when ignoring the D_{min} term in the equation is ignored is less than 5% and for $D_{max} > 3.7 D_{min}$ it is less than 1%. For cumulative litter fall based on dropped branches with the leaves they originally carried, we thus derive an approximate allometric equation with power $b+1$, if the D_{min} term can be ignored. As the power of the cumulative litterfall equation is higher than that for standing biomass, cumulative litterfall will exceed standing biomass beyond a certain stem diameter (Fig. 3.27A); the position of the cross-over point is (again, if the D_{min} term can be ignored):

$$D = \frac{L_{min} (b+1)}{a_l \left((1-q) / \alpha \right)^{0.5b}} \quad [62]$$

and is this independent of $BiomD1$ and decreases with increasing slope of the link length diameter relationship a_l (if $a_l = 0$ there is no litterfall).

From equation [54] we can derive the current litterfall for a small diameter increment above D_0 as:

$$AllocLit(D) = \frac{dCumLittFall}{dD} = \frac{a_l BiomD1 \left((1-q) / \alpha \right)^{0.5b}}{L_{min}} \quad [63]$$

while allocation to the Biomass pool will be:

$$AllocBiom(D) = \frac{dBiom}{dD} = bBiomD^{-1} D^{b-1} \quad [64]$$

Thus, the relative allocation of new photosynthate to litterfall will increase with D0 according to:

The relative allocation to litterfall thus approaches 1, posing a limit to the maximum size of a tree (Fig. 3.18 B).

$$RelLitFallAlloc(D) = \frac{a_l \left((1-q)/\alpha \right)^{0.5b} D}{a_l \left((1-q)/\alpha \right)^{0.5b} D + bL_{min}} \quad [65]$$

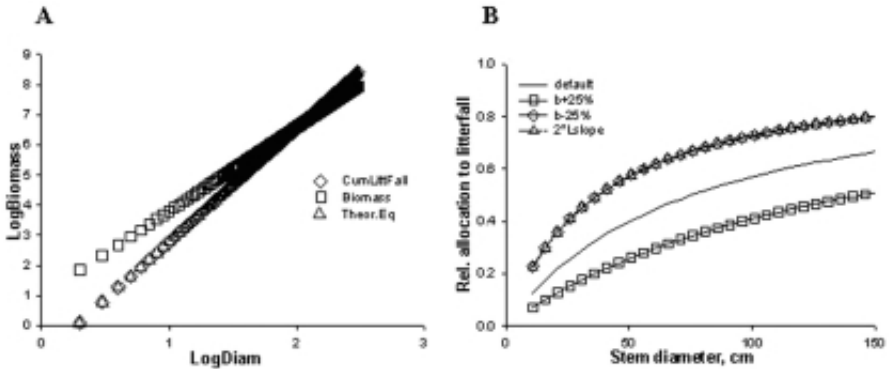

Figure 3.27. A. Comparison of biomass and cumulative litterfall as a function of stem diameter comparing a numerical integration with results of eq.[54]; B. Relative allocation of current biomass production to litterfall as a function of stem diameter for a default parameter set and in situations where the slope of the biomass allometric equation is increased or decreased by 25%

In the actual implementation of litterfall according to these allometric rules, we take into account that actual litterfall e.g. due to drought stress, can be ahead of the amount due according to equation [54]. If so, new leaves and twigs can grow unimpeded until the former canopy biomass is regained.

3.8.6 Tree products

A number of tree products can be harvested and removed from the plot:

- tree prunings (e.g. for use as fodder), governed by T_PrunHarvestFrac
- fruits, governed by d T_FruitHarvIndex, fruiting itself governed by tree stage (see Tree Growth Stage)

- latex, coming directly from the T_GroRes pool; the model user can define a minimum tree diameter required for tapping and the fraction of growth resources harvested on a tapping day
- wood, governed by T_WoodHarvestFrac and T_WoodHarvDay

3.8.7 Oil Palm Growth

A new option is available to simulate fruiting mechanism in oil-palm (Fig. 3.28).

Palms differ from most dicotyledonous trees in a number of ways that are relevant for the current model: they have a much more rigid development pattern in which leaves are formed and emerge continuously (rather than with the seasonality or flushing of many trees), gradually forming a stem which normally does not branch and that does not show secondary growth in diameter (as the leaf area supported by the stem is virtually constant over time there is no need for more transport or support tissue, but inversely, the lack of secondary meristems in the existing stem can be a constraint on branch development). Flowers are formed in axillary buds, one for every leaf and have a long development trajectory that starts much before the adjacent leaf emerges, and that includes phases where the sex of the flowers is determined, in response to physiological conditions in the palm. The long development phases from bud to flower to ripe fruit causes a large number of developing bunches to be present on the same palm, interacting in their demand for growth resources.

This general pattern applies to oil palm, coconut, peach palm and date palm. For the sago and sugar palm, however, flower development is delayed and the palm stores large amounts of internal resources; in sago these are directly harvested (and the palms lose all their value in years that the climate-related trigger for flowering is expressed), for sugar palm the stored resources are intercepted on their way to the developing flowers, once the palm starts to flower (and flowers develop in a top-down sequence, opposite to their age).

Focussing on oil palm and leaving further model adaptations to other palms for a later treatment, the following model elements were identified for the model:

- ***phyllochron*** time keeping: the time interval between the emergence of two leaves, or phyllochron, determines the basic unit of time for floral and fruit development as well. For current oil palm germplasm a phyllochron unit is about 14 days.

- **sex determination** of flowers is related to the internal condition of the palm, based on its internal growth reserves, as well as in response to current water stress; as in the model the switch between male and female bunches is set at a single day, we do it on the basis of a moving average of the past water stress levels; because of the link with internal growth reserves the module can account for the tendency to male flowers caused by tapping for palm wine, as is common practice in W. Africa.
- **simultaneous development and resource competition** between the various male and female flowers and bunches present at any point in time, with an age-dependent relative sink strength,
- **abortion** of individual fruits in a bunch, in response to water stress,
- **book keeping** of the dry weight and fruit number individual bunches as they shift through the stages from flower to ripe bunches,
- **harvest of one (potential) bunch at the end of each phyllochron unit.**

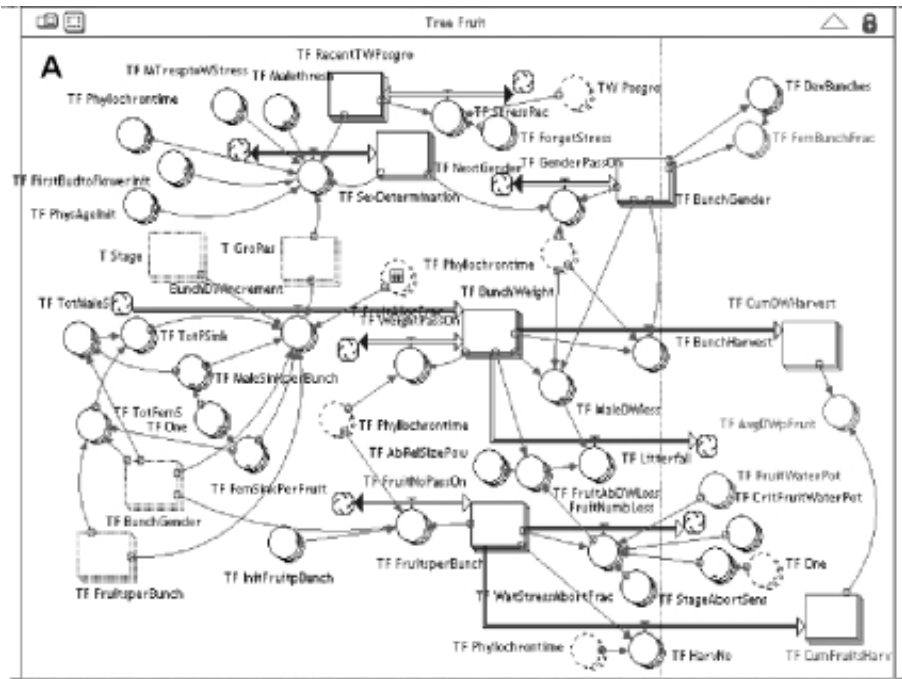

Figure 3.28. shows the palm oil module in WaNuLICAS, sink strength for male and female bunches and the sensitivity to drought stress leading to fruit abortion depend on bunch development stage.

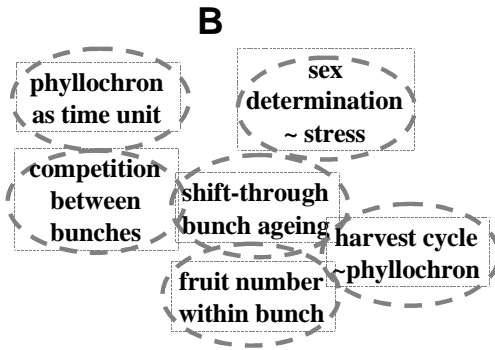

Figure 3.29. Diagram (A) and schematic map (B) of the new tree fruit module developed to represent palm fruit development in the various bunch stages

3.9 Carbon Balance

3.9.1 Soil organic matter

Total soil organic matter is supposed to consist of 'metabolic' and 'structural' pools in the recently added organic materials, an 'active' (= microbial biomass), 'slow' and 'passive' pool. This terminology is derived from the Century model (Fig. 3.30). This part of the model was developed in discussions with Dr. Georg Cadisch (Wye College, UK) and Dr. Andy Whitmore (AB-DLO, the Netherlands).

In agro-ecosystems without soil tillage, a distinct litter layer develops where much of the organic inputs decompose with little contact with the mineral soil layers. The dynamics of C and N here can differ substantially from that in the soil layers, as the 'physical protection' mechanisms based on soil texture are absent, and temperature and water dynamics differ. Incorporation of surface litter into the soil can be the result of specific groups of the soil fauna, as well as of mechanical tillage operations. Starting from version 2, WaNuLCAS therefore represents the C, N & P pool dynamics for the litter layer separate from SOM dynamics, using the Century pool descriptions for both (all parameter names MC_{...} and MN_{...} refer to the litter layer, names MC2_{...} and MN2_{...} to the SOM pools). The texture, water and (potentially) temperature controls differ between these layers. For N immobilisation the litter layer has limited access to soil layer 1, while all mineralization products are delivered to layer 1. For the SOM pools, a weighted averaged is made of layer 1...4 for all its relations with soil water and N pools (including immobilization and mineralization). The weighing factors for the soil layers are set at the start of the model (but can be made dynamic if one wants).

An option is introduced to initialize on the basis of the Corg/Cref ratio, where Cref is either derived from a pedotransfer function (Type = 2) or specified by the model user (Type = 3). The relative allocation of Corg to the slow, active and passive pool is driven by the Corg/Cref ratio for Types 2 and 3.

1. for MC_SOMInitType = 1 the user can specify all pool sizes for all zones,
2. for MC_SOMInitType = 2 the user can specify the size of all pools relative to those for a forest soil (Cref) that is calculated from soil texture data,
3. for MC_SOMInitType = 3 the user specifies the Corg and Cref directly, but otherwise follows the procedure of Type 2

Input streams of organic matter from crop residues, tree litterfall, prunings and/or external organic sources supply 'metabolic' and 'structural' pools, by adding all C, N, lignin and polyphenolic contents of all inputs on a given day. Century's distribution equation is then applied to allocate these streams to metabolic and structural litter pools. This represents a 'simple mixing' algorithm, without specific interactions between residues.

Before the Century equations are applied, however, the total polyphenolic content is supposed to immobilize N from the current organic inputs and (if necessary) soil Nmin pool, into the 'slow' pool of C and N. This equation can account for some of the non-linear effects when residues with low and high polyphenolic content are mixed.

Immobilization of mineral N can occur where metabolic and especially structural SOM pools are utilized by microbial biomass to make 'active SOM', with a low C/N ratio and (for structural litter) 'slow SOM'. Modifications were made here to the model (if we understand what the Century handles this situation). The flow of C is driven by the preceding C pool size and the relevant decomposition parameter k. This C flow induces a parallel N flow on the basis of the C/N ratio of the preceding and subsequent SOM pool.

If there is sufficient Nmin in the soil layer, this will be used to meet the 'target' C/N ratio of the subsequent pool. If there is not enough mineral N, however, to (fully) meet this demand the C/N ratio of the subsequent pool will increase. This will have two effects:

1. further transformations of SOM will slow down, and reach a halt where the microbial biomass has a CN ratio of 1.75 times the 'target' value. The value 1.75 was suggested by Dr. Georg Cadisch.

- the SOM pools remain 'hungry' for mineral N and will re-stock their N content to meet the 'target' whenever mineral N becomes available in the soil again.

These modifications to the Century model are mainly relevant at relatively small time scales (less than the yearly time steps for which Century was designed). The model can now potentially account for the rapid disappearance of mineral N into the soil after fertilizer N additions, while such fertilizer may become available to subsequent crops.

Apart from the freedom to set parameters, a number of options on model structure was built into WaNuLCAS:

The k values driving the SOM-C and SOM-N transformations are a function of clay content and soil temperature as in the Century model, and an additional reduction based on soil water content. For example, for the active pool the k value is calculated as:

$$k = 0.14 * (1 - .75 * Mc_SiltClay) * Mc_TempLim * Mc_TethaLim [Zone] \quad [66]$$

where the 0.14 and 0.75 are the parameter values for the active pool (other pools use different values but the same reduction factors). Make sure that the value of silt and clay content used should be consistent with the value used in deriving soil hydraulic properties.

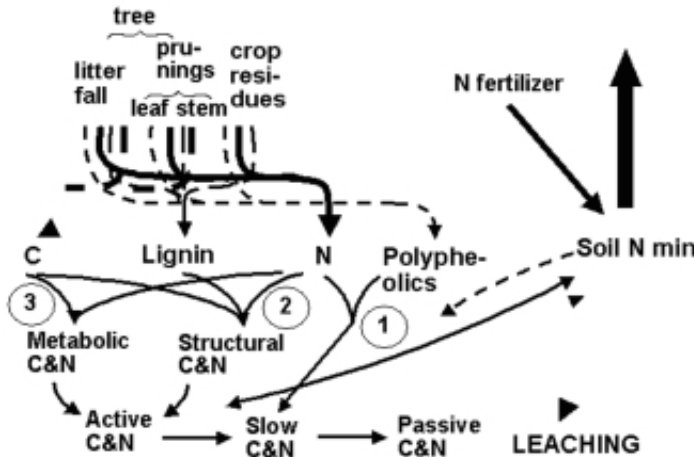

Figure 3.30. Major relationships in N immobilization and N mineralization from organic residues; the basic C and N pools are similar to the Century model, but plant polyphenolics are added as litter quality parameter

3.9.2 Carbon stocks

An output table is provided which summarizes the carbon balance, similar to the water, nitrogen and phosphorus balance sheets.

On the left hand side it includes all initial carbon stocks in soil, crop and tree (with plant biomass converted into carbon units) and all net daily photosynthesis by crop and tree. On the right hand side it lists all final carbon stocks in soil, crop and tree, all carbon in products removed from the plot and all carbon lost as CO₂ in soil organic matter transformations. Plant respiration is implicit in the net photosynthesis and thus does not appear on the C balance sheet.

3.10 Management options

3.10.1 Options for strategic and tactic management

The WaNuLCAS model can evaluate a number of farmer management options. These can be grouped in strategic decisions, to be made by a farmer before crops are planted and by a modeler at the start of a simulation and tactic management during a growing season, in response to actual crop performance.

Strategic options include

- Plot size and tree spacing,
- Choice of tree species as reflected in their functional parameters of canopy shape and branch allocation, root distribution under given soil conditions),
- Cropping cycle: crop types and planting dates.
- Predetermined pruning events
- Pre-determined tree final harvest and/or tree mortality
- Slash-and-burn events, including options to remove part of the wood before the burn,
- Building a fence around the plot

Tactical options represented in the model are:

- Tree pruning based on current tree and crop status,
- Use of fertilizer and organic inputs and their distribution over the zones,
- Crop residue removal,
- Maintaining the fence.

At this stage only two types of plants are considered and thus we imply that there are no weeds. The equations for resource sharing and competition are set up in such a way that the model can be extended to an n-plant interaction and different plants can share a zone in the model, above as well as belowground.

3.10.2 Slash-and-burn events

A number of 'Slash' events can be defined in the event calendar, by specifying the S&B_SlashYear and S&B_SlashDOY tables. Slash events transfer all current aboveground biomass in tree, weed or crop pools to the S&B_Necromass pool. This refers to the dryweight, N and P contents of these pools. From the S&B_Necromass a fraction can be transferred daily to the surface litter pool, as set by the S&B_DailyNecromLittTransf parameter, where it will follow century-model based transformations of C, N and P pools. The S&B_Necromass pool will intercept part of any rainfall events, replacing the role played previously by tree and crop biomass, and the subsequent evaporation from the 'Rain_CanopyWater' pool will determine the moisture content of the necromass. When this is below a set value ('S&B_CritWatContent') the switch 'S&B_IsSlashDry?' will be turned on, allowing burn events to take place, otherwise it is turned off.

Burn events are defined by specifying a minimum and maximum number of days after the most recent 'slash' event. A fire event will be implemented on the first day in this period that the signal 'S&B_IsSlashDry?' is on. During a burn event, the temperature increase at the soil surface is calculated from the necromass + structural part of surface litter, with corrections for their respective moisture contents based on 'Rain_CanopyWater' and 'W_Theta1[Zone]'. Temperature calculations need two parameters: 'S&B_FuelLoadFactor' and 'S&B_TempWetnessCorr'. The temperature increase in the topsoil is derived from the temperature increase at the soil surface, modified by soil water content of the topsoil.

Burn events can have impacts on a number of pools in the model, either via the temperature at the soil surface or that in the top soil:

- reduction of surface necromass, surface litter and SOM pools, by S&B_NecromassBurnFrac, S&B_SurfLitBurnFrac and S&B_SOMBurnFrac, respectively,
- allocating all C of the burnt necromass to CO₂, and 1 - S&B_NutVolatFrac of its N and P content to mineral nutrients at the soil surface,

- induce a (one-off) transfer from the immobile P fraction in the topsoil via S&B_FirIndPMobiliz
- induce a semi-permanent relative change of the effective P sorption via S&B_FirImpPSorption; a gradual return to the original P sorption value will be governed by S&B_PsorpRecFrac
- release cations into the topsoil from burnt necromass, leading to an increase of topsoil pH; this change of pH will modify the P sorption properties as well, with the overall effect obtained by multiplying the two factors,
- evaporate all soil water from the topsoil if the temperature exceeds 100oC via S&B_FireWEvap
- modify soil water retention properties via S&B_FireImpactonWatRet, with a gradual return to the original values governed by S&B_WatRetRecFrac.
- induce tree mortality switch S&B_FireTreeMort? if the temperature exceeds the S&B_TreeTempTol[tree]
- induce mortality in the weed seed bank via S&B_FireMortSeedBank

Most of the above impacts is related to temperature via a graphical input; impacts can be set to zero by modifying these graphs.

3.10.3 Tree mortality

Trees can die due to fire (see 3.10.2) or at a set date (T_KillYear and T_KillDOY). Currently, we can kill, replant then kill of any tree on a certain zone up to 3 times on 1 length of simulation.

If Rt_ATType = 2 is used, any remaining root biomass at that time is treated as input to the soil organic matter module.

3.10.4 Weed growth

An option is provided to include weed growth in the simulations, outside of the cropping periods. If the switch C_SimulateWeeds? is set at 1 (instead of 0), weeds will start growing whenever crops are absent, based on a fraction C_WeedGermFrac of the current seedbank of live weed seeds. The seed bank (dry weight) is initialized at C_WeedSeedBankInit kg m² for all zones, with nutrient contents based on C_SeedConc. Daily influx of weed seeds from outside of the plot equals C_WeedExtInflux, while a fraction C_DailyWeedSeedDecay is transferred to the litter layer. During fire, additional decay of viable seeds will be accounted for, depending on the temperature on the topsoil.

Growth of the weed biomass follows the rules for crop growth, with a parameter set chosen on the basis of Cq_WeedType (default = 10). The weed can have a perennial or annual growth habit, depending on the value of Cq_SingleCycle? for crop type 10.

3.10.5 Pests and diseases

Leaves, roots, fruits and wood of crops and trees can be eaten by herbivores, rhizovores, frugivores and lignivores, respectively. The user can define a constant daily fraction to be removed from each plant organ types by such events. This is a skeleton on which the user can build, e.g. by making the impacts dependent on crop stage and/or the amount of alternative food for the organisms involved. A simple version of a pest population dynamics module is included, that allows pest organisms (nasties) to enter the plot from the surroundings of the simulated area. A fence can be build around the plot and the various categories of pest can either jump the fence or be deterred by the fence if it is in a good enough condition ($PD_FenceQ \geq 1$). Again, this is a skeleton of a module only, and the user who is interested in this type of interactions and lateral flows will have to provide more detail.

3.10.6 Fence

Fence quality is supposed to be related to initial labour time investment according to $Q = M * L / (K + L)$, where M is the maximum quality (PD_FenceFullQuality) and K the amount of labour to reach half of this maximum (PD_HalfFenceTime). To calculate the change in fence quality due to subsequent labour investment, we can first express the current condition in an equivalent time ($t = K Q / (M - Q)$) and then calculate the new quality based on this time t plus the new labour time investment. The change in fence quality due to a new time investment Lcurr becomes:

$$\Delta FenceQuality = Lcurr(M - Q)^2 / (KM + Lcurr(M - Q)) \quad [67]$$

In WaNuLCAS two options are provided for fence building and maintenance: if PD_FenceMaint? = 1 a certain amount of labour is spent (PD_FenceMUnit * PD_HalfFenceTime) whenever there is a crop on the field (in any of the zones) and the current quality of the fence is below the threshold (PD_FenceQThresh. If PD_FenceMaint? = 0, fence building responds to a calendar of events specified by PDFeceBuildY, PD_FenceBuildDOY and PD_FenceBuildLabSeq (the latter in units relative to PD_HalfFenceTime).

Fence quality decays by a fraction PD_FenceDecK per day. Costs for fence building and maintenance are taken to be proportional to the amount of labour spent, and the P_FenceMatCost[PriceType] value is supposed to be spent when the amount of labour used equals PD_HalfFenceTime.

3.10.7 Tree pruning

For tree pruning the following options are provided:

T_PrunY and **T_PrunDoY** allow the user to specify pruning dates, similar to the cropping calendar. This option may be especially useful if simulations are to be compared to actual data sets. If the user does not want this type of pruning events, the T_PrunY for the first event should be after the simulation run ends.

T_PrunPlant? Determines whether or not the tree will be pruned every time a new crop is planted (0 = not, 1 = yes)

T_PrunLimit specifies a critical total LAI of tree canopy above which trees will be pruned, if and only if there is a crop in one of the zones

T_PrunStageLimit will ensure that no tree pruning is implemented in the later part of the crop (after this stage in crop development), to avoid tree pruning just before crop harvest.

For each pruning event, the parameter **T_PrunFrac** specifies the fraction of tree canopy biomass removed. This can be specified as constant for every pruning event or changes for every event.

T_PrunHarvFrac specifies the fraction of prunings that is removed (harvested) from the field, e.g. for use as fodder. This can also be specified as constant or dynamic.

3.10.8 Tillage

This option relates to Soil Erosion and transfer of litter to SOM pools. Tilling can be specified from a calendar, or be automatically implemented at X days before planting a new crop.

3.10.9. Timber Harvesting

Timber can be harvested, specified either by calendar (T_HarvY and T_HarvDOY) in Excel sheet Tree Management or by tree diameter in Stella file. When timber is harvested all canopy biomass and fruit are removed

from plot. T_WoodHeight will decreased depending on fraction of timber removed.

3.10.10 Grazing

Grazing will affect crop/grass only and 2 types of grazing pressure can occur, field and patch level.

Field-level grazing pressure depends on two factors:

1. stocking rate in standard livestock units as a function of simulation time.
2. daily intake requirement per animal.

Patch-level grazing pressure depends on field-level grazing pressure, relative attractiveness of grass/crop in the patch and total fodder availability in the field. Relative attractiveness of grass is a function of standing biomass, N concentration and growth stage

Input parameters related to this module are:

1. Graphical inputs specifying the attractiveness on the basis of biomass (G_BiomDep), N concentration (G_Ndep) and growth stage of the grass (G_StageDep).
2. A graphical input defining the stocking rate as a function of time (G_StockrateperHa)
3. Daily requirement per standard livestock unit=SLU (G_DayDempDayKg, default value 2.5% per dry weight SLU)
4. Standard live stock unit (G_SLU, default value 450 kg)

The possible output are cumulative biomass grazed, G_GrazedBiomCum (in dry weight) and its nutrient content).

For future modifications, we plan to have rule for relating stocking rate to standing biomass as result of actual grazing success. This would reflect farmer decision making in managing the system.

3.11 Model output

3.11.1 General

A number of graphs and tables is provided for viewing output of a WaNuLCAS simulation, but the Stella environment allows a user to interrogate the model for the value of any parameter at any time step desired.

On the 'Output menu' one has a choice between viewing graphs of biomass and elements of water and nutrient balance for the system as a whole, or specific by zone. An overview of the balance of inputs and outputs is given for N, P, C, water and money. The 'yields' screen translates the dry weights of the model to the moisture contents conventionally used for agronomic yields (as governed by the .C_AgronYMoistFrac parameter in crop type).

3.11.2 Financial analysis

The WaNuLCAS model can predict the outcome of patch-level performance of agroforestry systems under a range of management choices. In version 2 a simple financial analysis is provided in the form of a Net Present Value calculation. Dr. Thomas P. Tomich and Mr. Suseno Budidarsono (ICRAF SE Asia) advised on the development of this section. The basic equation is:

$$NPV = \sum \frac{-cost + return}{\{1 + DiscountRate / 365\}^{time}} \quad [68]$$

Two types of prices can be used simultaneously, social and private, so as to allow an analysis of the impacts of economic policies and market imperfections on the profitability of the agroforestry system simulated. As we do a daily accounting of costs and returns, no separate category of 'working capital' is needed as one would use for an annual accounting system. Costs and returns included in WaNuLCAS 2.0 are listed in Table 3.7.

Table 3.7 Costs and returns included in the calculation of net present value in WaNuLCAS 2.0

Costs	Returns
Planting material for crop and tree	Harvested crop yields
N and P fertilizer or pesticides used	Harvested tree products (wood, fruit, latex, prunings used as fodder)
Organic inputs	
Labour for tree planting, management and harvesting	
Labour for crop planting, management and harvesting	
Labour and input costs for field protection (incl. fence building and maintenance)	

3.11.3 Filter functions

Tree and crop roots can exert 'safety-net' or 'filter' functions by intercepting nutrients from various depths of the soil, and thus preventing them from losses by vertical leaching or horizontal lateral flow (Fig. 3.31). The ratio of uptake to (uptake + loss) can be used to indicate the local filter function (Cadisch *et al.* 1997, Rowe *et al.*, 1999):

$$N_LocFF_{ij}[Nutrient] = Upt_{ij}[Nut]/(Upt_{ij}[Nut] + Loss_{ij}[Nut]). \quad [69]$$

$$N_LocFF_{ij}[Nutrient] = Upt_{ij}[Nut]/(Upt_{ij}[Nut] + Loss_{ij}[Nut]). \quad [70]$$

$$N_TotFF[Nut] = TotUpt[Nut]/(TotUpt[Nut] + TotLoss[Nut]) \quad [71]$$

where the TotLoss is accounted for at the boundary of the system, ignoring internal transfers within the system. The total filter function by this definition is not equal to the sum (or average) of the local filter functions, as the divisors of the ratio differ. The total filter efficiency can, however, be split into the contributions of each cell:

$$N_TotFF[Nut] = \sum_i \sum_j N_LocFF_{ij}[Nut] = \sum_i \sum_j Upt_{ij}[Nut]/(Upt_{Tot}[Nut] + Loss_{Tot}[Nut]) \quad [72]$$

The N_TotFF_{ij} values can be added up to obtain the total filter function of a certain layer or column. Of particular interest may be the filter function of the bottom layer and that of the lowermost column.

A third type of filter function can be defined for the 'edge' of the system., i.e. layer 4 + zone 1 (but avoiding a double count of cell 1.4):

$$N_EdgeFF[Nut] = \sum_{k=edge} Upt_{Edge_k}[Nut]/(Upt_{TotEdge}[Nut] + Loss_{TotEdge}[Nut]) \quad [73]$$

This edge filter function can be partitioned in a horizontal (zone 1) $N_EdgeFFH[Nut]$ and vertical (layer 4) $N_EdgeFFV[Nut]$ component, by sharing the uptake from cell 1.4 over the two in proportion to the cumulative loss in horizontal and vertical direction from this cell.

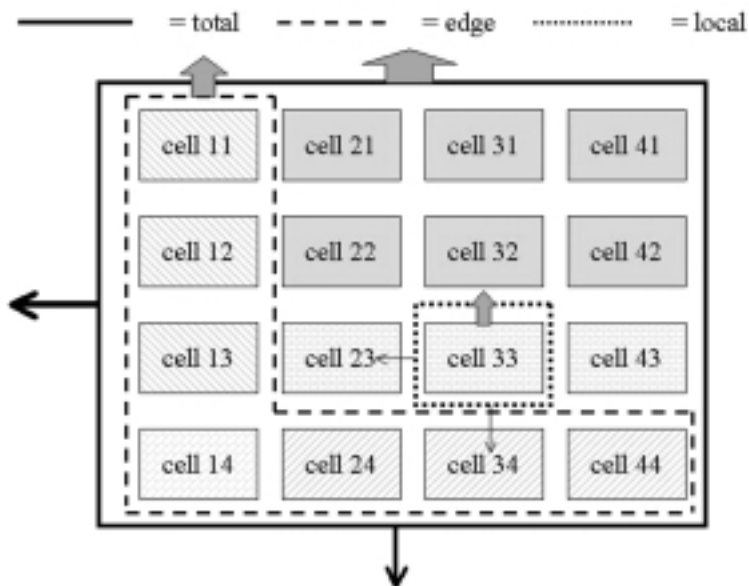

Figure 3.31. Filter functions (or safetynet functions) are defined as uptake/(uptake +loss) at three scales: local (as example here for cell 3.3), edge (uptake from zone1+layer4, net losses from the edge equal net losses from system as a whole) or system as a whole

3.11.4. Number of days plants has growth limitation

We defined this as fraction of days (out of the length of simulation days) tree or crop is limited by water, nitrogen or phosphorous.

Chapter 4

Examples of model applications

We first explore a simulation based on the 'default' parameters of version 3.0 and see how crops, trees and weeds interact and compete for N, P, water and light on soil rich in organic matter but with limited rooting depth due to subsoil acidity.

After that, five examples of model applications (made with version 3.0) are presented, to test the objective that the model can be applied to a wide range of agroforestry research questions.

Results are not compared to specific data sets and no parameter fitting has occurred. Examples are presented for simulation runs of a simple soil-crop system at different N fertilizer regimes, hedgerow intercropping systems at different hedgerow spacing and pruning regime, a test of the safety net function of deep tree roots, lateral interactions in crop-fallow mosaics and a first exploration for parkland systems with a circular geometry across a rainfall gradient and some more examples of WaNuLCAS application on the agroforestry research.

In each example, a list of input parameter changes is provided. These changes are relative to default values. If you have made recent changes in WaNuLCAS.stm and would like to return to default values for a group of parameters, click on undo button (U) at the top of list input device. If you want to reset all parameters to their default values, you can use a "Return to DEFAULT value" button in the "Input" section.

4.1 Simulation based on default parameter settings

For a start, the default parameter settings can be used to become familiar with the various types of model output that can be obtained. The default settings simulate an alley cropping system of maize and *Peltophorum dasyrrachis*. Figure 4.1 gives the biomass production results for a 'default' run of 2 years duration in which the trees are always pruned before planting a new crop. In the first cropping period there is little difference in crop growth between the three zones. In the first cropping season of year two, crop growth starts to differ significantly between zones and the crop in zone 2 (close to the hedgerow) produces less biomass compared to zones 3 and 4, as it faces more competition in terms of water, nutrient and light. During fallow period the hedgerow trees start develop more biomass until the next cropping season when the hedgerows are pruned; the woody part of the hedgerows is maintained, so overall aboveground tree biomass can gradually reach a higher level.

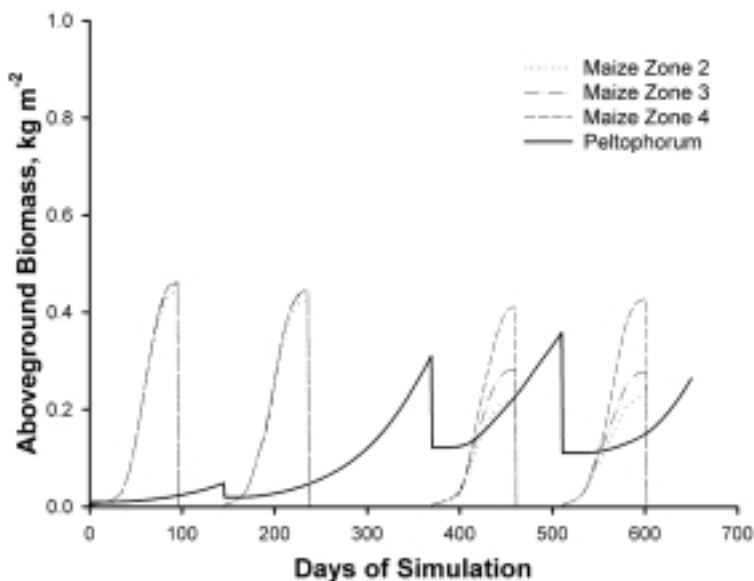

Figure 4.1 Biomass development of crop and tree for a WaNuLCAS 3.0 simulation using 'default' parameter settings

If you click on 'To View Water Input Output Summary' you will see results of the water balance. The only inputs of water were due to rainfall directly on the simulated area, as the default slope of 0% stops any Run-On or Lateral Inflow (but not the option of Run-Off). Out of a cumulative rainfall of 5812 mm (i.e. 2606 mm year⁻¹), 79 mm was used to recharge the soil (which

was initialised below field capacity), 3723 mm drained from the soil profile, 174 mm became surface run-off, 636 mm evaporated from the soil surface, 146 mm evaporated from interception by crop and tree canopy, 731 mm was transpired by the crop and 324 mm by the tree. The BW_NetBal result of $4.5 \cdot 10^{-13}$ indicates that the error in accounting for all inputs and outputs of water is negligible.

The N balance shows that there has been a considerable net mineralization of N during the simulation, with the SOM_N pools decreasing from 247 to 227 g m⁻². Neither crop nor tree fixed atmospheric N₂ and no N fertilizer was applied. The stock of mineral N has increased from 1.1 to 1.65 g m⁻², while 9.5 g m⁻² was lost through leaching and 7.6 g m⁻² was exported with crop harvest products. At the end of the run N the tree biomass was 2.2 g m⁻² and the error term of the N balance was $-5.68 \cdot 10^{-14}$.

In the P balance we again see that mineralization of organic P has been the major supply of P to the crop and tree, with the organic P stock decreasing from 57 to 55 g m⁻². In contrast to N, however, leaching losses have been very small (0.14 g m⁻²). The error term of $-1.8 \cdot 10^{-13}$ again indicates that there are no problems of consistency.

The 'Filter Function' output sector indicates that overall the agroforestry system has been quite effective in capturing the N and P released from the soil organic matter before it leached out of the profile, with an overall filter efficiency of 67 and 98% for N and P, respectively. A substantial part of this overall filter function was located in the 'Edge': filter function horizontally was 17 and 73% for N and P, respectively; filter function vertically was 7 and 2% for N and P, respectively. The local filter efficiency in layer 3 (relative to leaching and lateral flow losses from each cell) clearly decreased from zone 2 to zone 4, with decreasing root length density of the tree. The overall filter functions are higher for P than they are for N as the lower mobility of P (relative to N) retards the leaching and increases the P residence time, giving more opportunity for uptake; this effect apparently exceeds the impacts on uptake of a larger diffusive resistance.

The C balance shows again the decrease in soil C during the simulation (2679 to 2438 g m⁻² or 27 to 24 Mg ha⁻¹), while total photosynthesis of the tree is more than half of that by the crop (319 and 536 g m⁻², respectively), most of which was lost in respiration. At the end of the two years simulation, 335 g m⁻² has been exported from the field in crop products, while the current tree biomass is 111 g m⁻². The error term of the C balance is negligibly small at 0, while the 'time-averaged C stock' is 2641 g m⁻² (or 26 Mg ha⁻¹).

The 'Yields' sheet specifies the agronomic yields obtained from the system as a whole. Only the maize crops ('Type 2') are counted, as the trees did not (yet) produce any directly usable products, current tree biomass harvested comes from tree biomass pruned (8 Mg ha⁻¹). The maize grain yield of 0.94 kg m⁻² or 9.4 Mg ha⁻¹ (3.3, 3.1, 2.2 and 2.2 Mg ha⁻¹ per crop, respectively) is quite good. During the simulation N, P and water limited crop growth 37, 64 and 0 % of days in the cropping period, and tree growth for 34, 13, and 0 % of the year.

The 'light' output shows crop growth limitation by light capture. The value 0.99 means the growth of the crop was hardly limited by light.

The 'soil balance output' gives result for the amount of soil loss and current topsoil thickness. As the default value for slope 0%, topsoil thickness after two years simulation is the same to the initial value means no soil was lost during the simulation.

4.2 The use of the main switches and changes in crop or tree type

A number of ways exist to further explore the backgrounds of these results and the way limitations by water, N, P and light interact. One method is to inspect the graphs of current limitations in each zone, as provided in the 'Output' section of the model. A second method is to use the main switches on the 'Output' level and try the various combinations of 'no trees', 'no water, N or P' limitations and 'presence of weeds' for the default setting of all other parameters. Figure 4.2 A-K show the tree and crop biomass results for such runs.

Figure 4.2 A-C shows the crop biomass as a result of changing tree species and absence of the tree. The presence of the tree (comparing Fig 4.2.A-B and C) affects crop growth in zones closer to the tree. Using *Peltophorum* (comparing Fig 4.2.A and C) crop growth starts to differ between zones at year 2. Changing the tree type from *Peltophorum* to *Gliricidia* in the Excel sheet 'Tree parameters' (comparing Fig. 4.2.A and B), the impact of tree on crop growth starts earlier, that is on the second crop season of the first year. The decrease of total tree biomass during a cropping period is due to pruning and use of internal reserves in the tree. For *Gliricidia* (Fig. 4.2.B), the total tree biomass decreases during fallow period (no crop). This is due to litter fall caused by drought, as *Gliricidia* is more sensitive to drought than *Peltophorum*.

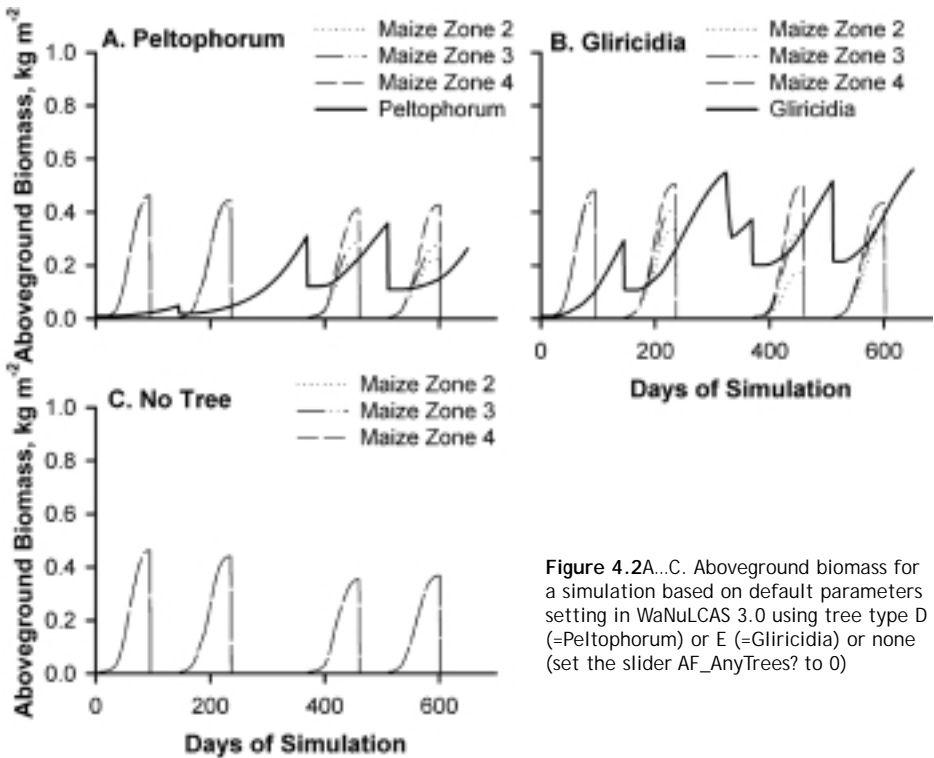

Figure 4.2A...C. Aboveground biomass for a simulation based on default parameters setting in WaNuLCAS 3.0 using tree type D (=Peltophorum) or E (=Gliricidia) or none (set the slider AF_AnyTrees? to 0)

Figure 4.2 D...G shows the tree and crop growth without water, N or P limitations. Figure 4.2 D...G indicate that removing the impacts of P limitation has by far the strong impact on overall crop growth. In its normal condition, crop growth during the second year is severely limited by P.

Figure 4.2 H...K show the impact of tree and weed presence in the systems. Current default settings are without weed and with tree. 'Weed growth' can be simulated by specifying the slider AF_SimulateWeeds? in Run and Output section to 1. To set with or without a tree situation, specify the slider AF_SimulateTrees? in Run and Output section to 1 or 0.

The pattern starts to become fairly complex, as the C_Biom output in zone 2...4 alternately refers to a crop and weed, while the weed growth in zone 1 is out of phase with the weed growth in zone 2...4. Weeds only grow during the fallow periods (no crop) in zone 2...4. In Figure 4.2.I, a tree is added to this pattern; note that the tree is not pruned when weeds occupy

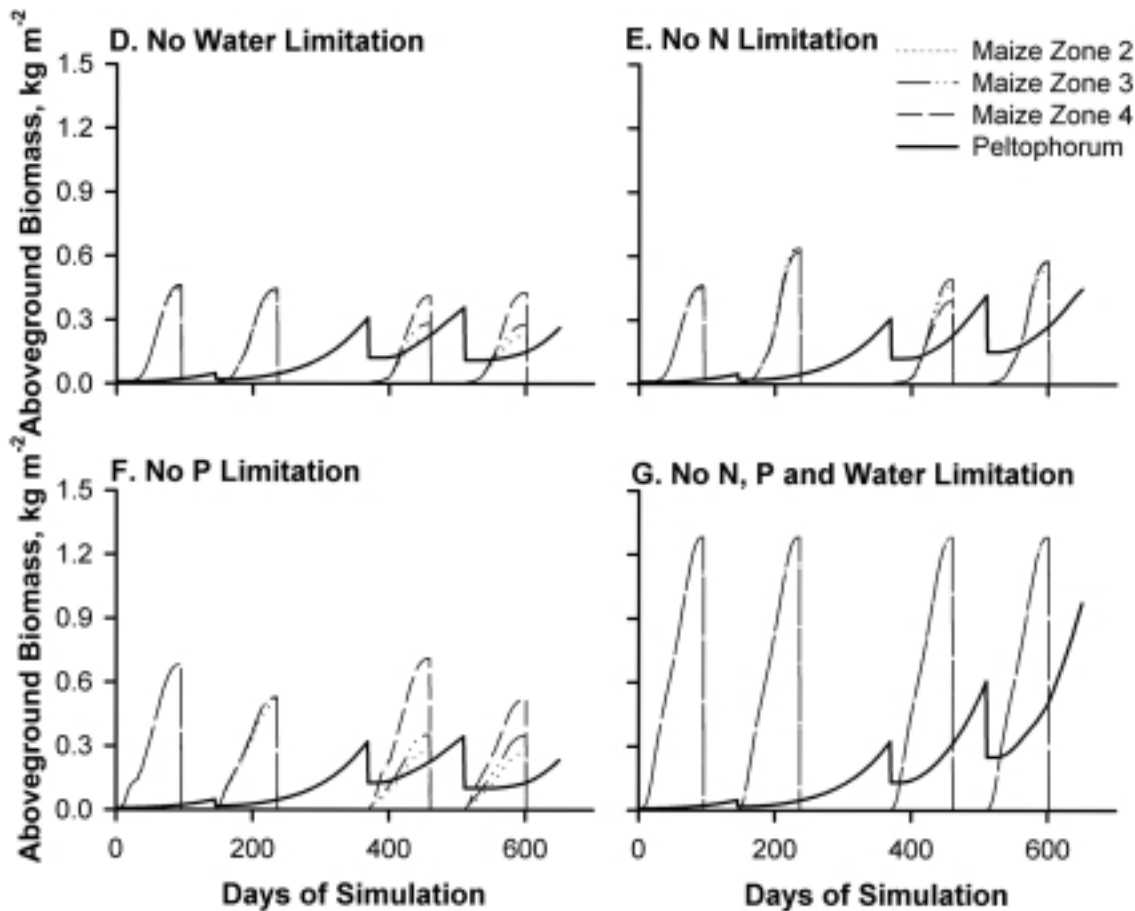

Figure 4.2.D...G. Aboveground biomass for a simulation based on default parameters setting in WaNuLCAS 3.0 as impact of N, P and water limitation

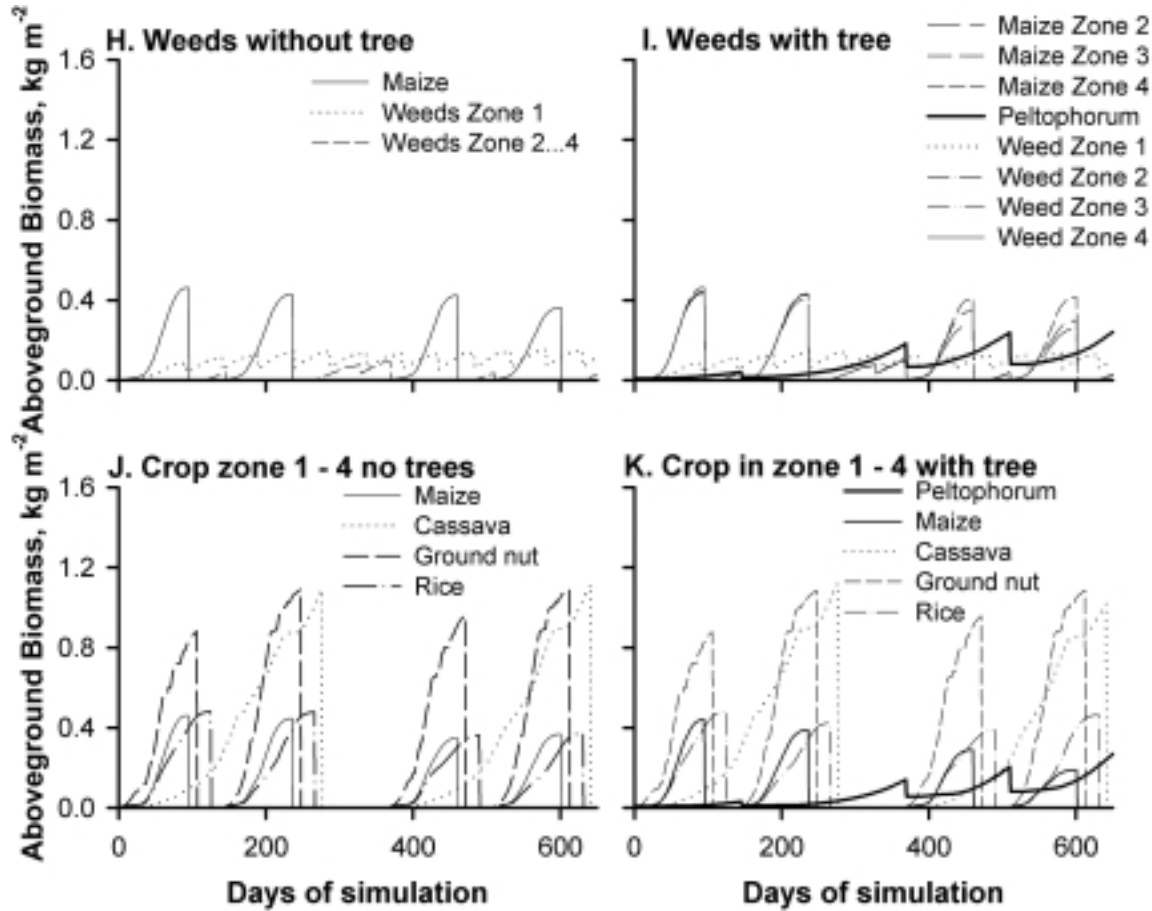

Figure 4.2.H...K. Aboveground biomass for the simple modification (less than 5 mouse clicks) of the default parameter setting in WaNuLCAS 3.0; for explanation see text

zone 2...4; the tree has some impact on weeds in zone 2, but apparently is not very effective in reducing weed growth.

Figure 4.2.J, compare the results for four crop types, each grown in separate zones and each following their own phenological cycle. To obtain this run, return to 'default' settings, set the slider AF_AnyTrees? in 'Run and Output' section to 0 and change the crop types on the 'crop management' sheet in the excel file (Maize in zone 1, Cassava in zone 2, Ground nut in zone 3 and Rice in zone 4). Note that when a tree is added to the systems (set the slider AF_AnyTrees? back to 1), as shown in Fig. 4.2.K, it will be pruned every time prior to planting crop. The presence of the tree significantly affects the biomass of maize that grows closer to the tree.

4.3 Crop-only controls with N and P fertilizer

We will normally want to compare agroforestry options with a crop only and/or tree only run for the same soil and climate. As an example we use data for maize growth in Lampung (Indonesia) as inspiration for the default case.

On flat land, in the absence of a tree, there is no interaction between the crop zones. So, we can simultaneously make runs for four N fertilizer regimes (0 in zone 1, 60 in zone 2, 90 in zone 3 and 120 in zone 4, kg N ha⁻¹), by specifying Ca_FertApply?[N] as 1. The amount of N fertilizer equals to 0, 6, 9, and 12 g m⁻² that applied twice, half at planting time and half at a month after planting time. For simplicity, we used the same amounts for P fertilizer by specifying Ca_FertApply?[P] as 1. It is applied once at planting time. Fig. 4.3 the simulation beside run at the different of fertilizer application also knows the impact of reducing 50% of soil organic matter content by reducing Mn_InitAct, Mn_InitPass and Mn_InitSlw 50% (see table 4.1 for details of changes from the default parameter setting).

The simulation (Fig. 4.3) was extended to two years, with four consecutive crops of maize. For unfertilised plots with default soil organic matter, crop biomass development started with a good initial crop biomass (with a total biomass of over nearly 0.5 kg m⁻² (= 5 Mg ha⁻¹), but the biomass declined to 20% of the first year's value in year 2. By reducing 50% of soil organic matter, crop biomass declined to 30% of default value of soil organic matter.

By applying different amount of fertilizer for N and P, the results show that the higher fertilizer, the higher crop biomass. Reducing 50% of soil

organic matters does not show significant different on the crop biomass when N and P fertilizer was applied together. Response of the reducing soil organic matter on crop biomass is obtained when only P fertilizer was applied.

Table 4.1 Input parameter modifications from default to generate example 4.3.

Parameter	New Value	Input Section (Link Location in Excel)
INPUT		
AF_AnyTrees?	0	Run and Output Section
Ca_FertOrExtOrgAppYear	0, 0, 0, 1, 1, 1, 1, 1, 1, 2, 2, 2	(Crop management/Fertilizer and organic input schedule)
Ca_FertOrExtOrgAppDoY	305, 306, 335, 81, 82, 111, 305, 306, 335, 81, 82, 111	(Crop management/Fertilizer and organic input schedule)
Ca_FertApply?[N]	1, 0, 1, 1, 0, 1, 1, 0, 1, 1, 0, 1	(Crop management/Fertilizer and organic input schedule)
Ca_FertApply?[P]	0, 1, 0, 0, 1, 0, 0, 1, 0, 0, 1	
Ca_FertOrExtOrgAmount [Zn1...4]		(Crop management/Fertilizer and organic input schedule)
N1[Zn1,2,3,4]	0,30,45,60	
N2[Zn1,2,3,4]	0,30,45,60	
Ca_FertOrExtOrgAmount [Zn1...4]		(Crop management/Fertilizer and organic input schedule)
P[Zn2,3,4]	0,60,90,120	
Mn2_InitAct[Zn1...4]	0.0455	Soil Organic Matter/Initial C & N in SOM Pool
Mn2_InitSlw [Zn1...4]	0.505	Soil Organic Matter/Initial C & N in SOM Pool
Mn2_InitPass[Zn1...4]	0.364	Soil Organic Matter/Initial C & N in SOM Pool

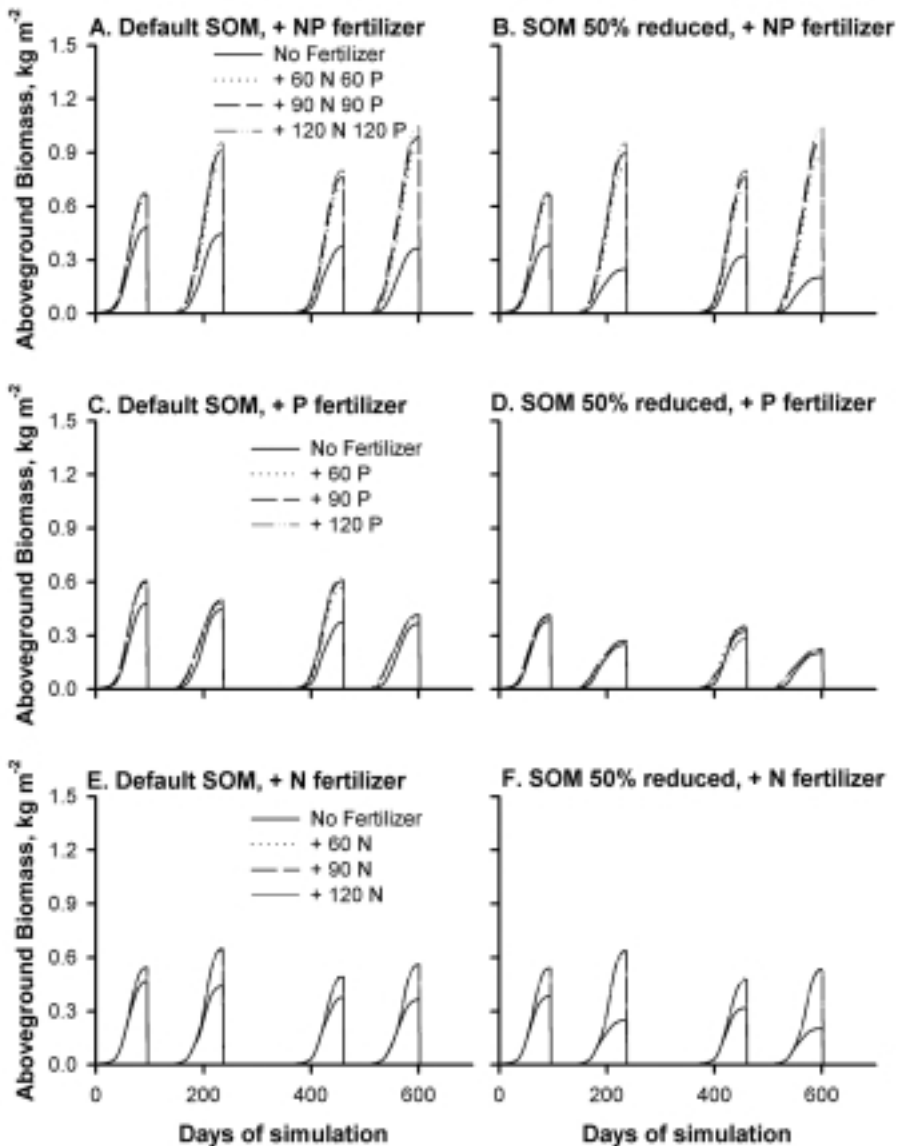

Figure 4.3 A..F. Simulated crop development (total aboveground biomass) for maize with a Lampung climate and default parameters setting (for changes in parameter settings from the default values, see Table 4.1), with or without N fertilizer (at 60, 90 or 120 kg N ha⁻¹ crop⁻¹, with split application (50% at planting, 50% at 30 days later). We also used the same amounts for P fertilizer; it is applied once at planting time. The simulation also knows the impact of reducing 50% of soil organic matter content.

4.4 Hedgerow intercropping: pruning regime and hedgerow spacing

Based on different tree characteristics ('P' and 'G' in Figure. 4.4), the model predicts different pruning frequencies to be applied (one per crop for P and two to three times per crop for G) by making modifications from the default settings as indicated in Table 4.2. The 'P trees' have some characteristics in common with *Peltophorum* as we know that in Lampung experiments while the 'G-tree' simulates *Gliricidia* (Van Noordwijk, 1996a).

The WaNuLCAS model can also predict crop yields in different strips (zones) within the alleys in a hedgerow intercropping system, by making modifications from the default settings as indicated in Table 4.3. The simulations presented here were made with version 3.0 as a first approximation of long-term hedgerow intercropping experiments in Lampung (Indonesia); details of the experiments that form the inspiration for these simulations can be found in Van Noordwijk *et al.* (1998a).

Compared to the maize series of Fig. 4.1 and 4.2 which we include as 'control', the P trees can partly alleviate the yield decline over time, while the G trees the second crop in each year produces more biomass than the first crop. Averaged over four crops and expressed on a whole-field basis, predicted crop yields for the P hedgerow intercropping system are similar to this control crop while for the G hedgerow intercropping system are slightly higher than this control crop. Hedgerow intercropping will clearly give increased crop growth in zone 4, where the positive effects of mulch are felt, without much shading.

The overall trend in crop yields is negative for P trees and less so for G trees, as the P system is gradually depleting its N stocks, in the absence of atmospheric N₂ fixation in P trees or maize. In the long term field

Table 4.2 Input parameter modifications to generate example 4.4

Parameter		Input /Output Section location
INPUT	New Value	
T_PrunLimit	0.1	Management/Pruning Events

experiments in Lampung crop yields for the control indeed declined rapidly, but no such yield decline was recorded for the treatments resembling P trees.

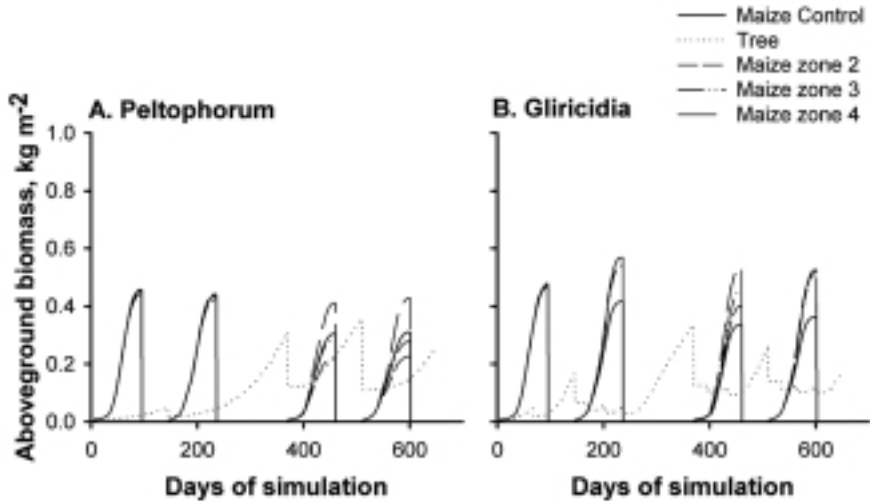

Figure 4.4 Model predictions with WaNuLCAS 3.0 of development of hedgerow tree canopy and crop biomass (on a whole field basis) over four cropping seasons in two years, for three crop zones (2, 3 and 4) within the alleys (the P and G trees approximate Peltophorum and Gliricidia, respectively, as used in experiments in Lampung (Indonesia); van Noordwijk *et al.*, 1998a); zones 2, 3 and 4 are 1 m wide each; soil type, rainfall pattern and potential maize production inputs were derived from the Lampung site

Table 4.3 Input parameter modifications to generate example 4.5

Parameter	New Value	Input /Output Section location
INPUT		
Same settings as above with different AF_ZoneTot		Agroforestry zone
AF_ZoneTot	4, 8, 16, 32	
AF_Zone[Zn1]	0.5, 0.5, 0.5, 0.5	
AF_Zone[Zn2]	1, 1, 1, 1	
AF_Zone[Zn3]	1, 1, 1, 1	
AF_Zone[Zn4]	1.5, 5.5, 13.5, 29.5	
T_PrunLimit	0.1, 0.3	Management/Pruning Events

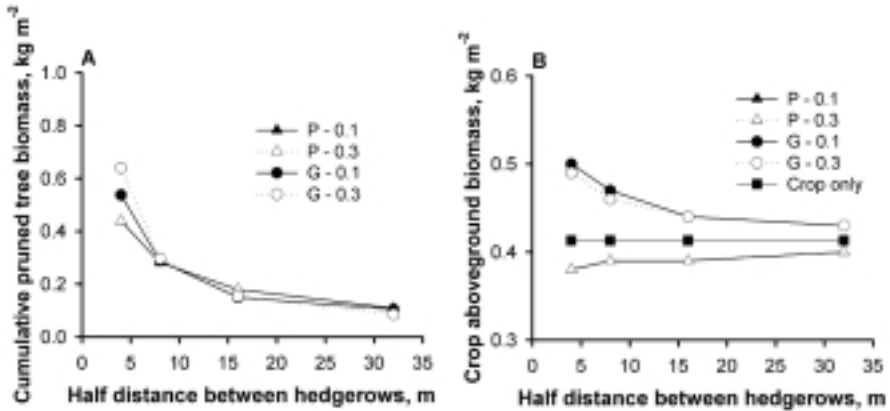

Figure 4.5 Predicted effect on cumulative pruned tree biomass (A) average crop biomass of four cropping seasons (B) if the distance between two hedgerows is gradually increased; results are given for P and G trees (compare Fig. 4.2 and two values of the 'prune limit', i.e. the hedgerow canopy biomass at which hedgerows are pruned back (For details see Table 4.3); and control refers to a whole field planted with crops

The G parameterisation (wider canopy shape, lower LAI within the canopy, shallower roots, N fixation) leads to crop yields that are substantially above the control yields due to biomass pruned from *Gliricidia* higher than *Peltophorum*. From the third crop onwards, however yields in zone 3 as well as 2 will be higher than those in the control. In the longer run hedgerow intercropping with G trees is predicted to lead to substantial gains over the pure crop control.

If the distance between hedgerows is gradually increased (Fig. 4.5), the various positive and negative effects on crop yield result in a rather complex overall response. The cumulative pruned biomass clearly decreases with increased hedgerow spacing, but differs remarkably little between the two values of the prune limit: the higher frequency of pruning at a low prune limit compensates for the smaller biomass per pruning event. Crop biomass with the G tree tends to decrease with increasing of the distance between hedgerows but still above the control value while with the P tree crop biomass slightly increase although below the control value.

The P trees with different prune limit does not give significant different on the crop biomass, while the G tree with high prune limit (G = 0.3) crop biomass lower than G tree with lower prune limit (G = 0.1).

In contrast to Fig. 4.2, the results of Fig. 4.5 can not be compared with any existing experiments we know of, as hedgerow spacing has seldom been

systematically evaluated in hedgerow intercropping experiments. The pattern predicted here is more complex at wider hedgerow spacing than the simple 'shade and mulch' model of Van Noordwijk (1996b), which did not consider spatially zone effects (which matter especially at wider spacing).

4.5 Tree fallow - crop rotations

The WaNuLCAS model can also be parameterised for simulating crop yields on small farms where part of the plot is currently under a tree fallow (such as the *Sesbania* fallows currently tested in Southern Africa), and other parts are cropped. The crop-fallow mosaic will not be drastically different from a hedgerow-intercropping situation: the spacing between hedgerows is wider, broader zones of tree growth replace hedgerows and the pruning regime is modified, but otherwise the processes of tree-soil-crop interactions are the same.

The simulations presented here were made with version 3.0 based on default setting with not applying fertilizer. Parameters modification needed to simulate the system are shown in Table 4.4. The simulation requires two runs in which output from the 1st run becomes input for the 2nd run. Notice also that output values from the tree zone should become the input values in crop zone and vice versa. The soil nutrient content of the tree zone can be directly used as input for crop zones while we need to start the tree zone with the weighted average of output from crop zones. Here is an example of how to do that for initial N in 1st soil layer.

For the tree zone:

$$N_Init1[Zn1] = (AF_Zone[Zn2]*N_Soil1[Zn2]+AF_Zone[Zn3]*N_Soil1[Zn3]+AF_Zone[Zn4]*N_Soil1[Zn4]) / (AF_Zone[Zn2]+AF_Zone[Zn3]+AF_Zone[Zn4])$$

For the crop zone:

$$N_Init1[Zn2] = N_Init1[Zn3] = N_Init1[Zn4] = N_Soil1[Zn1]$$

The soil organic matter pools increased in size during a fallow period (in the model mainly by litter fall, which is supposed to be mixed through the upper soil layer by abundant faunal activity) and depleted during cropping. The model predicts that there will be substantial 'border effects' of the fallow on neighbouring crop land, not only caused by shading (zone 2) but also by root competition (zone 3).

Table 4.4 Input parameter modifications from default to generate example 4.6 and output parameters to retain.

Parameter for 1st run			Location on WaNuL-CAS Input/Output Section
INPUT	New Value		
AF_Zone[Zn1]	10		Agroforestry Zone
AF_Zone[Zn2]	2		
AF_Zone[Zn3]	3		
AF_ZoneTot	20		Agroforestry Zone
Ca_PlantYear[Zn2...4]	0, 1, 1, 2, 2, 3, 3, 4		Crop Management
Ca_PlantDOY[Zn2...4]	304, 80, 304, 80, 304, 80, 304, 80		Crop Management
T_CanHMax	5		Tree Library/Canopy
T_CanWidthMax	12		Tree Library/Canopy
T_PrunPlant?	0		Management/Pruning Event
T_PrunYear	2		Tree Management
T_PrunDOY	300		Tree Management
T_PrunFracD	0.7		Tree Management
Ca_FertOrExtOrgAppYear	100		Crop Management
	Graph A	Graph B	
Rt_TLrvL1[Zn1...4]	4, 1.6, 0.64, 0	4, 4, 4, 0	Tree Library/Root
Rt_TLrvL2[Zn1...4]	1, 0.4, 0.16, 0	1, 1, 1, 0	Tree Library/Root
Rt_TLrvL3[Zn1...4]	0.5, 0.2, 0.08, 0	0.5, 0.5, 0.5, 0	Tree Library/Root
Rt_TLrvL4[Zn1...4]	0.1, 0.04, 0.016, 0	0.1, 0.1, 0.1, 0	Tree Library/Root
OUTPUT			Remark
Mn_Act[Zone]			Use Values at the end of run as initial values for the 2 nd run
Mn_Slw[Zone]			
Mn_Pass[Zone]			
Mn_Struc[Zone]			
Mn_Metab[Zone]			
Mn2_Act[Zone]			
Mn2_Slw[Zone]			
Mn2_Pass[Zone]			
Mn2_Struc[Zone]			
Mn2_Metab[Zone]			
W_Theta _f [Zone]/			
W_FieldCap _f [Zone]			
N_Soil _f /SINut _f [Zone]			

Parameter for 2nd run	Location on WaNuLCAS Input/Output Section	
INPUT	New Value	
Same setting as 1 st run with additional below		
AF_Zone[Zn1]	5	Agroforestry Zone
AF_Zone[Zn2]	3	
AF_Zone[Zn3]	2	
AF_ZoneTot	20	Agroforestry Zone
Ca_PlantYear[Zn1...3]	0, 1, 1, 2, 2, 3, 3, 4	Crop Management
Ca_PlantDOY[Zn1...3]	304,80,304,80,304,80,304,80	Crop Management
Mn_Act[Zone]	Use Values resulted from 1 st run. Make sure result from crop zones become input from tree zone and vice versa (see explanation in text)	
Mn_Pass[Zone]		
Mn_Struc[Zone]		
Mn_Metab[Zone]		
Mn2_Act[Zone]		
Mn2_Slw[Zone]		
Mn2_Pass[Zone]		
Mn2_Struc[Zone]		
Mn2_Metab[Zone]		
W_Theta[Zone]/		
W_FieldCap[Zone]		
N_Soil[SINut,Zone]		
OUTPUT		
T_Biom	Table 1 page 1	
C_Biom[Zn1...3]		

The WaNuLCAS model may offer the first opportunity to consider crop-fallow mosaics as a coherent system, in stead on only regarding the sequential effects on plots that are supposed to be spatially isolated. The models may stimulate a renewed research attention on border effects in crop-fallow experiments, as no published data exist on the topic. Substantial border effects of teak (*Tectona*) stands in Java (Indonesia) were described in the 1930's (publications of Coster, reviewed in Van Noordwijk *et al.*, 1996), and these were larger than what WaNuLCAS predicted for the parameters in Fig 4.6. Unfortunately, no tree root length densities are known for these (or similar) teak stands. Border effects in crop-fallow mosaics make that the overall effect will depend on the scale (absolute plot size) and not only on the crop: fallow ratio.

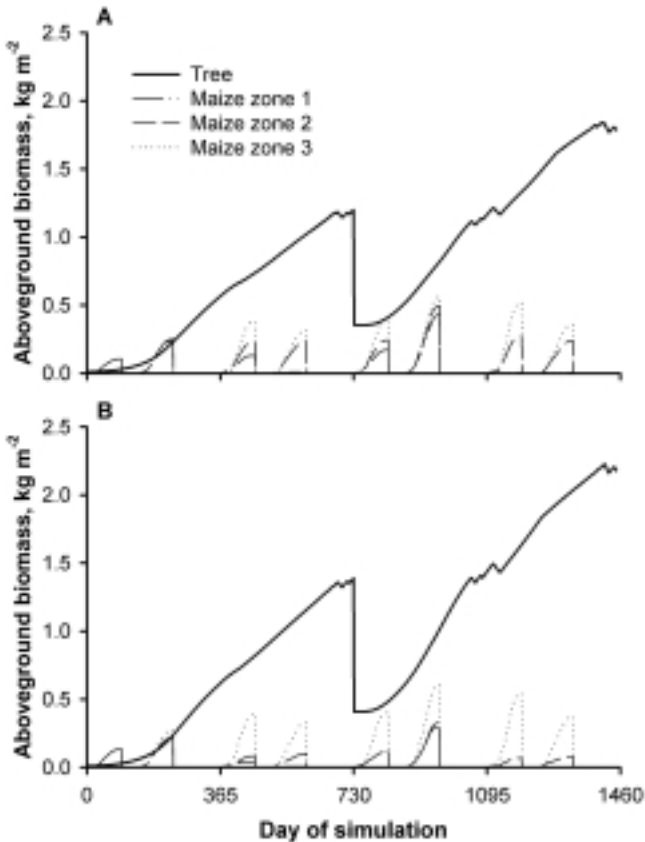

Figure 4.6. Predicted development of a tree fallow vegetation as well as the simultaneous yield of crops with increasing distance to this fallow plot, over two cycles of a two year fallow and 2 years of cropping (4 crops/cycle); A. tree root length density decreases by a factor 0.6 from zone 1 to zone 2 and again from zone 2 to zone 3; no tree roots in zone 4; B. Tree root length density in zone 2 and 3 is equal to that in zone 1, but there are no tree roots in zone 4

4.6 Contour hedgerows on sloping land

Figure 4.7B gives initial results for a contour hedgerow system on sloping land, cumulated over four crops. The simulations presented here were made with version 1.1. Model comparisons were made to separate the terms of the general tree-soil-crop interaction equation (Chapter 1), but adding two effects of slope: 1. Topsoil can be redistributed from the upper to the lower part of the alley, forming a terrace, but exposing crops in the upper alley to subsoil with a lower organic matter content, 2. Water will be re-distributed by run-off in some zones and run-on in others. If we follow the lines in the figure from left to right, we see that the effect of not growing crops on the space reserved for hedgerows is negative, but that the uneven water infiltration can make up for the yield loss in the humid series (it reduces N leaching from the

crop zone). Considering a regularly pruned hedgerow on the contour instead of a bare strip has a moderate positive effect on crop yields, but terrace formation has a negative effect on yields. For the sub-humid series all effects are weak, and no treatment combination can make up for the space lost to make the contour strip. The results per crop zone (Figure 4.7C and D) contain some surprises, as they show a range of patterns between crops: for some crops the middle of the alleys gives the highest yield, for others the lower alley, or even the upper alley. Although all types of patterns can be observed in real-world experiments, it is surprising that the balance of positive and negative interactions can, apparently, change so easily in the complexity of the WaNuLCAS model. Stride for prominence. Further model validation is necessary before any soil, climate, tree and crop specific model predictions should be seen as more than 'interesting hypotheses'.

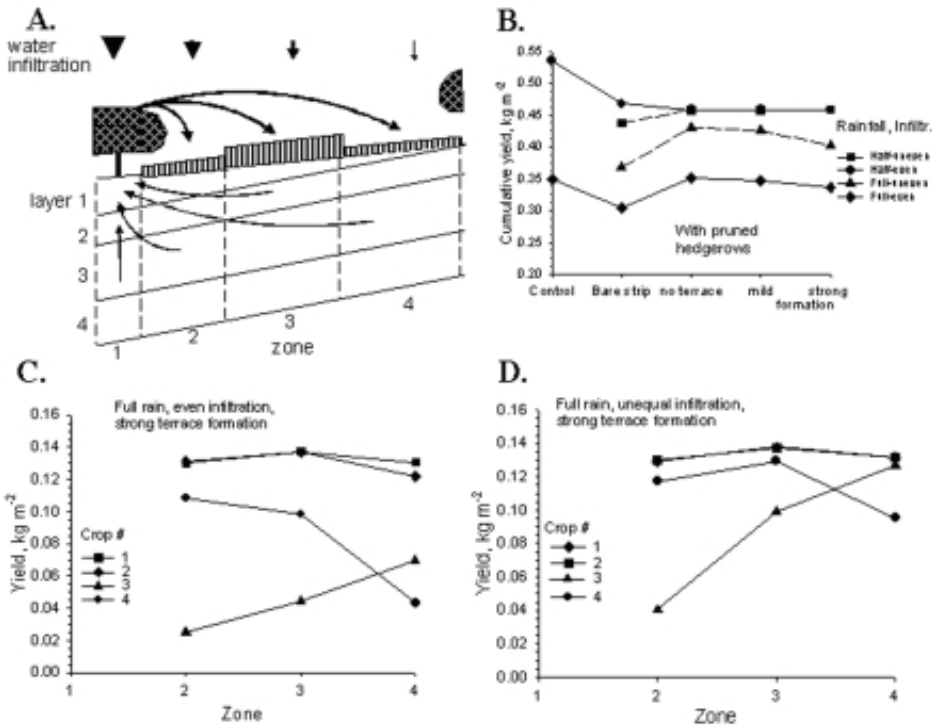

Figure 4.7. Calculations with the WaNuLCAS model (Van Noordwijk and Lusiana, 1999) of crop yield in a contour hedgerow system on sloping land; A. Model scheme for applications on sloping land; B. Cumulative yield over four crops (2 years) for a humid (3 000 mm/year) and sub-humid (1 500 mm/year) climate, with and without uneven infiltration of rainfall over the respective zones; C. and D. results per crop and zone

4.7 Tree-soil-crop interactions across a rainfall gradient

To further explore the sensitivity of the model a series of calculations was made for an agroforestry system with scattered trees and crops growing on all land except for a circle directly around each tree (Fig. 4.8).

For these runs the soil profile consisted of four layers (15, 15, 50 and 30 cm thick, respectively) and had a sandy texture (61% sand, 11% silt, 28% clay) and a bulk density of 1.3 Mg m^{-3} and thus had a rather low water holding capacity according to the pedotransfer function. Calculations were made for five climate zones, based on random daily rain events with a set monthly average and daily rainfall probability of about 20%. The five climates consisted of:

- annual average 240 mm (1 month of 30 mm, followed by 3 months of 60 mm and 1 month of 30 mm; in practice the average was 285 mm for the runs presented here),
- annual average 450 mm (1 month of 75, followed by 3 months of 100 and 1 month of 75 mm; in practice the average was 525 mm)
- annual average 1000 mm (1 month of 125, followed by 5 months of 150 and 1 month of 75 mm; in practice the average was 937 mm)
- annual average 1500 mm (10 months of 150 mm; in practice the average was 1645 mm)
- annual average 2400 mm (12 months of 200 mm; in practice the average was 2285 mm).

As the same starting value was used for the random generator, all runs for different agroforestry systems in a given climate were made with the same daily rainfall pattern. The simulation run was 2 years, and two crops were grown per year for the 1500 and 2400 mm rainfall zone. Simulations for pure crops (covering the whole field) were compared with those of trees only (unrestricted tree growth) or agroforestry systems where trees occupied the inner circle and crops the remainder of the land. The trees were pruned at sowing time for each crop, and a second time during the crop if their biomass exceeded a set value of 0.2 kg m^{-2} (averaged over the whole field). For comparison a set of simulations was included where the tree was pruned in the same way as in the agroforestry system, but where no crop was grown. Four variants were considered for the agroforestry system, indicated by 'narrow', 'medium', 'broad' and 'very broad' tree canopies with a crown diameter of 1, 2, 3 or 4 quarts of the diameter of the whole system. Note that all zoning is relative to tree size and no absolute distances have to be

specified. Tree root length density was 2, 1.5, 0.6 and 0.2 cm³ for the four depth layers directly under the tree, respectively, and 0.6, 0.36, 0 times that value in the three other zones, respectively; thus tree roots were confined to a circle of 3/4 the total diameter. The tree was able to derive 40% of its daily N demand by atmospheric nitrogen fixation and tree N could be transferred to the crop via litter fall and tree prunings, based on a gradual N mineralization. The crop was supposed to have a 98 day duration and a rather shallow root system, with a harvest index under non limiting conditions of 41%. No N fertilizer was used.

From the simulation results using WaNuLCAS version 1.1, we focus here on grain production (actual harvest index was between 36 and 41%), stem wood production for the tree (treating crop residues, litter fall, pruning and current tree canopy as intermediate components of the system). The simulation involved a gradual shift from water to nitrogen as the major factor limiting crop production. At high rainfall the total N the first crop in the pure crop control effectively exhausted supply in the soil and the three following crop yields were low. Under these conditions the agroforestry system could increase crop yield (by up to 8%), by supplying at least some N for the later crops, thus compensating for the area without a crop and competition effects on crop growth. The medium tree canopy shape (2/4) gave the highest crop yield of all agroforestry systems in the three wettest climates. For the simulations at 450 and 240 mm rainfall, crop yields were reduced in agroforestry by 11 and 35% respectively, as competition for water dominated over positive effects on N supply; at 450 mm the four agroforestry systems gave equal grain yields, while at the 240 mm run, the narrow tree morphology was best. In contrast to grain yield, wood production was always higher in the pure tree system than in the agroforestry system. The narrow tree morphology produced more wood, as it invested less resources in a leaf + fine branch canopy.

Total yield for the agroforestry system can be calculated if the value of wood can be expressed relative to that of grain. In Fig. 4.8 a 1:4 ratio is used. In the driest simulations there is agroforestry system will reduce total yield, while the curve for the 450 mm zone is nearly flat (and a slightly higher or lower relative value of wood (or other tree products) could shift the balance). For the three wettest climates the positive effects of agroforestry on grain yield are accompanied by additional wood production and agroforestry is superior, unless the relative value of wood is at least 50% higher then we assumed here. The additional production of agroforestry is based on a more complete use of water: the fraction of rainfall draining from the profile is substantially (about 15-20% of rainfall) reduced by the tree crop combination,

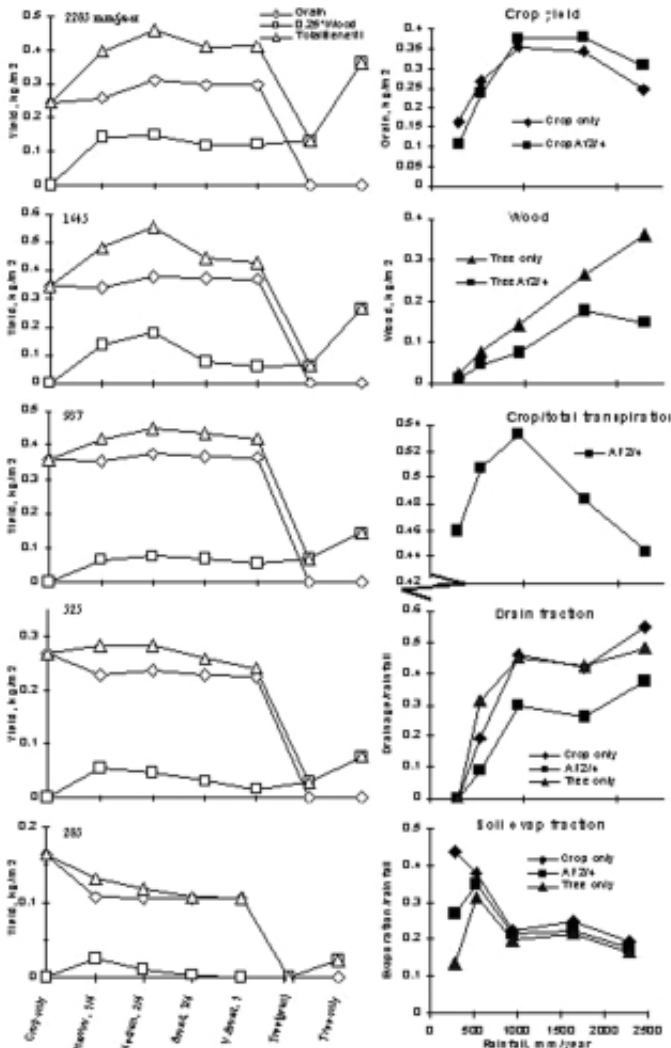

Figure 4.8 Calculations with the WaNuLICAS model of grain and wood production and water use for a range of annual rainfall conditions in an agroforestry system with isolated trees which are pruned when a crop is sown, resembling an early stage of a parkland system; production is accumulated over 2 years, involving 4 (at 2285 and 1645 mm/year) or 2 crops of 98 days duration, on a sandy soil with limited N mineralization from soil organic matter (for main parameter settings see text)

while model results for soil evaporation losses are intermediate between pure crop and pure tree systems

The share of the crop in total transpiration was always around 50% and peaked in the 1000 mm rainfall situation. Crop water use efficiency was highest at the driest site, as N limitations reduced it in wetter zones. For the tree water use efficiency was not affected by climate as its N fixation was not limited by drought.

As a whole, model calculations may present a reasonable correspondence with real world options, although no experimental data sets exist on the same agroforestry system at the same soil but widely differing rainfall conditions. Any of the effects mentioned here would vary with parameters such as soil depth, soil texture, tree canopy characteristics and rooting pattern or crop root length density, but the basic pattern of response to climate zones would remain determined by overall resource availability. Model results agree with conclusions about the perspective of simultaneous agroforestry systems from experimental evidence (Rao *et al.*, 1997; Breman and Kessler, 1997). Mobbs *et al.* (1998) and Cannell *et al.* (1998) came to similar conclusions on the basis of the HYPAR model, which gives a more detailed treatment of aboveground processes and a similar, but less elaborate treatment belowground.

4.8 Model parameter sensitivity for P uptake

WaNuLCAS model was used to explore the effect of root density and presence of mycorrhiza on phosphorous uptake in agroforestry systems (van Noordwijk, *et al.*, 1999)

The predicted P uptake for both tree and crop (Fig. 4.9A and B) respond to changes in root length density (Lrv) and mycorrhizal parameters and initial soil P content as one might have expected, with mildly negative responses to increased effective root length density by the other partner (tree or crop). The model's sensitivity indicates that reasonable estimates of effective root length density will be essential for a 'process-based' model. When rhizosphere modification is included (Fig. 4.9C and D), the results point to a clear effect of the synlocation parameter in deciding whether the net effect for the crop of trees with P mobilizing properties will be positive or negative.

4.9 Hedgerow intercropping: safety-net function of tree roots

The WaNuLCAS model can be used to estimate the tree root length density in the subsoil required for efficient functioning of a safety net (Fig 4.10). A practical definition of the safety net efficiency is the tree N uptake from the soil layers considered, as fraction of total output from this layer by leaching plus uptake. An additional output variable had to be created to capture this parameter.

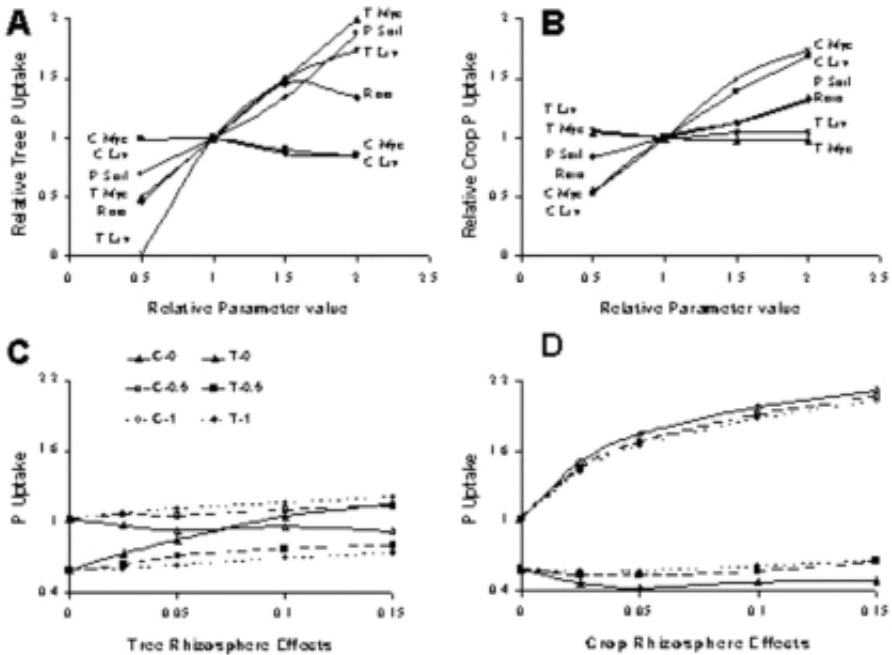

Figure 4.9 Preliminary calculations with the WaNuLCAS model after incorporating a P balance. A and B Sensitivity of predicted P uptake by tree (A) and crop (B) to changes in parameters for root length density T_{Lrv} and C_{Lrv} , respectively), mycorrhiza (C_{Myc} and T_{Myc}), soil P content (P_{Soil}) and rainfall. C and D. Effect on P uptake by tree (T) and crop (C) of rhizosphere modification by the tree (C) and crop (D), depending on the synlocation parameter (0 = only plant modifying rhizosphere benefits, 1 = benefits shared on basis of root length density)

WaNuLCAS calculations (Cadisch *et al.*, 1997) (using version 1.1) where tree root length density in the subsoil was varied over the 0 - 2 $cm\ cm^{-3}$ range indicated that about 25% of the N leaching below the crop roots can not be recovered (for the soil, climate and tree parameters used) by hedgerow tree roots as it occurs at times that the tree have no current unsatisfied N demand. A nearly linear increase was predicted in safety net efficiency (tree N uptake from the soil layers considered, as fraction of total output from this layer by leaching + uptake) between a tree root length density of 0 and 1 $cm\ cm^{-3}$. The model thus predicts that under conditions of continuous leaching a substantially higher tree root length density is needed than what would be adequate for near complete N uptake without a rainfall excess (Van Noordwijk, 1989; De Willigen and Van Noordwijk, 1987). Further data from trials in Lampung (Rowe *et al.*, 1999), are in line with this model.

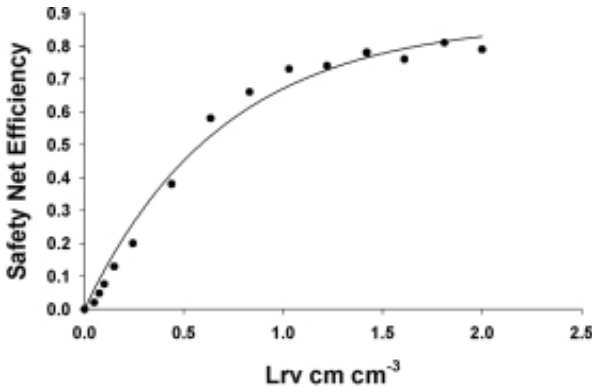

Figure 4.10 Use of the WaNuLCAS model to estimate the tree root length density in the subsoil required for efficient functioning of a 'safety net' (modified from) Cadisch *et al.* (1997); model runs were made with an N adsorption constant K_a of 0.2, reflecting a nitrate-dominated situation as can be expected at high soil pH values

4.10 Water and Nutrient Use efficiency in Agroforestry Systems

Farming systems purely based on annual food crops during and directly after deforestation generally lead to degradation of soil. Establishment of timber and/or fruit trees in cropped fields is feasible and offers better prospects in term of its sustainability. The efficiency of water and nutrient use in agroforestry systems can be used as an indicator of systems sustainability. In this study WaNuLCAS was used to assess the water and nutrient use efficiency in three alley cropping systems (Suprayogo, *et al.*, 2002) The crop component is maize and the tree components are: *Paraserianthes falcataria*, *Hevea braziliensis* and *Swietenia mahagony*.

In this study water use efficiency is defined as: $E_{\text{water}} (\%) = (T_c + T_t)/R * 100$, where:

- E_{water} = water use efficiency
- T_c = crop transpiration
- T_t = tree transpiration
- R = amount of rainfall

nutrient use efficiency is defined as: $E_{\text{Nutrient}} (\%) = (N_c + N_t)/(N_{\text{Leach}} + N_c + N_t) * 100$, where:

- E_{Nutrient} = Nutrient use efficiency
- N_t = tree nutrient uptake
- N_c = crop nutrient uptake
- N_{Leach} = amount of nutrient leached

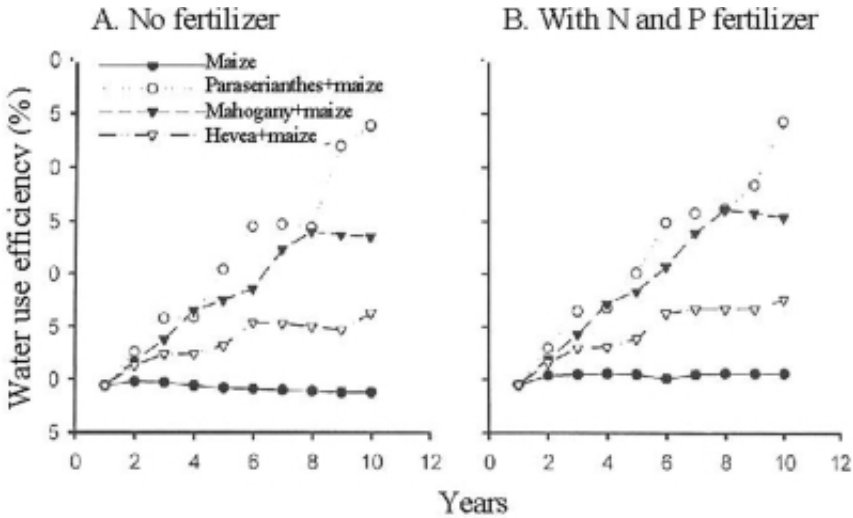

Figure 4.11 Water use efficiency at different agroforestry systems: maize monoculture, paraserianthes + maize, mahogany + maize and hevea + maize. (A) no fertilizer and (B) with N and P fertilizer

Result shows that water use efficiency in tree based systems tend to increase with increasing age of the tree (Figure 4.11). Paraserianthes-maize is the systems with highest water use efficiency while Hevea-maize is the systems with lowest water use efficiency. Presence of trees in the system also reduced runoff and increased supply to ground water stores.

N-use efficiency in tree-based systems also tends to increase with increasing age of the tree (Figure 4.12). Mahogany-maize is the systems with highest N-use efficiency while Paraserianthes-maize is the systems with lowest N-use efficiency. The use of N fertilizer caused the N-use efficiency to decrease since N leaching becomes higher. On the other hand, P-use efficiency tends to decrease with increasing age of the tree. This is because P is an immobile nutrient that stimulates accumulation of P in the soil producing low P leaching.

4.11 Management options for agroforestry parkland systems in Sapone (Burkina Faso): separating the tree-soil-crop interactions using WaNuLCAS

Trees in the parkland systems of West Africa provide food and income, but also interact with the grain crops. Competition and complementarity in

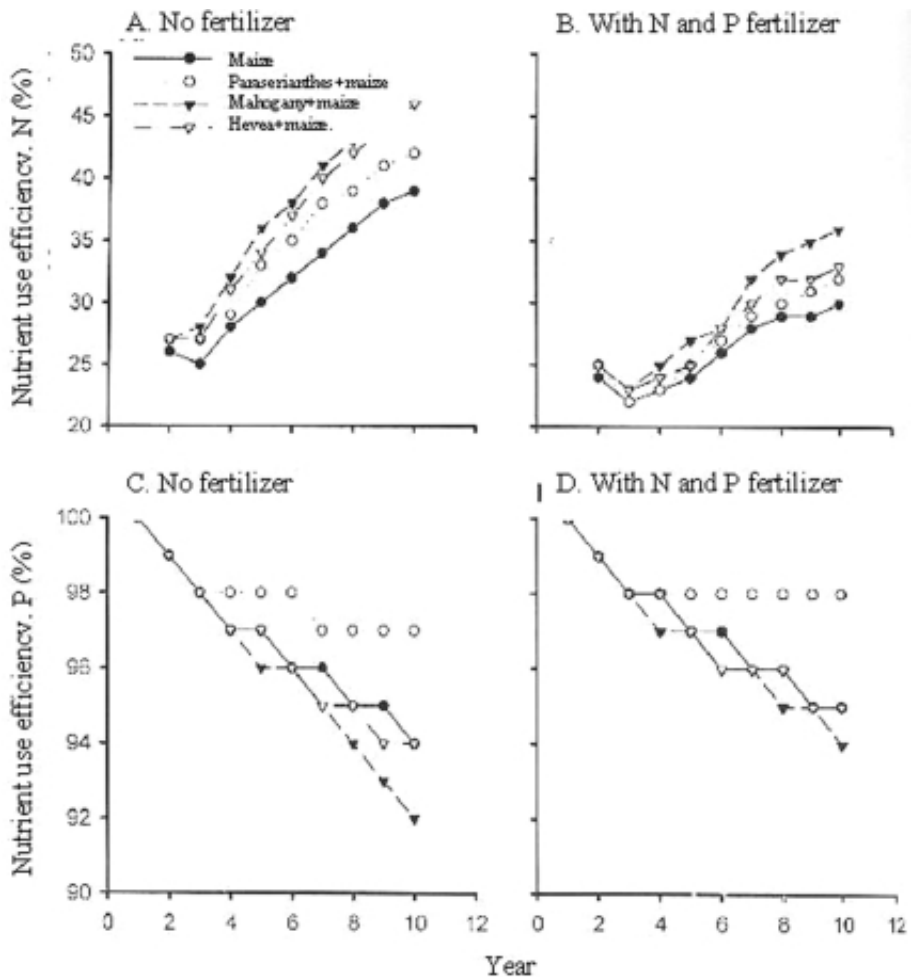

Figure 4.12 Nutrient (N and P) use efficiency in the different agroforestry systems: maize monoculture, parasitanthus + maize, mahogany + maize and hevea + maize. (A and C) no fertilizer and (B and D) with N and P fertilizer

resource use between the components of these systems need to be better understood. The effects of crown pruning of agroforestry parkland systems in terms of resource capture and utilization either were investigated in an agroforestry parkland system in Burkina Faso or was analysed using the Water Nutrient and Light Capture in Agroforestry Systems (WaNuLCAS) (Bayala, *et al.*, 2004).

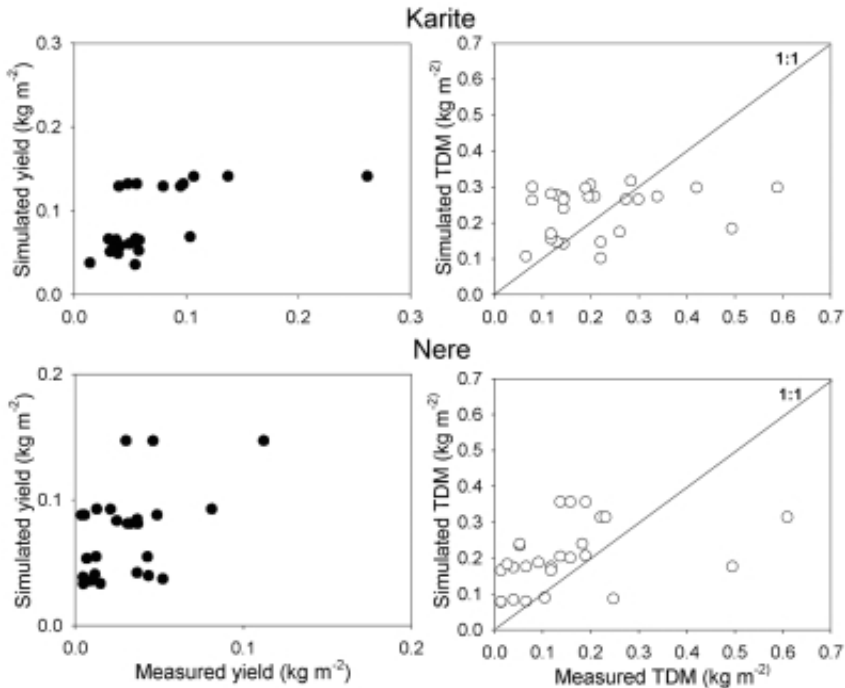

Figure 4.13 Scatter plots of measured and simulated crop yield and total dry matter (TDM) under karité (*Vitellaria paradoxa*) and néré (*Parkia biglobosa*) trees in a parkland agroforestry system in Saponé, Burkina Faso

The tree was focus on two species *Vitellaria paradoxa* C.F. Gaertn (karité) and *Parkia biglobosa* (Jacq.) Benth. (nééré) with associated crops of *Pennisetum glaucum* (L.) (millet) and *Sorghum bicolor* (L.) Moench (sorghum). Three treatments of crown pruning (totally-pruning, half-pruning and no-pruning) were applied to karité and nééré. The area under each tree was divided into four concentric tree influence zones before pruning the trees (Zones A: up to 2 m from the tree trunk, B: up to half of the radius of the tree crown, C: up to the edge of the tree crown and D: up to 2 m away from the edge of the tree crown).

Figure 4.13 shows crop performance for the various zones and pruning regimes tended to be overestimated, indicating that not all limitations occurring tin the field were adequately represented and/or that resource capture for the resources included in the model (light, water, N and P) was overestimated. Simulation with WaNulCAS indicated that the plant

components differed in the key limiting factors. For the Karite, with a relatively shallow root system and ability to fix atmospheric nitrogen, water limitation dominated for (29%, 27% and 33% of the simulation period for unpruned, half-pruned and totally pruned trees, respectively). Water limitation was also found to restrict crop growth under this species (26% of the time in unpruned and half-pruned trees, and 30% of the growing season for totally pruned) trees. P limitation restricted crop growth only 8% of the season in unpruned and half-pruned trees and 4% in totally pruned trees. Water limitation under karite is probably due to its shallow root system indicating its high dependency on rainfall water and probable less access to the ground water table. For the Nere tree the main limitations were water (11 to 32% of the simulation time) and P (15 to 42 of the simulated time). Crop growth under Nere was mainly limited by P (32 to 50% of the simulated growing season) corroborate to the findings of Tomlinson *et al.* (1995) and Bayala *et al.* (2002).

4.12 Long time effect of Legume Cover Crop (LCC), sugarcane harvest residue (trash) and Bagas (sugarcane processing waste) on soil carbon and sugarcane yield

Ultisols is a typical soil type in North Lampung, Indonesia. It is low in soil organic matter content as well as N, P and exchangeable cations. It also has high concentration of Al and Mn. Thus, the main problem in soils of North Lampung is low fertility.

Soil organic matter is the key factor to soil fertility. One way to prevent more soil degradation is to maintain soil organic matter. Maintaining soil cover throughout the year, either by cover crop or by mulch, can do this. A continuous biomass is required to stabilize the organic matter content of the soil. According to Young (1989) about 8.5 Mg ha⁻¹ annual input of aboveground biomass is required in order to maintain soil carbon content of 2%.

One of the main crops in North Lampung is sugarcane. Sugarcane yields tend to drop rapidly if there is no fertilizer input. A potential source organic input to the systems is sugarcane harvest residue (trash) and Bagas (sugarcane processing waste). Thrash is normally burnt after harvest and Bagas (sugarcane processing waste) is normally piled up around the sugarcane factory creating high risk of fire.

Brawijaya University-Indonesia had conducted an experiment to test the effect LCC, sugarcane harvest residue (trash) and Bagas (sugarcane processing waste) on sugar cane growth and production. The following applications of organic materials were tested on a soil that had been cropped for more than 10 years after forest conversion: (1) without organic materials as a control, (2) bagas 8 Mg ha⁻¹, (3) bagas 16 Mg ha⁻¹, (4) sugarcane trash (harvest residue) 8 Mg ha⁻¹. The whole plot was planted a mixed of legume cover crops (LCC) *Mucuna pruriens* var. utilis and *Centrosema pubescens* (1:1) and was given rock phosphate 1 Mg ha⁻¹ at the first year and followed by sugarcane for another 2 years.

Based on this experiment, we simulate the systems using WaNuLCAS model to see the long-term effect of the organic inputs on soil fertility

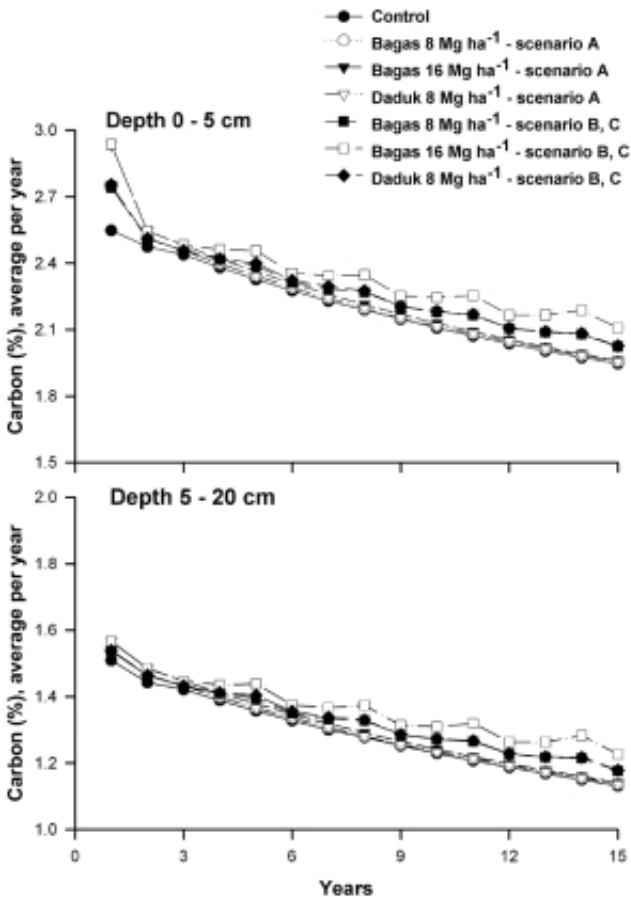

Figure 4.14 Soil organic matter content (average per year) at depth 0 - 5 and 5 - 20 cm of soil

(Hairiah, *et al.*, 2003). Three different scenarios were used: (A) external organic input given only at first year and N and P fertilizer every years with similar dosage, (B) external organic input gave every three years and N and P fertilizer every years with same dosage, (C) external organic input gave every three years and N and P fertilizer every years with different dosage (ratio dosage/years = 1.2:0.9:0.9 from default value and start from third years).

The simulation predicted that additional organic input do not significantly affect the long-term amount of organic carbon of the systems (Figure 4.14). The organic matter content at 0 - 5 cm depth decrease by 0.04 - 0.07% per year, which is faster compare to 0.02 - 0.03 % per year at depth 5-20 cm.

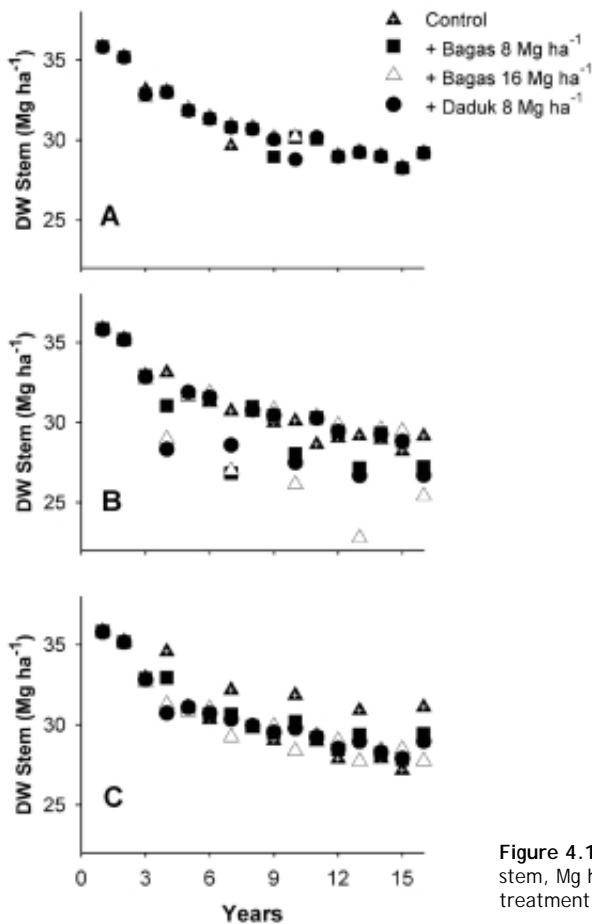

Figure 4.15 Sugarcane yield (in dry weight stem, Mg ha⁻¹) for 16 years in different treatment and scenario

The results also predicted that application of sugarcane residues to the soil lead to a slower declining rate of sugar cane yield if accompanied by application of N fertilizer (Figure 4.15). Without N fertilizer application, returning sugarcane residues will cause N immobilization in the soil causing a decrease in sugarcane yield.

4.13 The effect of agroforestry systems based on differing leaf phenologies on water balance and tree and crop growth

In Thika and NaroMoru, West of Mt. Kenya introduction of tree species into the cropping systems might aggravate the crop since water limitation is an important factor for the crop performance and yield. The differences of crop performance and yield may have relation to the tree water uptake that is corroborate to the tree leaf phenologies. The WaNuLCAS model was used to simulate water balance of the agroforestry systems based on differing leaf phenologies (Muthuri, 2003). The tree was focus on three species *G. robusta*, *A. acuminata* and *P. fortunei* associated with maize. *G. robusta* is evergreen, *A. acuminata* is semi-deciduous and *P. fortunei* is deciduous in term of tree water uptake.

Figure 4.16 and 4.17 shows the components of the water balance by the trees and crops using different leaf phenology for the Thika and Naro Moru site. The simulations of the water balance between Thika and Naro Moru site shows was not too different. Changing leafing phenology from evergreen, through semi-deciduous to deciduous generally decreased water uptake by the trees and interception of rainfall by all three trees species. Simulated total water uptake was never greater in all agroforestry systems than in sole maize, although the estimated water uptake by the crop component in the agroforestry systems was close to that for sole maize, especially when the deciduous leafing phenology scenario was adopted.

4.14 Safety net efficiency - effect of root length density and distribution

The presence of hedgerow tree in the crop field may lessen nutrient leaching. For nutrients of higher mobility leaching could be reduced if tree have a relatively dense root system beneath the crop root zone (a safety net). Cadisch *et al.*, 1997 have explore how such safety net function may depend

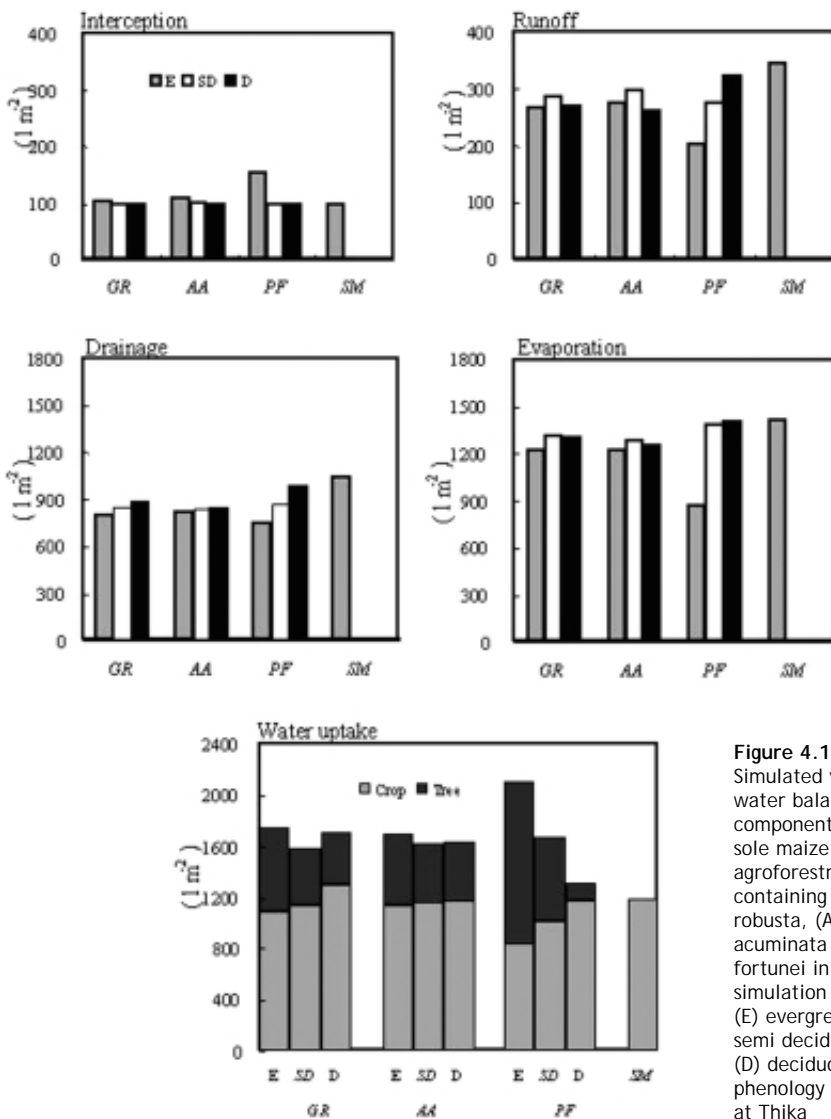

Figure 4.16 Simulated values for water balance components in (SM) sole maize and agroforestry systems containing (GR) *G. robusta*, (AA) *A. acuminata* and (PF) *P. fortunei* in five year simulation involving (E) evergreen, (SD) semi deciduous and (D) deciduous leaf phenology scenarios at Thika

on tree root length density in the layer underneath the crop root zone. WaNuLCAS was used to test the positive (safety net functions) and negative (competition for water and N) impacts of simultaneous tree roots on maize yield by separating relative tree root distribution from absolute root length density for topsoil and subsoil (van Noordwijk and Cadish, 2002).

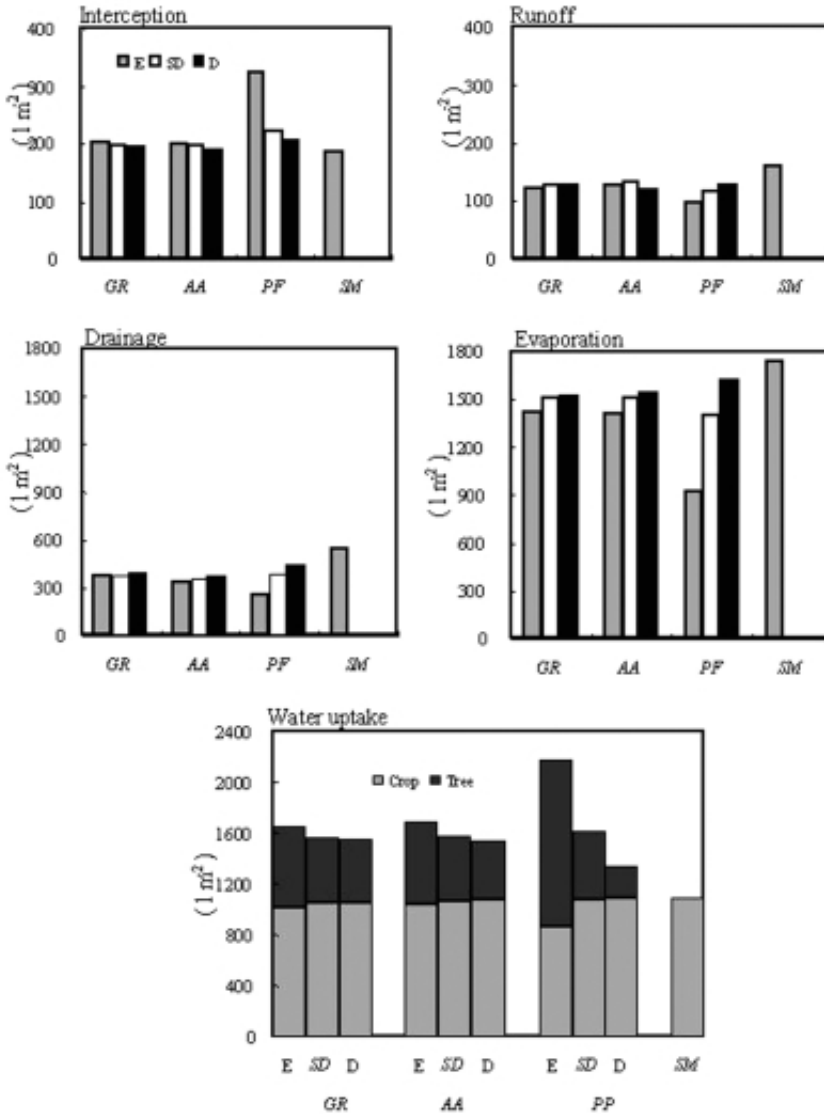

Figure 4.17 Simulated values for water balance components in (SM) sole maize and agroforestry systems containing (GR) *G. robusta*, (AA) *A. acuminata* and (PF) *P. fortunei* in five year simulation involving (E) evergreen, (SD) semi deciduous and (D) deciduous leaf phenology scenarios at Naro Moru

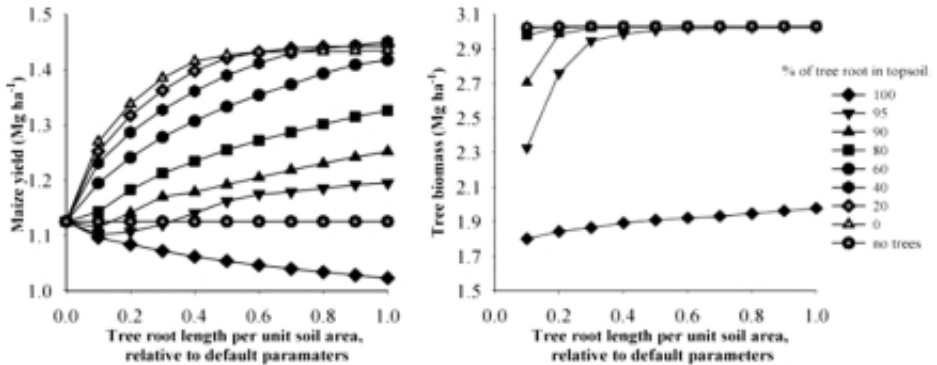

Figure 4.18 Predicted maize yield (A) and tree biomass (B) for the default rainfall situation (2318 mm year⁻¹), when relative distribution of tree roots with depth as well as total amount of tree roots are varied independently. Whereas the 'default' tree roots system had 21.5% of its roots in the top layer, a series of data was made that had 0 - 100% of its roots in the top layer and the remainder allocated to the deeper layers in proportion to the root length densities of the default case (the relative distribution over the four zones with increasing distance to the tree was not modified). For each of these root distributions, the total amount of roots was varied from 0.1 - 1 times the default, while maintaining the relative value.

Figure 4.18 shows that negative effect of the tree can be expected from trees that have all their roots in the topsoil, and from trees with only 0 - 10% of their roots in the subsoil, at low overall tree root length. These same relative tree root distributions at higher total root length (i.e. higher absolute root lengths in both top and subsoil) can have a moderate positive effect on maize yield, while tree root systems with 20% or more of their roots in the subsoil were consistently positive for crop, the higher the total root length, the more positive the impact on maize.

A remarkable feature of these results is that at default value for total root length, the tree root systems with 60% of their roots below the top soil led to (slightly) higher maize yields, than those with more (up to 100%) in the subsoil, while at total root systems size the 100% in subsoil (0% in top soil) was better for the maize. Although this effect is much too subtle to be recognized in any field data, it seems counter-intuitive.

4.15 Tree root systems dynamic - root functional and local response

Simulation models can represent belowground resource capture process at different levels of sophistication (van Noordwijk and De Willigen, 1987):

1) Level 0.

models 'without roots' using empirical resource capture efficiency coefficients for the relation between water and nutrient supply in the soil and the dynamics of plant growth,

2) Level 2.

models that differentiate between soil layers and use empirical data on relative root distribution to predict resource capture potential in each zone; root distribution can be schematised via an exponential decrease with depth (Jackson *et al.*, 1996) or its 2-dimensional elliptical variant (Van Noordwijk *et al.*, 1995), or they can be provided as 'independent' parameters for each layer or zone; change of root length densities with time can be imposed on the basis of crop age,

3) Level 3.

models that consider plants as organisms with the capacity to adjust the total amount of roots to the internal balance between above and belowground resource capture, and the location of new root growth to the parts of the root system with the best opportunities for uptake of the resource that is most limiting overall plant growth.

WaNuLCAS model can predict competition for water and nutrients between trees and crops at 'level 0' and 'level 1'. It can also be used at 'level 2' using spatial root distribution that restrictedly follows the exponential-decrease-with-depth or elliptical distributions. Stress of nutrient (N, P) or water is an important factor for the crop growth. When nutrient (N, P) or water stress occurs, the relative allocation of growth reserves to root can increase quickly.

The WaNuLCAS model was used to explore the change of root patterns due to local response (van Noordwijk, *et al.*, 2003). A series of simulations was made for a moderately deep soil (1 m) with an annual rainfall of 1000 mm. Rainfall patterns ranged from '1 = every day 3 mm of rain' and '2 = every second day 6 mm', to '6 = every 32 days 96 mm'. As the potential evapotranspiration was assumed to be 4 mm day⁻¹, this environment would not provide enough water to avoid water stress, even if all rainfall were to be fully used. Figure 4.19 shows the rainfall patterns lead to situations of permanent moderate stress (rainfall pattern 1), alternations of sufficient water and severe water shortage (rainfall patterns 5 and 6) or intermediate patterns. In the overall water balance, with a decrease in the number of rainy days (through patterns 1 to 6), a decrease in the values for the interception and soil evaporation terms can be noted, while the contribution to groundwater (deep infiltration) and runoff increases but remains small in absolute value.

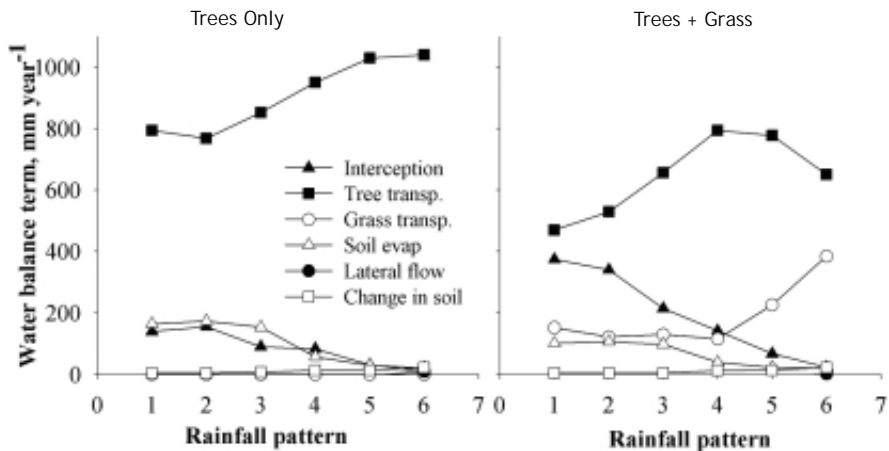

Figure 4.19 Water balance for a range of WaNuLCAS simulations, in the absence of functional or local response of the tree, with and without a grass sward

Cumulative tree water use tends to increase through rainfall patterns 1 to 6. If a grass sward is added to the simulations, canopy interception increases and thus the amount of soil water available to either tree or grass is reduced. The grass water use is predicted to benefit more from rainfall patterns 5 and 6 than the tree causing a bell-shaped response curve for the tree.

A sensitivity analysis was carried out on the two key parameters for the functional shoot/root balance and root distribution: 'Root_Allocation_Responsiveness' and 'local response'. Higher values of 'Root_Allocation_Responsiveness' lead to a more rapid shift of current growth resources to roots, at the expense of shoot growth, when the total uptake of water and/or nutrients falls short of current 'demand'. With increasing 'local response', root distribution shifts towards the soil layer and spatial zone in which roots are most successful (per unit root length) in taking up the most limiting resource.

'Local response' is simulated in WaNuLCAS by a gradual change in the parameters of the elliptical root distribution, and constrained by the total new length of roots that can be produced with the carbohydrates allocated. The intensity of change depends on the T_DistResp parameter and on the degree to which effective uptake per unit root length of the currently limiting resource differs between soil layers and zones. If roots in deeper layers are more effective (e.g. in case of water stress), the root distribution can shift to a more gradual decrease of root length density with depth (or even an inverse

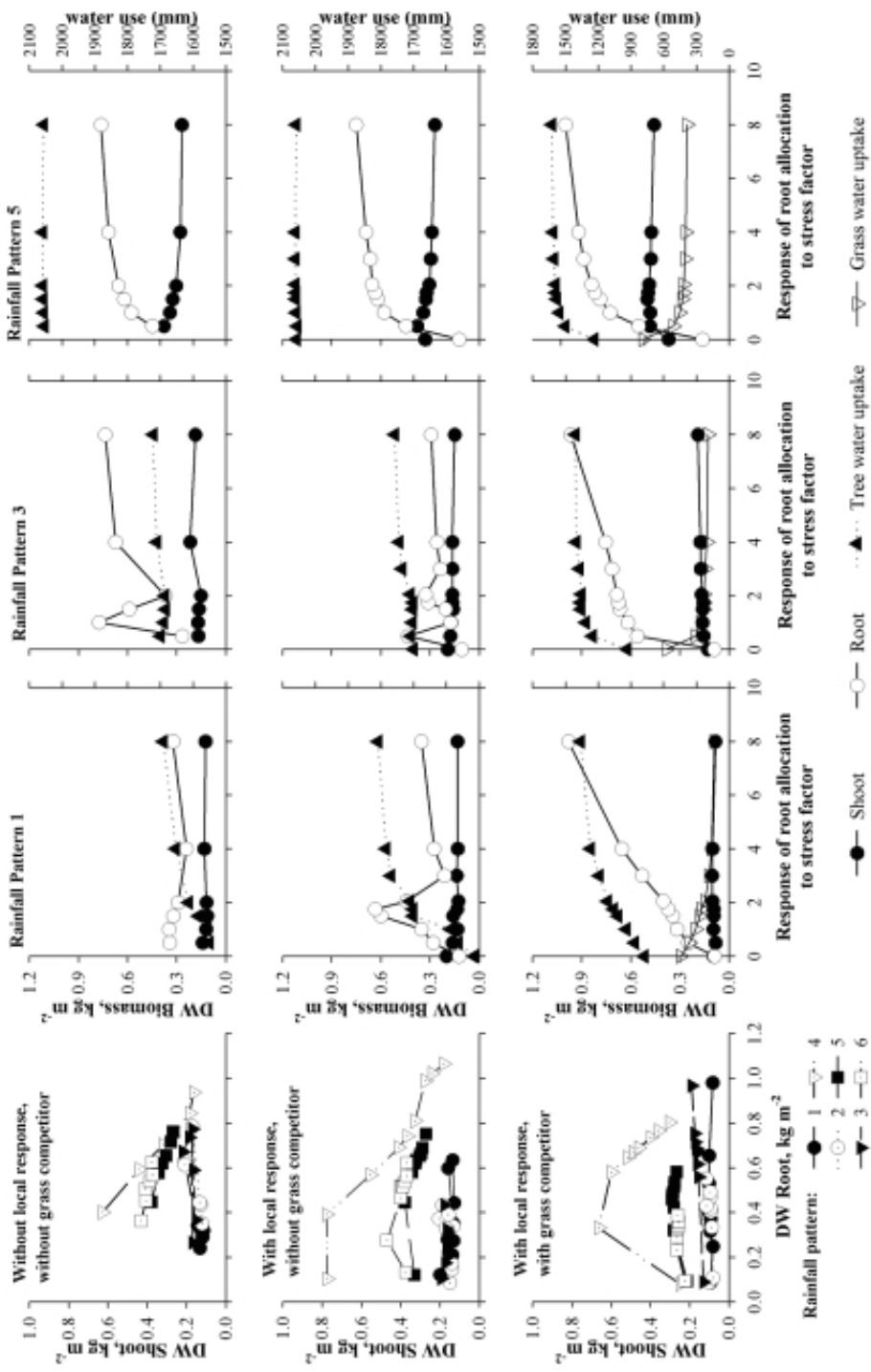

Figure 4.20 Simulation results for shoot and root dry-weight (DW) biomass and tree (and grass) water use, for three rainfall patterns and a range of parameter values for the 'root_Allocation_Response' parameter (see explanations in text). Simulations include situations with and without 'local response' (see text), and with and without competition from a grass sward

pattern...), if roots in topsoil are more effective (e.g. when P uptake is overall limiting plant growth and the topsoil has sufficient water content to keep the P mobile) roots will expand (mainly) in topsoil.

The general patterns of root and shoot response in the simulations can be understood from the re-wetting patterns of the soil (Figure 4.20). In the absence of a competitor, a stronger root allocation leads to a larger root system, but only in rare situations to a larger shoot biomass or total water use. For rainfall patterns 1-4 the 'local response' rules lead to a shallower tree root system, as the rainfall events are insufficient to rewet the whole soil profile and superficial roots are thus more effective in water uptake than deep ones. For rainfall pattern 5 and 6, however, the local response rule leads to a deeper root system. In the presence of a competing grass sward, total water use by the tree is expected to decrease substantially and the tree biomass will consequently be lower. A marked difference with the previous simulations, however, is that now a larger root allocation can actually increase tree water use and shoot biomass. The competitor is predicted to enhance the increase in the fraction of tree roots in the topsoil for rainfall pattern 1-4. For rainfall pattern 5 the presence of a grass sward is predicted to drive the tree root to a more superficial pattern, rather than the deeper pattern of the monoculture.

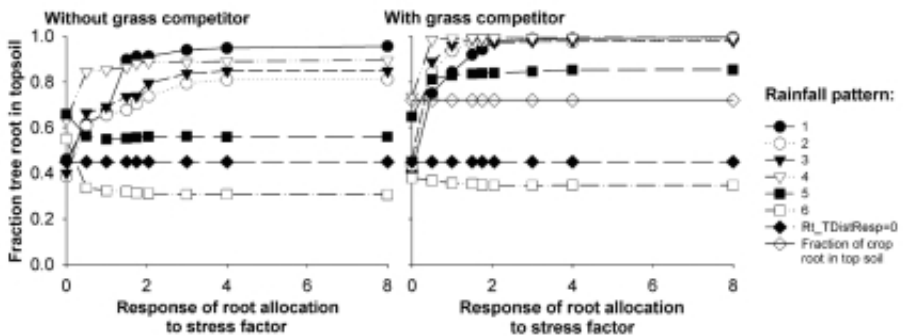

Figure 4.21 Relative tree root biomass in the upper 25 cm of the soil profile for a range of values of the factor that governs the response to stress of the biomass allocation to roots, with (right) and without (left) a competing grass; the grass is assumed not to show a functional or local response, so it has a constant fraction of its roots in the topsoil; the line $Rt_TDistResp = 0$ indicates a situation without 'local response', so the 'response to stress' can modify total root biomass, but not root distribution for this setting.

Appendix 1

Introduction to STELLA

STELLA is a flowchart-based modelling software. It enable users to construct model by drawing boxes, circles and arrows. **STELLA** is similar to ModelMaker.

During this session you will learn to build a model, step by step using **STELLA**. The purpose of this session is to familiarize yourself with **STELLA** and to learn how to use basic features of **STELLA** for simulation modelling.

Initiating STELLA

Start STELLA by clicking on its icon on the window screen. You will be automatically inside a new file.

STELLA is a multi-level hierarchical environment. It consist of 3 layers:

- (1) the High Level Mapping Layer; which contain input output relationship
- (2) Model Construction Layer; where you construct the model
- (3) an Equation View; to view list of all model elements and relations

Move between layers

- o Currently you are in the second layer. You can move between layers by clicking on arrow at the top left hand corner.
- o You will find all the layers are still empty because you have not construct anything.

Let's try building a simple model based on Trenbath (1984).

Trenbath formulated a simple model of restoration and depletion of 'soil fertility' during fallow and cropping periods, respectively.

'Soil fertility' is defined as a complex of effective nutrient supply and biological factors (diseases, weeds) affecting crop yield. Crop yield is assumed to be directly proportional to 'soil fertility'.

Assume during a cropping period soil fertility declines with a fraction D per crop, while during a fallow period soil fertility can be recreated with a fraction of R .

Constructing a model

- o Make sure you are in the second layer. You will notice a globe (world) icon underneath the arrow at the top left hand corner. On the top you will see 14 icons, starting with 'box' icon at the furthest left and 'ghost' at the furthest right.
- o Make a variable of soil fertility. To do this, click on the box icon then click again anywhere on the empty space. Change the name from 'Noname1' into 'Soil Fertility' or any variable name you like. There are no restriction on length. What you have just made is called **building blocks**.

STELLA has 4 types of building box:

1. Stocks



Stocks are accumulations. They collect whatever flows into and out of them.

2. Flows

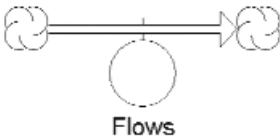

The job of flows is to fill and drain accumulations. The unfilled arrow head on the flow pipe indicated the direction of the flow.

3. Converters



The converter serves a practical and handy role. It holds values for constants, defines external inputs to the model, calculates algebraic relationships and serves as the repository for graphical functions. In general it converts inputs into outputs.

4. Connectors

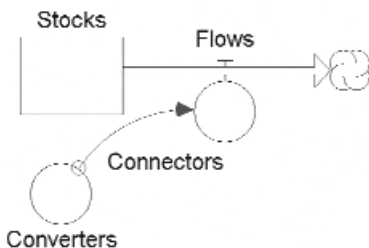

The job of the connector is to connect model elements.

This is an example of how building blocks are used.

Constructing a model (Continued.)

- o Since 'Soil Fertility' will decrease during cropping year, you will have to make an outflow from 'Soil Fertility'. Name the flow as 'Depletion'.
- o 'Depletion' depend on depleting factor (D), length of cropping year and length of fallow year (if it is a fallow year, depletion will not occur). Make 3 converters and name them as D, TimeCrop and TimeFallow. Connect all 3 converters to 'Depletion'
- o Now you will need to define the relationship between those parameters into an equation in 'Depletion'. See what happen if you click twice on 'Depletion'.
- o Click Cancel and see what happen if you click on the globe icon then clicking twice on 'Depletion'.
- o You are now in equation box. Type out the following equation:
IF(MOD(TIME, (TimeCrop+TimeFallow)) <TimeCrop) THEN
(Soil_Fertility*D) ELSE(0)1
Make sure there is a connection from 'Soil Fertility' to 'Depletion'
- o You will see that all building blocks except 'Depletion' has question mark on them. They are asking for a value. Put the following value just for a try out. D=0.4, Soil fertility=10, TimeFallow=3, TimeCrop=3
- o Now, do the same step for recreation factor, which is an inflow to 'Soil Fertility'. What do you think should be the equation in 'Recreation'? First try a constant value, for example put
IF(MOD(TIME, (TimeCrop+TimeFallow)) > TimeCrop)THEN(0.2) ELSE(0)
- o The Trenbath model used a 'saturation' function in which the recreation depends on the difference between current fertility and a maximum value (Finf), modified by a 'half-recovery time' Kfert, so we make converters for Finf (value e.g. 10) and Kfert (value e.g. 5):
IF(MOD(TIME, (TimeCrop+TimeFallow)) >TimeCrop)THEN((Finf-
Soil_Fertility)*Soil_Fertility/(Finf-Soil_Fertility+Kfert*Finf)) ELSE(0)
- o Now go to the third layer. You will now see the values and equations of your model.

1 MOD(TIME,(TimeCrop+TimeFallow)) will give current time minus the already completed cycles. The early part of a new cycle is cropped, the latter part is fallow.

Two types of output can be generated from STELLA; graphs and tables.

Making an Output

- o To make a graph click on graph icon (7th icon from left) and click again anywhere. A box named untitled graph will emerge.
- o Click twice on the graph then select 'Soil Fertility' from Allowable Box. Click the arrow pointing to the right. Then click OK.
- o You may do the same thing with table icon (8th icon from left)

Running the Program

- o To run the program choose **Run** from Run Menu. You can also run the program by pressing **Ctrl-R** or clicking the running-man icon in the bottom left hand corner then click an arrow pointing to the right.
- o To see the simulation result, click twice on the graph or table.
- o You will notice that the simulation run until time 12 with Delta Time (DT)=0.25. You can change this by choosing **Time Spec** on Run Menu. Try putting DT=1 and length simulation to 50.
- o Run the model again and see what happen.
- o Try changing R and D value. At what value would they result in stable condition?

Sensitivity Analysis

STELLA has a sensitivity analysis option. Let's try to see how sensitive 'Soil fertility' to changes in 'Depletion'

- o Choose **Sensi Spec** from Run Menu. Choose D from Allowable Box then click an arrow pointing to right.
- o Click D on Selected Box, then fill the following value: Start=0.2, End=0.6. Click on **Set** then **OK**.
- o Click twice on graph, then choose graph type as Comparative.
- o Now Run the model and see the result.

Exercises

The model you have built is very simple. Now try adding other variables to add complexity into it. Below are several exercises you may like to try out.

- o Add crop production into it. Assume crop production is linearly proportional to decreased in 'soil fertility'/depletion. Find the total crop production during simulation.
- o Assume that in the sum of cropping time and fallow time is a constant over time (a constant cycle). Fallow time is a function of total cumulative production. If the cumulative production meet a certain target then continue with the same length of fallow time. If cumulative production below target you need to shortened the length of fallow time to make up for.
- o Assume target production as a function of population density and food needed per capita.

Appendix 2

User's guide to WaNuLCAS

Introduction

This user's guide is designed to help users in working with **WaNuLCAS** model. Throughout this document, we assumed users have a basic experience on using software under Microsoft Windows.

To be able to run WaNuLCAS reasonably well the recommended system requirements are:

Pentium processor or better
Microsoft Windows™ 95
64 MB RAM
VGA display of at least 256 colors

There are two options for running WaNuLCAS:

1. Under Stella 5.0 Commercial Run Time (CRT), which is a 'stripped' version of Stella Research. You can:
 - a. run the model
 - b. change most of the parameter values within the ranges set (directly or by copying from EXCEL files), and
 - c. save/save as to maintain modified parameters
 - d. save graphs as pictures for printer
2. Under Stella Research 5.11. In addition to the above you can also:
 - a. modify parameters ('constant') not included in the input lists
 - b. modify the parameter ranges
 - c. save output tables as text files for further data handling with other software
 - d. create new graphs or tables
 - e. print a listing of all program equations
 - f. modify the layout of the model
 - g. modify equations, add or delete pools and flows, i.e. modify 'the model itself'.

If you do any modification, please keep track of changes made for any future report on your 'modified WaNuLCAS'.

This document deals with the second option that is running WaNuLCAS in Stella Regular/Research version. A free downloadable version of Stella is available at <http://www.iseesystems.com/>. All option available except saving a file.

Installing WaNuLCAS

Decompressed WaNuLCAS model and excel file from the disk. You may copy the model and the excel file into any directory. You may change the name of the model but not for the excel file. Change the name of excel file means break the link to the model. You can save on the different directory for representing different parameterization.

Starting WaNuLCAS

Initiate EXCEL. Open **Wanulcas.xls**. It will give warning that the file contains a macro.

Choose **enabled macro**. This is to make sure the macro built to ease inputting parameters in the model is working properly.

Then run **Stella**. It will automatically open a blank working model. Close it then open **Wanulcas.stm** from appropriate directory. You are now inside the **Main Menu** of WaNuLCAS and ready to work! In your screen you will see something like Figure App2.1.

Please be patient in waiting for the model to load. Inside WaNuLCAS you will see several buttons, each has specific function written on it.

To familiarize yourself with WaNuLCAS we suggest you to try the following exercise:

- o First, view the model then return to main menu
- o Second, run the model using default parameters, then look into the simulation result
- o Third, check nitrogen, phosphorus, carbon and water input-output summary of model
- o Fourth, modify input parameters and try new run
- o Fifth, import output resulting from new run

In the following sections you will find description on how to perform each of the suggested exercise.

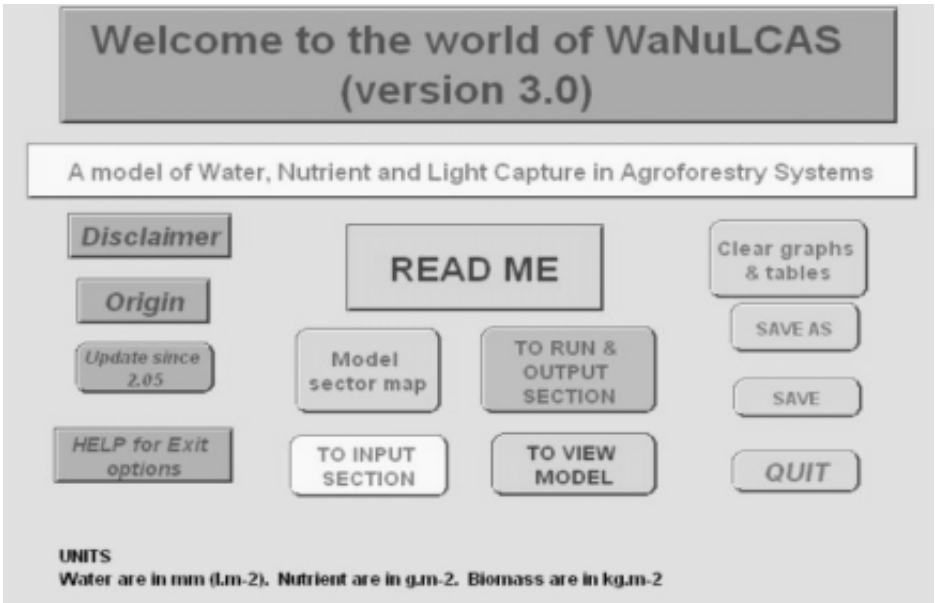

Figure App2.1. View of WaNuLCAS Main Menu

To View Model

This option will give you a bird's eye view of model structure: sectors, pools, flows and influences (see figure below). Using Stella 5.0 Research you can modify the model at this level.

To return to **Main Menu** you may click on the available button or click on an arrow pointing upwards in the top left corner.



Figure App2.2. A bird's eye view of WaNuLCAS

To Run and See Simulations Results

To run or to see simulation result from **Main Menu** click on **TO RUN AND OUTPUT SECTION** button.

Running WaNuLCAS

On the output screen you will find 5 buttons which control simulation run as listed below.

Buttons	Purpose
Run	To start simulation
Pause	To pause during simulation run
Stop	To stop simulation
Resume	To resume simulation after pausing
Time Spec	To specify length of simulation time

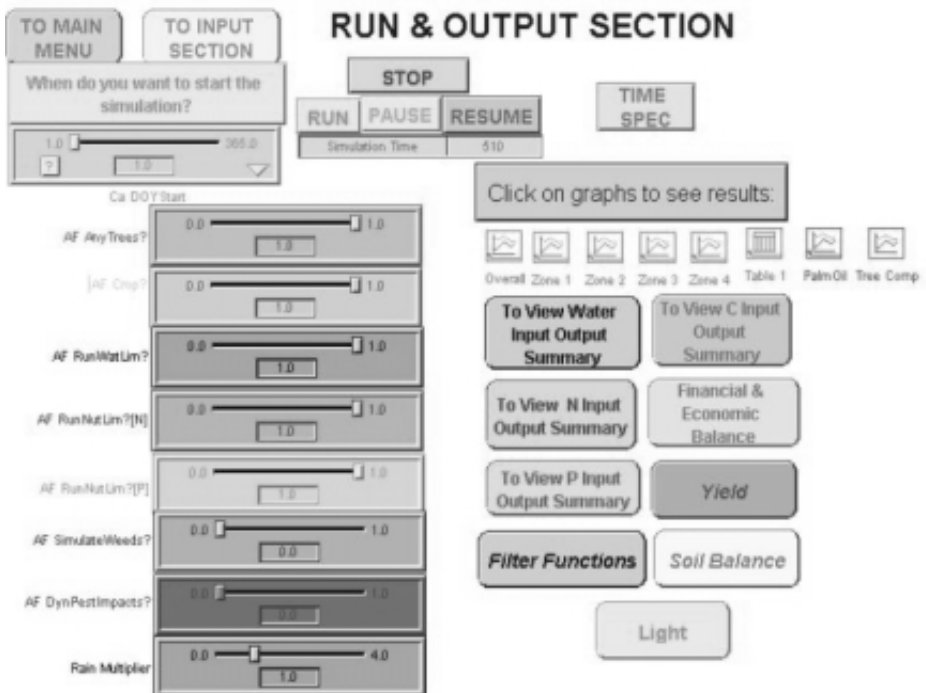

Figure App2.3. View of Output Section

Below the running control buttons, you will see a box displaying time lapsed since start of simulation (see Figure App2.3).

There are 6 sliders to simplify running different type of simulations. See Appendix 7 on acronyms to know more of the function of these sliders. The Time Specs screen will appear (Figure App2.4) allowing you to change beginning and ending period of simulation, also DT which is incremental time of simulation. We strongly advise you to keep DT value at 1.

There are 6 sliders under Click Me button. These sliders are options of a general different simulation you can run. Click on Click Me button to find out more on the function of each slider.

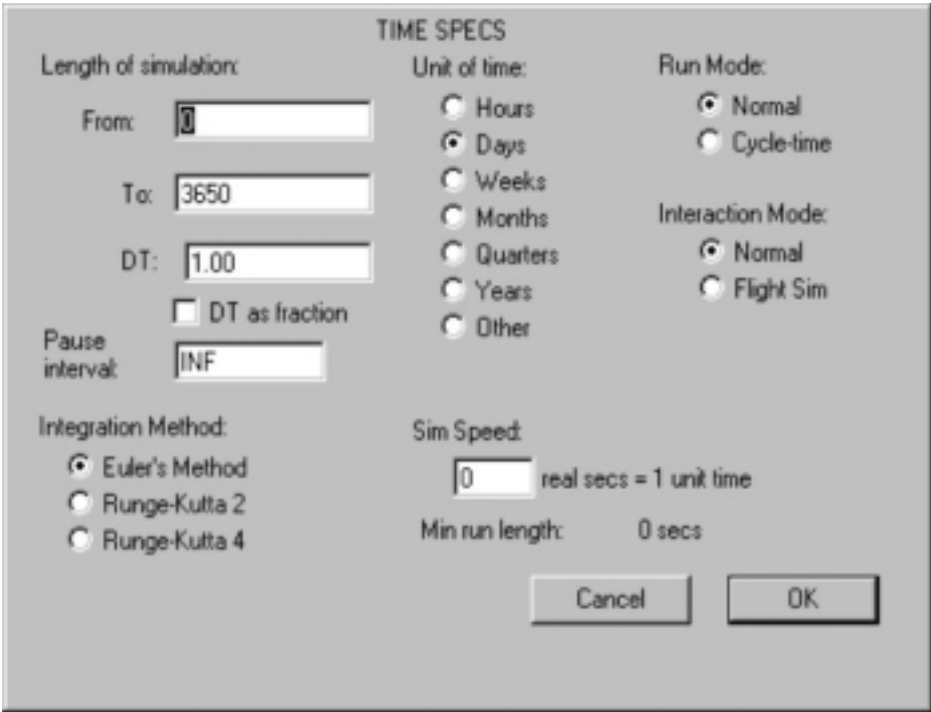

Figure App2.4. View of Time Specification screen

Output Result

There are two types of output result, (1) Tables and (2) Graphs.

To view a graph/table, click twice on the graph icon. What you will see is actually a stack of graphs/tables. To view the rest of graphs, click on the folded page at the bottom left corner.

When you look at graphs, notice that the scale on Y axis between parameters on the same graph can be different. Match the index number of parameters with index number of scales in Y axis.

Listed below is summary of available output on display. More detailed descriptions on output parameters are listed in Appendix 4 of this document.

A. GRAPHS

Overall: Summaries of overall zones and specific output related to Tree

Output	Content	Graph Type
Page 1	Plant biomass, tree biomass presence as total biomass	Time series
Page 2	Distribution of rainfall	Time series
Page 3	Distribution of cumulative amount of water drained out	Time series
Page 4-5	Distribution of cumulative amount of nutrient leached out	Time series
Page 6	Cumulative plant water uptake	Time series
Page 7	Total plant N & P uptake per day	Time series
Page 8-9	Amount of nutrient presence in plant aboveground biomass	Time series
Page 10	Water available, demanded and taken up by tree per day	Time series
Page 11-12	Nutrient available, demanded and taken up by tree per day	Time series
Page 13-15	Factors limiting tree growth	Time series
Page 16	C and Nutrient in SOM + litter pool	Time series
Page 17	Tree biomass and diameter	Time series
Page 18	Plant biomass, tree biomass presence as leaf and twig biomass	Time series
Page 19	Tree canopy biomass and cumulative pruned biomass	Time series
Page 20	Plant (Leaf and Twig) biomass	Histogram
Page 21	Water stock	Histogram
Page 22 - 23	Nutrient stock	Histogram
Page 24 - 25	Pore volume	Histogram

Zone 1, Zone 2, Zone 3, and Zone 4: Each of these graphs contain similar output parameter related to zone 1, 2, 3 and 4

Output	Content
Page 1	Factors limiting crop growth
Page 2	Distribution of water stock
Page 3-4	Distribution of nutrient in soil
Page 5	Distribution of crop water uptake
Page 6	Distribution of tree water uptake
Page 7,9	Distribution of crop nutrient uptake
Page 8,10	Distribution of tree nutrient uptake
Page 11-12	Nutrient available, demanded and taken up by crop per day

OilPalms: specific output for oilpalm

Output	Content
Page 1-3	Fruit biomass
Page 4	Biomass and oil harvested

Tree comp: specific output related to the tree phenology

Output	Content
Page 1	Tree Leaf Area Index (LAI)

B. TABLES

There is only one table containing 2 pages of water balance, plant biomass, water, N and SOM in soil.

Adding additional output parameters

To add more parameters to your tables or graphs do the following:

- o Click twice on your graph/table. After a graph/table appear, click twice again on it. Now, you will see a box emerge with 2 small boxes in the upper section. The left box contains parameters that can be loaded into graph/table. The right box contains parameters already in the graph/table. A graph can contain up to 5 parameters while a table can contain more than 40 parameters.
- o To load a parameter into the graph/table, highlight the parameter in **allowable** box then click an adjacent arrow pointing to the right.
- o If you want to load a parameter to a new clean page, prior to the above you need to click an arrow pointing upward at the bottom left corner pointing (**adjacent to Page**). Keep on clicking until you see **NEW** as page number.

Locking graphs or tables to speed your simulation

You can lock pages in your graphs and tables that you do not need. Locked graphs or tables will not be updated in the next simulation run. This would save a lot of time needed to run the model. To lock graph or table click on the lock icon. It is in the bottom left corner of your graph or on the top right corner of your table.

Printing your output

You can print your output by clicking on printer icon. It is in the bottom left corner of your graph or on the top right corner of your table. It will ask you to specify which page of your graph or table you want to print.

Importing Output Results

You can save your table as a text file and your graph as a pct file. You can also use copy (Ctrl-C) and paste (Ctrl-V) your output table. For graphs you can use screen dump (Shift-Print) then paste to your favourite Microsoft software.

To View Input-Output Summary

To view Input-Output Summary, click on button **TO RUN & OUTPUT SECTION** in the **Main Menu**. There are 7 input-output summary you can see, Water, Nitrogen, Phosphorus, Carbon, Financial & economic, Yield, Filter functions, Soil and Light. Choose the relevant one.

This screen gives you summary of input and output in the current system simulated. A list of parameters acronym found in this section is shown in **Appendix 4** under **Balance**.

Modifying Input Parameters

Click on button **'TO INPUT SECTION'** from **Main Menu**. It will lead you to list of input parameters.

Click again on button associated with specific parameters. Refer to **Appendix 7** in Documentation Manual for more detailed information on input parameters.

Basically data for WaNuLCAS model are placed in two locations, (1) the upper layer of the model and (2) WaNuLCAS.xls. When you click on input parameter button, it will either take to the actual input parameter location or inform you to enter it through Wanulcas.xls.

From upper layer of model there are basically three types of input device used, (1) list, (2) sliders and (3) graphical input

Changing Input Values

To modify input value just write over the current value. It will change if the new input value is within allowable range. If not, the maximum or minimum in the range will replace the value specified.

To check allowable value, please refer to Appendix 7 in documentation manual. If you experience problems, please let us know.

Please refer to Stella Technical Manual to change input values on specific input device.

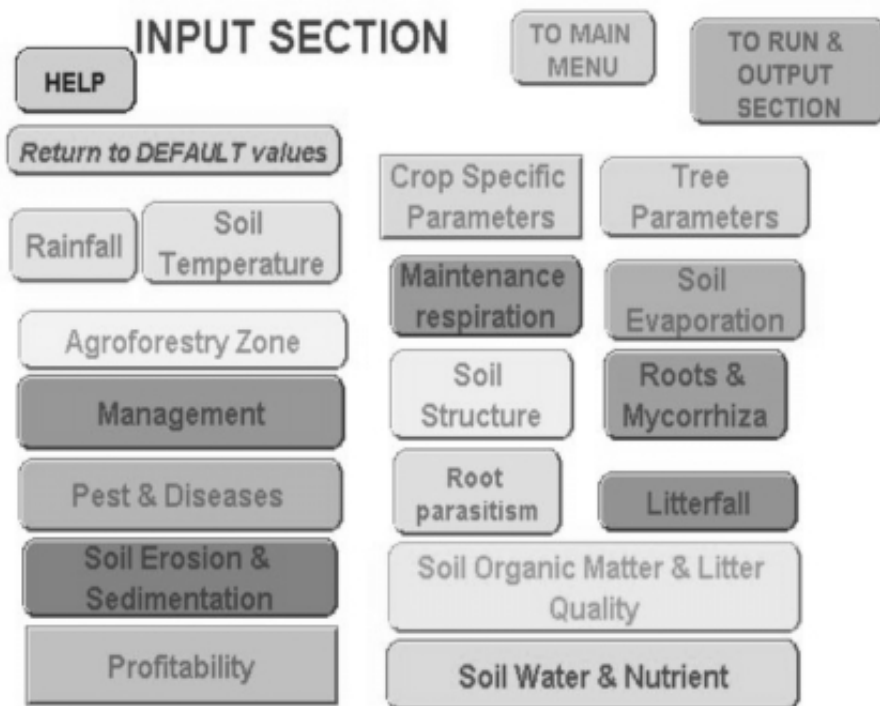

Figure App2.5. View of input menu

Description on Wanulcas.xls

This Excel file contains data used as input parameters and routines to help users in generating these input parameters. To be able to open the file you need at least Excel ver. 5.0 (MSOffice 97). The Excel must have Visual Basic Application as add-in working. The descriptions of each sheet are listed below.

All the sheets are protected by default in such a way that you will still be able to change input parameters. You can unprotect the sheets using password wanulcas (all lower case).

All input parameters in Wanulcas.xls are linked to WaNuLCAS model. For these parameters you should change it directly from the Excel sheet. For more detail description, please see Appendix 3.

Sheet	Content
READ ME	General information
Pedotransfer	Program to generate soil hydraulic properties. Output generated from this program forms data input for WaNuLCAS. These can automatically be copied to the sheet 'SOIL HYDRAULIC' where it is linked to WANuLCAS model.
Soil Hydraulic	Soil Hydraulic input parameters for each soil layer and zone. Linked to WaNuLCAS STELLA model
Phosphorus	Program to generate Ka (adsorption constant) of P, based on double Langmuir equation and related P_Bray to total mobile soil P content
Weather	Daily rainfall, daily soil temperature and daily potential evaporation
Slash and Burn	Slashing schedule and parameter impacts on the burning event
Crop Parameters/Library	Crop specific parameters
Tree Parameters/Library	Tree specific parameters
Crop Management	Planting schedule, fertilization schedule
Tree Management	Tree planting & timber harvesting schedule and pruning management.
Pedo SOM	Bulk density pedotransfer and Soil Organic Matter pedotransfer
Profitability	Input prices and labour requirement for the agroforestry system simulated and output produced.
Julian day	Information to converting calendar days per month into the 'day-of-year' (DOY) or 'Julian days' format used in the stella model
Link output	Information on how to make proper link between WaNuLCAS.xls and WaNuLCAS.stm and examples output that can get from WaNuLCAS simulation

Linking data

STELLA Research has a DDE facility, which enable users to link model to outside file.

Most of the contents of Wanulcas.xls are linked to WaNuLCAS model as input parameters. Linking enable you to change input value in WaNuLCAS by changing associated values in Wanulcas.xls. The linked values are marked by blue font.

When you open WaNuLCAS model in STELLA Research version, STELLA will ask if you want to establish link. Answer Yes if you want to have the model linked with Wanulcas.xls, but be sure that you already have EXCEL running in the background and Wanulcas.xls have already been copied.

STELLA only allows the changes to occur when both Excel and STELLA files are open simultaneously. Changes made in Excel prior to establishing the link will not change parameter values in STELLA. To overcome this problem we have built an updating macro in Excel. Run this macro by pressing Ctrl-u after you have the link between STELLA and Excel file establish to make sure all the input parameters value in STELLA model corresponds to the value in Excel.

With this macro, you will be able to have different excel files representing different parameterization. Rename the file to Wanulcas.xls when you want to use it. Click the updating macro. All the parameter values in Stella will be updated.

To Make Changes in the Model

There are 2 levels of model changes you can do; (1) change a constant parameter into a dynamic variable and (2) adding additional influencing parameter /factor to existing equations.

Changing a constant into dynamic variable

You can do this by making a constant parameter depends on existing-state variable. For example: change biomass-to-height conversion factor (Cq_HBiomConv[Cr]) into crop stage (Cq_Stage) dependent.

Adding influencing factor to existing equations

You can do this by adding additional parameter to existing equations. For example: add effect of slope as a parameter influencing potential evaporation (Evap_Pot).

Appendix 3

Description on Excel files accompanying WaNuLCAS model

The WaNuLCAS model is accompanied by 2 excel file; Wanulcas.xls and TreeParameterization.xls. Wanulcas.xls contains input parameters and routines to generate these input parameters. The input parameters are linked to WaNuLCAS model. See table in Appendix 2, page 149 for short descriptions of Wanulcas.xls content. TreeParameterization.xls is developed to generate input parameters for tree. There are several other help files to assist users in generating input parameters as well as better understand WaNuLCAS model. See our web page for more information.

Wanulcas.xls

The basic purpose of this Excel file is to ease users in modifying input parameters needed to run WaNuLCAS model. Input parameters in this file are linked to the model (in the WaNuLCAS.stm file).

There are two ways to change input parameters in excel, making sure changes also occur inside the model:

1. Change input values in excel ONLY if you run the model and excel simultaneously with links established, or
2. Change input values in excel before hand then save the file. When you run the model and establish links with excel later, make sure you press Ctrl-U, Ctrl-Y or Ctrl W. This is an updating macro built within this file, that re-activates the links and sends the current parameter values of the excel file to their counterparts in stella. The macro activated by Ctrl-U will update crop and tree parameters, the Ctrl-Y will update the soil and Ctrl W will update climate parameters.

The second option also allows you to store a number of parameter sets for specific locations under separate names (e.g. WanSite1.xls) and use them for simulations by renaming them to Wanulcas.xls and running the update macro's.

If in doubt whether parameters are actually sent across, you can open a table in Stella and ask to show (a sample of) the parameter values in the model and compare them with the input you expected to be used.

Below are comprehensive explanation of each sheet and the relevant WaNuLCAS input parameters are tabulated. Refer to Appendix 7 for definition of acronyms.

READ ME sheet

This is the main menu of Wanulcas.xls. It contains general information and button commands to browse other sheets.

Pedotransfer sheet

The 'Pedotransfer' sheet contains calculation tools to help generating tables of soil hydraulic parameters. The routine is based from Wösten et al. (1998).

You will need to enter 5 input parameters for basic soil properties in the 'Input' section of this sheet. The pedotransfer function then estimates the parameters of a Van Genuchten equation and tabulates the relations between soil water content, hydraulic conductivity and pressure head.

The saturated hydraulic conductivity Ksat generated in this equation is used as a default value, representing a soil with little structure and macroporosity. The model will use the KsatInit value that you specify yourself - if it differs from the default value it is possible to simulate a gradual collapse of soil structure (with a rate governed by S_KStructDecay, set at 0.001); macroporosity can be re-created by 'Worm' activity (see Section 3.3.6).

In WaNuLCAS two definitions of 'field capacity' are used to determine the maximum soil water content one day after a rainfall event:

- o Fieldcap1 = the soil water content (found in cell O11) at which downward drainage will become less than a small value Kcrit (set in cell B36 of the input section, e.g. 0.1 cm d-1), and
- o Fieldcap2 = the soil water content that is in hydrostatic equilibrium with a water table at a distance defined from the bottom of layer 4 (default distance is 0). This second value is calculated inside the Stella model.

For the actual calculations the highest of these two values for any cell is used.

The results generated by the pedotransfer routine are found in the 'Output' section of this sheet. These generated values are input parameters for WaNuLCAS model.

WaNuLCAS input parameters	Location in Excel
W_PhiTheta	cells N13 – N64
W_Ptheta	cells O13 – O64
W_PhiP (this is linked to 4 tables in the stella: W_PhiPH, W_PhiPMH, W_PhiPML, W_PhiP)	cells R13 – R64
W_ThetaPMax, W_ThetaP	cells U13 – U64
KsatDflt (default value, endpoint of loss of soil structure)	N11
Ksat (value used to initialize the model)	M11
Field Capacity1 (conductivity-limited)	O11

These input parameters need to be copied to the sheet 'Soil Hydraulic' properties. To copy the parameters for soil layer *i* and zone *j*, fill in *i* and *j* in cell N8 and N9 then click on the **COPY** button.

You can set up the model with the same properties for all zones and layers by repeating this for *i* = 1...4 and *j* = 1...4, modify the properties by layer or use different properties for any of the 16 cells.

Phosphorus sheet

The 'Phosphorus' sheet contains a procedure to calculate K_a_P , the apparent P adsorption constant as a function of the P concentration and P availability indices such as the P_{Bray} value. To run this, click on button **Psorption isotherm & Soil Database**. In this section you need to fill in the soil type for each layer of your soil in cells M8...M11. We provide default values for 9 soil types, as listed in U12....U20 If you have your own data, you can fill in parameters of a single or two-term Langmuir isotherm to describe your soil type. The parameters currently used for each soil layer are found in cells N8...R11. You also have to specify the bulk density of each layer (it is possible to use a value here that differs from the one used in the pedotransfer sheet...).

The parameters of the Langmuir sorption isotherm are used to derive values of K_a_P for each layer, tabulated in the '**P Sorption Output**' section of the worksheet. These values are linked to the WaNuLCAS.stm model.

This sheet also includes a section to initialize P in each cell (zone * layer), on the basis of indices of P availability such as the P_{Bray} value. To do this, you first have to specify two properties of the P availability index: the volume

ratio of soil to solution used during the extraction, and the relative sorption affinity in the extraction medium (at the temperature and other conditions used). For two methods we provide these parameters P-water (compare De Willigen and Van Noordwijk, 1987) and P-Bray (with a tentative, poorly tested estimate of the relative sorption affinity of 2% of the original value).

Once the method has been thus defined, click on '**Initial P Soil**' and fill in the initial P soil indices for each cell (AD8...AG11). The values will be converted to amount of soil P in the units expected in WaNuLCAS.stm in cells (AD14...AG17). These converted values are linked to the Stella model.

WaNuLCAS input parameters	Location
Initial P in soil, N_Init/[P,Zone]; $i = 1, \dots, 4$	cells AC14 – AF17
N_KaPDef[Layer]	cells C93 – C143, E93 – E143, G93 – G143, I934 – I143

Weather sheet

This sheet stores daily data for 3 weather components in WaNuLCAS: Rainfall, Soil Temperature and Potential Evaporation. Default length of data and links are 1 year (365 days). These data are linked.

WaNuLCAS input parameters	Location
Rain_Data	cells C5 – C369
Temp_DailyData	cells D5 – D369
Temp_DailyPotEvap	cells E5 – E369

Slash&Burn sheet

This sheet holds input parameters related to impacts of slash and burn on soil as a function of increased temperature at the soil surface.

WaNuLCAS input parameters	Location
S&B_SurfLitBurnFrac	cells B12 – B26
S&B_NecroBurnFrac	cells C12 – C26
S&B_DeadWoodBurnFrac	cells D12 – D26
S&B_AerosolFrac	cells E12 – E26
S&B_NvolatFrac	cells F12 – F26
S&B_PvolatFrac	cells G12 – G26
S&B_SOMBurnFrac	cells J12 – J19
S&B_FirMortSeedBank	cells K12 – K19
S&B_FirIndPMobiliz	cells L12 – L19
S&B_FirImpPSorption	cells O12 – O26

Crop Management sheet

This sheet holds a schedule for planting crops (by zone and type) and applying N or P fertilizers. The current simulation year is defined as YEAR 0.

In this sheet you will be able to define the type of crop you plan to use in the simulation. In cell B2-F2 fill the letter code of crop type associated with the code in the database. It is written as options on the left hand side or see sheet **CROP LIBRARY**. The type of crop you choose here determine the parameter values copied to sheet **CROP PARAMETERS** and **PROFITABILITY**, where the values are linked to model.

WaNuLCAS input parameters	Location
Ca_PlantYear[Zone]	cells B11 – B31, G11 – G31, L11 – L31, Q11 – Q31
Ca_PlantDoY[Zone]	cells C11 – C31, H11 – H31, M11 – M31, R11 – R31
Ca_CType[Zone]	cells D11 – D31, I11 – I31, N11 – N31, S11 – S31
Ca_FertOrExtOrgAppYear	cells V11 – V51
Ca_FertOrExtOrgAppDoY	cells W11 – W51
Ca_FertApply?[SINut]	cells X11 – X51, Y11 – Y51
Ca_ExtOrgApply?[Type]	cells Z11 – Z51, AA11 – AA51
Ca_FertOrExtOrgAmount[Zone] []	cells AB11 – AB51, AC11 – AC51, AD11 – AD51, AE11 – AE51

You have a maximum of 5 different crop type to grow in one simulation. The letter code you fill in here will be converted to crop type value of 1 to 5, which you will use as input parameter in column **D**, **I**, **N** and **S**.

Tree Management sheet

This sheet holds a schedule for tree planting, pruning and timber harvesting. As in **CROP MANAGEMENT** the current simulation year is defined as YEAR 0.

This where you define the type of tree you plan to use in the simulation. In cell E4-G4 fill the letter code of tree type associated with the code in the database. It is written as options on the left hand side or see sheet **TREE LIBRARY**. The type of crop you choose here determine the parameter values copied to sheet **TREE PARAMETERS** and **PROFITABILITY**, where the values are linked to model.

It is possible to grow 3 different tree type simultaneously.

WaNuLCAS input parameters	Location
T_PlantY[Tree]	cells C11 – C31, E11 – E31, G11 – G31
T_PlantDoY[Tree]	cells D11 – D31, F11 – F31, H11 – H31
T_PrunY	cells K11 – K51
T_PrunDoY	cells L11 – L51
T_PrunFracD[Tree]	cells M11 – M51, O11 – O51, Q11 – Q51
T_PrunHarvFracD[Tree]	cells N11 – N51, P11 – P51, R11 – R51
T_WoodHarvY[Tree]	cells C37 – C57, E37 – E57, G37 – G57
T_WoodHarvDoY[Tree]	cells D37 – D57, F37 – F57, H37 – H57

Crop Library sheet

This sheet holds a database for crop specific parameters and crop related input-output for the system simulated. Overall there are 58 input parameters including 5 growth parameters as a function of crop stage. Some parameters are only required for specific settings in the simulation, e.g. there are three mutually exclusive ways of determining root length density in each cell in each time step, as governed by C_RootType.

Currently there are 10 possible type of crops in the database. For 5 of them we have provided default values, that is for crop Cassava, Maize, Upland Rice, Groundnut and Cowpea. If you have your own data you can fill your data values under crop type Yours1, ..., Yours5. For the whole list of input parameters stored, please refer directly to the excel sheet.

To choose the type of crop you use in simulation fill in relevant cell in sheet CROP MANAGEMENT.

Tree Library sheet

This sheet holds tree specific parameters. There are 95 input parameters. As in crop specific parameters, some inputs are only required if you run certain type of simulations.

All you need to fill in this sheet is the letter code of tree type (cell E8 - G9) associated with the code in the database. You have a maximum of 3 different tree type grow simultaneously in one simulation. The tree type you fill in is link to **PROFITABILITY** sheet

In the database we have so far provided only 2 default values for the trees *Gliricidia sepium* and *Peltophorum dasyrrachis*. If you have your own data you can fill in this value into the database (see cell L6).

For the whole list of input parameters stored, please refer directly to the excel sheet.

Soil Hydraulic sheet

This sheet contains soil hydraulic input parameters as generated and copied from Pedotransfer sheet. The cells here are linked to the WaNuLCAS model. There are no user inputs required here, as all input is generated by the pedotransfer sheet. You can, however, check that the COPY command has lead to the expected results or not.

Profitability sheet

The sheet contains input needed in the simulated systems and output produced. There are basically 3 categories of input, for the whole field, trees and crops. Input for the whole field you will need to fill in this sheet, while for plant input it is filled in database TREE/CROP LIBRARY

See directly in the excel sheet the whole list of input parameters.

Tree parameterization.xls

This file for generate input parameters in tree library in WaNuLCAS.xls. Below are the detail explanation for each sheet carried out.

Main sheet, this sheet is the main menu of tree parameterization.xls which is conducted in to two parts tree survey and FBA model. Tree survey is more for estimate the tree specific parameter while FBA model for estimate allometric branching for WaNuLCAS. It contains general information and button commands to browse tree survey and FBA model.

Survey sheet, this sheet contains 39 question that split in to 10 categories, growth stage, growth, canopy, light capture, rain interception, tree water, N fixation, N and P concentration, litterfall and litterquality. Users may answer all questions or only some of those related to the certain category.

WaNuLCAS sheet, while user answer the question on sheet survey, the input parameter for WaNuLCAS.xls (tree library sheet) will be automatically estimated on this sheet, later user can copy the result from this sheet to the tree library sheet.

WanFBA sheet, all input that needed to run FBA model are prepared on this sheet based on the observational data in the field. The input are needed split in to 4 categories, information of branching pattern, information of tree size, information of woody part and information of final links.

Input sheet, when user had finished fill in all the information, with 'Ctrl H' will be automatically estimated all input that needed to run the FBA model on this sheet, and 'Ctrl R' will be automatically estimated biomass allometric equation for each part (total biomass, wood, leaf and twig and litterfall). The biomass allometric equation will be automatically copied on sheet WaNuLCAS.

Sumoutput sheet, the sumoutput shows not only allometric equation but also all the important information that can be obtained from this program.

Estimate sheet, this sheet contains estimate input for WanFBA input compared to the default value.

Appendix 4

List of Output Acronyms and Definition

No.	Acronym	Definition
1.	AF	"Agroforestry Zone" - overall design on the system
2.	B	Balance (carbon=BC, nutrient=BN, BS=Soil or water=BW)
3.	C	Crop (C = Crop, C_N = Crop Nutrient or CW = Crop Water)
4.	E	Erosion
5.	Light	Light
6.	P	Profitability (economic sector of the model)
7.	Rain	Rain
8.	T	Tree (T = Tree, T_N = Tree Nutrient or TW = Tree Water)
9.	TF	Oil Palm

No	Acronym	Definition	Units	Location
1.	AF_DepthLay1	Initial soil thickness in layer 1	m	Soil Balance
2.	B_T_HarvCum [DW,Tree]	Cumulative biomass harvested from each type of tree	kg m ⁻²	Yield
3.	BC_CO2FromBurn	Cumulative amount of carbon released into air from burning event	g m ⁻²	Carbon Balance
4.	BC_CPhotosynth	Amount of carbon produced by crop through photosynthesis	g m ⁻²	Carbon Balance
5.	BC_CRespforFix	Amount of carbon released by crop due to respiration needed for N fixation	g m ⁻²	Carbon Balance
6.	BC_Crop	Amount of carbon currently presence as crop biomass	g m ⁻²	Carbon Balance
7.	BC_Croplnit	Initial amount of carbon presence as crop biomass	g m ⁻²	Carbon Balance
8.	BC_ExtOrgInput	Amount of carbon in external organic input eg. mulch	g m ⁻²	Carbon Balance

No	Acronym	Definition	Units	Location
9.	BC_CStockInit	Initial amount of carbon in soil organic matter and surface litter pools and tree	g m ⁻²	Carbon Balance
10.	BC_CurrentCStock	Current amount of carbon in soil organic matter, surface litter pools, tree, crop, necromass and weed	g m ⁻²	Carbon Balance
11.	BC_ExtOrgInput	Amount of carbon in external organic input eg. mulch	g m ⁻²	Carbon Balance
12.	BC_GWEffectCO2	Net global warming effect in g CO ₂ equivalent per m ² over duration of the simulation	g m ⁻²	Carbon Balance
13.	BC_HarvestedC	Amount of carbon in harvested crop/yield (average over total field length)	g m ⁻²	Carbon Balance
14.	BC_HarvestedT	Amount of carbon in harvested component of tree	g m ⁻²	Carbon Balance
15.	BC_Inflows	Total amount of carbon entered the systems through tree and crop photosynthesis, initial tree and crop biomass and weed	g m ⁻²	Carbon Balance
16.	BC_NecromassC	Amount of carbon as necromass	g m ⁻²	Carbon Balance
17.	BC_NetBal	Balance value for carbon. It is used to check model calculation and should be (virtually) 0	g m ⁻²	Carbon Balance
18.	BC_Outflows	Current amount of carbon losses from the system through crop harvested, component of tree harvested and carbon respired	g m ⁻²	Carbon Balance
19.	BC_SOM	Current amount of carbon in soil organic matter and surface litter pools	g m ⁻²	Carbon Balance Graph Overall (16)
20.	BC_SOMInit	Initial amount of carbon in soil organic matter and surface litter pools	g m ⁻²	Carbon Balance
21.	BC_TimeAvgCStock	Total amount of carbon in the whole system averaged over the simulation period	g m ⁻²	Carbon Balance
22.	BC_TotalRespired	Total carbon respired	g m ⁻²	Carbon Balance
23.	BC_Tphotosynth	Amount of carbon produced by tree through photosynthesis	g m ⁻²	Carbon Balance
24.	BC_Tree	Current amount of carbon in tree biomass	g m ⁻²	Carbon Balance

No	Acronym	Definition	Units	Location
25.	BC_TreeInnitTot	Total amount of carbon initialized as tree biomass	g m ⁻²	Carbon Balance
26.	BC_TRespforFix	Amount of carbon released by crop resulted from respiration for N fixation	g m ⁻²	Carbon Balance
27.	BC_Weed	Amount of carbon currently presence as weed	g m ⁻²	Carbon Balance
28.	BC_WeedSeeds	Amount of carbon as seeds of weed	g m ⁻²	Carbon Balance
29.	BN_CBiominit [SINut]	Initial amount of nutrient in crop biomass	g m ⁻²	N Balance, P Balance
30.	BN_CHarvCum [SINut]	Amount of nutrient in harvested crop/yield (average over whole field)	g m ⁻²	N Balance, P Balance
31.	BN_CNdfaFrac	Fraction of N derived from fixation by all crop	dimen- sionless	Yield
32.	BN_CNFixCum	Total amount of N fixed by crop	g m ⁻²	N Balance
33.	BN_CropBiom [SINut]	Current amount of nutrient (N or P) in crop biomass (average over total field length)	g m ⁻²	Graph Overall (8 - 9)
34.	BN_CropBiom [SINut]	Current amount of nutrient in tree biomass	g m ⁻²	N Balance, P Balance, Graph Overall, (8 - 9)
35.	BN_CUptTot [SINut]	Total amount of nutrient taken up by crop (average over total field length)	g m ⁻²	Graph Overall, (7)
36.	BN_EffluxTot [SINut]	Current amount of nutrient loss from the system through crop harvested, leaching, surface run off, etc	g m ⁻²	N Balance
37.	BN_ExtOrgInputs [SINut]	Total amount of nutrient entered the system from external organic input	g m ⁻²	N Balance, P Balance
38.	BN_FertCum [SINut]	Cumulative amount of fertilizer input (average over total field length)	g m ⁻²	N Balance, P Balance
39.	BN_Immob[SINut]	Current amount of nutrient in immobile pool	g m ⁻²	N Balance, P Balance
40.	BN_ImmPool [SINut]	Initial amount nutrient in immobile pool	g m ⁻²	N Balance, P Balance
41.	BN_InfluxTot [SINut]	Total amount of nutrient entered the system from initial crop biomass, fertilizer, external organic input, etc	g m ⁻²	N Balance
42.	BN_LatInCum [SINut]	Nutrient input due to lateral flow	g m ⁻²	N Balance, P Balance

No	Acronym	Definition	Units	Location
43.	BN_LatOutCum [SINut]	Amount nutrient flows out due to lateral flow	g m ⁻²	N Balance, P Balance
44.	BN_LeachingTot [SINut]	Total amount of nutrient leached out from bottom layers (average over total field length)	g m ⁻²	N Balance, P Balance
45.	BN_Lit[SINut]	Current amount of nutrient in litter layer	g m ⁻²	N Balance, P Balance
46.	BN_LitInit[SINut]	Initial amount of nutrient in litter layer	g m ⁻²	N Balance, P Balance
47.	BN_NetBal[SINut]	Balance value for nutrient. It is used to check model calculation and should be (virtually) 0	g m ⁻²	N Balance, P Balance
48.	BN_NutVolatCum [SINut]	Total amount of carbon volatilized from burnt necromass	g m ⁻²	N Balance, P Balance
49.	BN_SOM[SINut]	Current amount of nutrient in soil organic matter pool	g m ⁻²	N Balance, P Balance, Graph Overall (16)
50.	BN_SOMInit[SINut]	Initial amount of nutrient in soil organic matter pool	g m ⁻²	N Balance, P Balance
51.	BN_StockInit [SINut]	Initial amount of nutrient (average over all zones and layers)	g m ⁻²	N Balance, P Balance
52.	BN_StockTotInit [SINut]	Total amount of initial soil nutrient	g m ⁻²	N Balance, P Balance
53.	BN_StockTot [SINut]	Current amount of nutrient in soil (average over all zones and layers)	g m ⁻²	N Balance, P Balance
54.	BN_THarvCumAll [SINut]	Amount of nutrient in biomass harvested from tree (average over total field length)	g m ⁻²	N Balance, P Balance
55.	BN_TNdfaFrac	Fraction of N derived from fixation by tree	dimensionless	Yield
56.	BN_TNFixAmount Cum	Total amount of N fixed by crop	g m ⁻²	N Balance
57.	BN_Treelnit[SINut]	Initial amount of nutrient in tree biomass	g m ⁻²	N Balance, P Balance
58.	BN_WeedBiom [SINut]	Current amount of nutrient in weed biomass	g m ⁻²	N Balance, P Balance
59.	BN_WeedSeed Bank [SINut]	Current amount of nutrient in seedbank	g m ⁻²	N Balance, P Balance
60.	BN_WeedSeedInit [SINut]	Initial amount of nutrient in seedbank	g m ⁻²	N Balance, P Balance

No	Acronym	Definition	Units	Location
61.	BS_SoilCurr	Current amount of soil	kg m ⁻²	Soil Balance
62.	BS_SoilDelta	Overall balance of input and output of soil in the model. A value of 0 means that the model calculation is in balance.	kg m ⁻²	Soil Balance
63.	BS_SoilInflowcum	Total amount of soil inflow	kg m ⁻²	Soil Balance
64.	BS_SoilInit	Initial amount of soil	kg m ⁻²	Soil Balance
65.	BS_SoilLossCum	Total amount of soil loss	kg m ⁻²	Soil Balance
66.	BW_DrainCumV	Total amount of water draining (average over all zones and layers)	l m ⁻²	Water Balance
67.	BW_EvapCum	Total amount of water evaporates from soil surface (average over all zones and layers)	l m ⁻²	Water Balance
68.	BW_LatInCum	Amount of lateral inflow (subsurface) of water	l m ⁻²	Water Balance
69.	BW_LatOutCum	Amount of lateral outflow (subsurface) of water	l m ⁻²	Water Balance, Graph Overall (3)
70.	BW_NetBal	Overall balance of input and output of water in the model. A value of 0 means that the model calculation is in balance.	l m ⁻²	Water Balance, Graph Overall (10)
71.	BW_RunOffCum	Amount of (surface) run off water	l m ⁻²	Water Balance
72.	BW_RunOnCum	Amount of (surface) run on water	l m ⁻²	Water Balance
73.	BW_StockInit	Initial total amount of water in all layers and zones of soil	l m ⁻²	Water Balance
74.	BW_StockTot	Current total amount of water in soil profile	l m ⁻²	Water Balance
75.	BW_UptCCum	Cumulative amount of water uptake by crop	l m ⁻²	Water Balance, Graph Overall (6)
76.	BW_UptTCum [Tree]	Cumulative water uptake by each tree	l m ⁻²	Water Balance Graph Overall (6)
77.	C_AgronYields [Crop]	Agronomic yield for each type of crop	kg m ⁻²	Yield
78.	C_Biom[Zone,DW]	Current crop biomass in each zone (including canopy, storage, roots)	kg m ⁻²	Graph Overall (1), Graph Zone <i>i</i> (1)

No	Acronym	Definition	Units	Location
79.	C_BiomCan[Zone, DW]	Current crop canopy biomass in each zone	kg m ⁻²	Graph Overall (18)
80.	C_FracLim[LimFac]	Average value over the simulation for each limiting factor for crop growth, value between 0 and 1	-	Yield
81.	C_NDemand[Zone]	Amount of nutrient demanded by crop in each zone	kg m ⁻²	Graph Zone <i>i</i> (11 - 12)
82.	C_NPosGro [Zone, SINut]	The effect of nutrient stress on crop growth (0=no growth, 1=no stress)	dimensionless	Graph Zone <i>i</i> (1)
83.	C_NUptPot[Zone]	Amount of nutrient available for crop uptake in each zone	g m ⁻²	Graph Zone <i>i</i> (11 - 12)
84.	C_NUptTot[Zone]	Amount of nutrient uptake by crop in each zone	g m ⁻² day ⁻¹	Graph Zone <i>i</i> (11 - 12)
85.	Cent_BalTotal [SINut]	Overall balance of input and output in mineralization module (adapted from CENTURY model). A value of 0 means that model calculations are in balance	g m ⁻²	N Balance, P Balance
86.	CW_PosGro[Zone]	The effect of water stress on crop growth in each zone (0=no growth, 1=no stress)	dimensionless	Graph Zone <i>i</i> (1)
87.	E_TopSoilDepthAct [Zone]	Current soil thickness in layer 1	m	Soil Balance
88.	GHG_CumCH4 Emission	Cumulative emission of CH ₄	g m ⁻²	N Balance
89.	GHG_GWP_N2O& CH4	Global Warming Potential of the systems based on the emission of CH ₄ and NO ₂ . It is expressed relative to CO ₂	-	N Balance
90.	GHG_N2_Fraction	Fraction of N ₂ emission	dimensionless	N Balance
91.	GHG_NO_Fraction	Fraction of NO emission	dimensionless	N Balance
92.	GHG_N2O_Fraction	Fraction of N ₂ O emission	dimensionless	N Balance
93.	Light_CRelCap [Zone]	Relative light capture by crop (on scale 0-1)	g m ⁻²	Graph Zone <i>i</i> (1)
94.	Light_CRelSupply [Zone]	Potential crop growth limited by light capture relative to the potential without presence of trees (1 = no limitation, 0 = no growth)	-	Light
95.	N_CumAtmInput [SINut]	Amount of nutrient derived from atmospheric deposition	g m ⁻²	N Balance, P Balance

No	Acronym	Definition	Units	Location
96.	N_CUpt/ <i>i</i> [Zone, SINut]	Amount of nutrient uptake by crop from <i>i</i> -th soil layer of each zone per day	g m ⁻² day ⁻¹	Graph Zone/ <i>i</i> (7, 9)
97.	N_EdgeFFH[SINut]	A value describing filter function horizontally at the edge of plot	dimensionless	Filter Function
98.	N_EdgeFFV[SINut]	A value describing filter function vertically at the edge of plot	dimensionless	Filter Function
99.	N_LeachCumV [Zone, SINut]	Total amount of nutrient leached out from bottom layer of each zone	g m ⁻²	Graph Overall (4 - 5)
100.	N_Leach/ <i>i</i> [Zone, SINut]	Amount of nutrient leached out from <i>i</i> -th layer of each zone	g m ⁻²	Graph Zone/ <i>i</i> (13 - 14)
101.	N_LocFF3/ <i>i</i> [SINut]	A value describing filter function in the 3rd layer of soil	dimensionless	Filter Function
102.	N_Stock/ <i>i</i> [Zone, SINut]	Amount of nutrient stock in each zone of layer <i>i</i>	g m ⁻²	Graph Zone/ <i>i</i> (3, 4)
103.	N_TotFFTot[SINut]	A value describing how the whole system function as a filter. Filter function defined as nutrient taken up by plant divided by total nutrient taken up and loss	dimensionless	Filter Function
104.	N_TUpt/ <i>i</i> [Zone, SINut]	Amount of nutrient taken up by tree from <i>i</i> -th soil layer of each zone per day	g m ⁻² day ⁻¹	Graph Zone/ <i>i</i> (8, 10)
105.	P_CCostAvg[Price]	Average cost of crop management	currency unit ha ⁻¹	Economic & Financial Balance
106.	P_CReturnAvg [Price]	Amount of money contributed from crop production	currency unit ha ⁻¹	Economic & Financial Balance, Yield
107.	P_CumLabUse	Total amount of labour use to manage the system	man days	Yield
108.	P_GeneralCost [Price]	Total cost needed to maintain the system	currency unit ha ⁻¹	Economic & Financial Balance
109.	P_NPV[Price]	Net present value of the system	currency unit ha ⁻¹	Economic & Financial Balance
110.	P_TCostTot[Price]	Total cost of crop management	currency unit ha ⁻¹	Economic & Financial Balance
111.	P_TReturn[Price]	Amount of money contributed from tree production	currency unit ha ⁻¹	Yield
112.	P_TReturnTot [Price]	Total amount of money contributed from tree production	currency unit ha ⁻¹	Economic & Financial Balance, Yield

No	Acronym	Definition	Units	Location
113.	Rain	Amount of rain per day	$l\ m^{-2}\ day^{-1}$	Graph Overall (2)
114.	Rain_Cum	Cumulative amount of rainfall	$l\ m^{-2}$	Water Balance, Table 1 (1)
115.	Rain_In[Zone]	Actual amount of rain going into each zone	$l\ m^{-2}\ day^{-1}$	Graph Overall (2), Table 1 (1)
116.	Rain_IntercEvapCum	Amount of water evaporated from intercepted water	$l\ m^{-2}$	Water Balance
117.	T_Biom[Tree]	Current amount of biomass for each tree (above and belowground)	$kg\ m^{-2}$	Graph Overall (1)
118.	T_BiomCumTot	Total cumulative amount of tree biomass (including litterfall, rootdecay, harvested pruning)	$kg\ m^{-2}$	Yield
119.	T_CumLatexHarv[Tree]	Total latex harvested	$kg\ m^{-2}$	Yield
120.	T_FracLim[Tree, LimFrac]	Average value over the simulation for each limiting factor for tree growth, value between 0 and 1	dimensionless	Yield
121.	T_FruitHarvCum[Tree]	Total fruit harvested	$kg\ m^{-2}$	Yield
122.	T_GroRes[Tree]	Current amount of biomass in tree growth reserves	$kg\ m^{-2}$	Graph Overall (17)
123.	T_LAI[Tree]	Tree Leaf Area Index	dimensionless	Graph Tree Comp
124.	T_LfTwig[Tree]	Current amount of biomass in tree canopy	$kg\ m^{-2}$	Graph Overall (17, 18, 19)
125.	T_Light[Tree]	Fraction of light received by tree	dimensionless	Graph Overall (13 - 15)
126.	T_NBiom[SINut, Tree]	Current amount of nutrient in tree aboveground biomass	$g\ m^{-2}$	N Balance, P Balance, Graph Overall (8 - 9)
127.	T_NDemandAll[SINut]	Amount of nutrient demanded by tree per day	$g\ m^{-2}\ day^{-1}$	Graph Overall (11 - 12)
128.	T_NfixCum[SINut, Tree]	Cumulative amount of nutrient derived from fixation by tree	$g\ m^{-2}$	N Balance
129.	T_NPosgro[SINut]	The effect of nutrient stress on tree growth (0=no growth, 1=no stress)	dimensionless	Graph Overall (13 - 15)
130.	T_NUptPotAll[SINut]	Total amount of nutrient in all soil layers available for tree per day	$g\ m^{-2}\ day^{-1}$	Graph Overall (11 - 12)

No	Acronym	Definition	Units	Location
131.	T_NUptTotAll [SINut]	Total amount of nutrient taken up by tree (average over total field length)	$\text{g m}^{-2} \text{ day}^{-1}$	Graph Overall (7, 11 - 12)
132.	T_Root[Tree]	Current amount of tree root biomass	kg m^{-2}	Graph Overall (17)
133.	T_StemDMax	Stem diameter of tree	m	Graph Overall (17)
134.	T_Wood	Current wood/stem biomass	kg m^{-2}	Graph Overall (17)
135.	T_WoodHarvCum [Tree]	Total timber/wood harvested	kg m^{-2}	Yield
136.	TF_BunchWeight [Tree, FruitBunch]	Total weight of oil palm fruit per fruit stages	kg m^{-2}	Graph OilPalm
137.	TF_CumFruitHarv [Tree]	Cumulative amount of oil palm fruit harvested	kg m^{-2}	Graph OilPalm
138.	TF_CumOilHarvest [Tree]	Cumulative amount of oil harvested	kg m^{-2}	Graph OilPalm
139.	TF_FemBunchFrac [Tree]	Fraction of female flowers/fruit	kg m^{-2}	Graph OilPalm
140.	TF_FruitperBunch [Tree, FruitBunch]	Number of oil palm fruit per fruit stages	kg m^{-2}	Graph OilPalm
141.	TF_WatNutSuff [Tree]	The effect of water and nutrient stress on the oilpalm growth	dimensionless	Graph OilPalm
142.	TW_DemandActAll	Amount of water demanded by all tree per day	$\text{l m}^{-2} \text{ day}^{-1}$	Graph Overall (10)
143.	TW_Posgro[Tree]	The effect of water stress on tree growth (0=no growth, 1=no stress)	dimensionless	Graph Overall (10, 13 - 15)
144.	TW_UptPotAll	Total amount of water in all soil layers available for tree per day	$\text{l m}^{-2} \text{ day}^{-1}$	Graph Overall (10)
145.	TW_UptTotAll	Current amount of water uptake by tree from all soil layers per day	$\text{l m}^{-2} \text{ day}^{-1}$	Graph Overall (10)
146.	W_CUpt/[Zone]	Amount of water taken up by crop from <i>i</i> -th soil layer of each zone per day	$\text{l m}^{-2} \text{ day}^{-1}$	Graph Zone/ <i>i</i> (5)
147.	W_DrainCumV [Zone]	Cumulative amount of water drained out from bottom layer	l m^{-2}	Graph Overall (3)
148.	W_Stock/[Zone]	Amount of water each zone in <i>i</i> -th soil layer	l m^{-2}	Graph Zone/ <i>i</i> (2)
149.	W_TUpt/[Zone]	Amount of water taken up by all tree from <i>i</i> -th soil layer of each zone per day	$\text{l m}^{-2} \text{ day}^{-1}$	Graph Zone/ <i>i</i> (6)

Appendix 5

Deriving uptake equation (P. de Willigen)

According to De Willigen and Van Noordwijk (1987 - Table 9.1, equ. 12.9) uptake rate is given by:

$$\frac{\rho^2 \Theta \beta}{2\phi\eta} = \frac{(\rho^2 - 1)\bar{c}}{2G(\rho)} \quad [\text{A1}]$$

Now (l.c. page 125):

$$G(\rho) = \frac{1}{2} \left\{ \frac{1 - 3\rho^2}{4} + \frac{\rho^4 \ln \rho}{\rho^2 - 1} \right\} \quad [\text{A2}]$$

As normally $\rho \ll 1$

$$G(\rho) \approx \rho^2 \left(-\frac{3}{8} + \frac{1}{2} \ln \rho \right) \quad [\text{A3}]$$

The parameters ρ 1, ϕ 2 and η 3 are given by:

$$\begin{aligned} \rho &= \frac{R_l}{R_o} & 1 \\ \phi &= \frac{D S_i}{U R_o} = \frac{D \theta \beta C_i}{U R_o} & 2 \\ \eta &= \frac{H}{R_o} & 3 \end{aligned} \quad [\text{A4}]$$

and the dimensionless concentration by:

$$\bar{c} = \frac{C}{C_i} \quad [\text{A5}]$$

where D is the diffusion coefficient (m².d⁻¹), H is the thickness of the soil layer (m), U is the uptake rate (g.m⁻².d⁻¹), R₀ the radius of the root (m) and R₁ the radius of the soil cylinder surrounding the root. The latter is given by:

$$R_1 = \frac{I}{\sqrt{\pi L_{rv}}} \quad [\text{A6}]$$

The parameter 4 denotes the buffer power of the soil. Substitution of (A2)-(A6) into (A1) leads to:

$$U = \frac{D\bar{C}H}{R_0^2 \left(-\frac{3}{8} + \frac{1}{2} \ln \rho \right)} \quad [\text{A7}]$$

The diffusion coefficient is a function of the water content Θ , according to:

$$D = (a_1 \Theta + a_0) \Theta D_0 \quad [\text{A8}]$$

where D₀ is the diffusion coefficient of the nutrient in question in water, whereas the concentration can be calculated from the amount in the layer N_{stock} (g.m⁻²):

$$C = \frac{N_{stock}}{K_a + \Theta} \quad [\text{A9}]$$

K_a being the adsorption constant. Substitution of (A2)-(A9) into (A1) ultimately yields (A10) which is the basis for equation (10) in WaNuLCAS.

$$U = \frac{\pi D_0 (a_1 \Theta + a_0) \Theta H N_{stock}}{(K_a + \Theta) \left[-\frac{3}{8} + \frac{1}{2} \ln \left\{ \frac{I}{R_0 \sqrt{\pi L_{rv}}} \right\} \right]} \quad [\text{A10}]$$

Appendix 6

Trouble-shooting and Tips

As for any complex system, the number of ways in which the model can go wrong is nearly infinite, while there is only one (or a few) ways it can go right. So the odds certainly are against us. If things go wrong, however, there are a number of ways to identify the source of the errors as a step towards mending it.

Difficulties in loading the files:

- o Links can not be established: check whether you have indeed opened the right XLS file and have not changed the position of any of the linked parameters by adding or deleting rows or columns or moving cell contents around,
- o Low Memory ('cannot continue DDE conversation'); it may help to remove all memory demanding programs, including net-work links and microsoft office toolbars from the memory; sometimes it helps to re-boot the computer and start afresh; this type of error message may occur when you update the links by running the Ctrl+Y, Ctrl+W or Ctrl+U macro in the excel; if the problem persists you'll have to get more RAM on your computer (32 MB is a bare minimum); you can also make runs in the Stella model without opening the excel + links, or close the excel file after updating parameter values, to increase the memory allocation for the Stella model.
- o Running speed can be increased by locking graphs/tables that you're not currently interested in.
- o Links are not working; WaNuLCAS.xls is developed using MS Excel with English language as the settings. If you use MS Excel with settings on other languages the link will not work. You will need to modify the links within the model (WaNuLCAS.stm) using STELLA version 6 or above.

Error message at start or during RUN

It is possible that when you press RUN you get an error message, instead of output. The message will indicate a parameter name and the error usually consists of division by zero. We have tried to protect all equations from such an event, but if necessary you can add an 'If *** <> 0 then '...existing equation...' else 0' statement to the equation involved, with the *** replaced by any divisor in the equation.

Numeric Display

?

Rain Cum

336.0

STELLA 5.1.1

File Edit Map Run Help

Table.TXT

10:57 AM Wed, Apr 07, 2004 Table 1: p3 (Table.TXT)

Days	C Run(Dv)	C Run(Dv)	C Run(Dv)	C Run(Dv)
88	0.00000	0.219994	0.219940	0.219951
89	0.00000	0.233467	0.233405	0.233444
100	0.00000	0.247170	0.247148	0.247167
101	0.00000	0.251087	0.251065	0.251074
102	0.00000	0.275195	0.275172	0.275182
103	0.00000	0.299481	0.299459	0.299469
104	0.00000	0.303635	0.303612	0.303622
105	0.00000	0.318671	0.318648	0.318658
106	0.00000	0.333382	0.333359	0.333369
107	0.00000	0.348350	0.348327	0.348337
108	0.00000	0.353502	0.353479	0.353489
109	0.00000	0.378802	0.378779	0.378789
110	0.00000	0.394257	0.394234	0.394243
111	0.00000	0.409954	0.409931	0.409941
112	0.00000	0.425919	0.425896	0.425906
113	0.00000	0.442122	0.442099	0.442109
114	0.00000	0.458570	0.458547	0.458557
115	0.00000	0.475281	0.475258	0.475267
116	0.00000	0.492194	0.492171	0.492181
117	0.00000	0.509377	0.509354	0.509363
118	0.00000	0.526809	0.526786	0.526796
119	0.00000	0.544460	0.544437	0.544447
120	0.00000	0.562417	0.562394	0.562404
121	0.00000	0.580682	0.580659	0.580669
Final	0.00000	0.599212	0.599189	0.599199

Trees or crops do not grow at all

A second class of errors is that trees or crops do not grow as expected, or other events do not happen as you thought you asked for in the calendar. In such case you can add a new table to the output screen and check where the error originates by tabulating output values related to the event. For trees and crops it is helpful to tabulate the growth stage as well as components of the biomass, to check whether the error is in the plants not getting started at all, or not making biomass. It may be necessary to tabulate input values and compare with the values you intended. Sometimes the x axis for tabulated input parameters, such as the strings of crop or tree parameter, gets changed and all parameter values are shifted by one or

more positions, leading to nonsensical results; if this happens open the graph and read just the number of points. You can try the 'return to default' button on the 'input' screen to restore (unintentional) modifications of parameter settings that may be responsible for unexpected run results; if you want to modify the 'default' values to which you return with this button, you have to modify the values in the dialogue boxes on the 'second level' (the modelling layer).

Appendix 7

Input parameters and their definition

Abbreviations used in parameter names

No	Acronym	Definition	No	Acronym	Definition
1.	AF	"Agroforestry Zone" - overall design of the system	14.	Mn	Nutrients in Litter Layer
2.	C	Crop (C = Crop, C_N = Crop Nutrient or CW = Crop Water)	15.	Mn2	Nutrients in Soil Organic Matter (SOM)
3.	Ca	Crop Calendar (schedule)	16.	N	Nutrient (currently including N and P)
4.	Cent	Input Output Summary for Litter (based on Century Model)	17.	P	Profitability (economic sector of the model)
5.	Cent2	Input Output Summary for SOM (based on Century Model)	18.	PD	Pest and Disease
6.	Cq	Crop Sequence (crop parameters)	19.	Rain	Rain
7.	E	Erosion	20.	Rt	Root
8.	Evap	Evaporation	21.	S&B	Slash and Burn
9.	G	Grazing	22.	S	Soil Structure
10.	LF	Lateral Flow	23.	T	Tree (T=Tree, T_N=Tree Nutrient or TW=Tree Water)
11.	Light	Light	24.	TF	Tree Fruit (oil Palm Module)
12.	Mc	Carbon in Litter Layer	25.	Temp	Temperature
13.	Mc2	Carbon in Soil Organic Matter (SOM)	26.	W	Water

Note: In **plain** style means CORE modules, in **italic** style means ADDITIONAL modules.

No	Acronym	Definition	Dimensions	Range of value (Default value)	Input Section (Link location in Excel)
1.	AF_AnyTrees?	Parameter governing an option to simulate system with trees. Value 0 means system without trees, value 1 means system with trees is possible	dimensionless	0 or 1 (1)	RUN & OUTPUT SECTION
2.	AF_Circ?	Switch to decide on circular versus linear symmetry. 1 = circular system, 0 =linear system	dimensionless	0 or 1 (0)	Agroforestry Zone
3.	AF_Crop?	Parameter governing an option to simulate system with crop. Value 0 means system without crop, value 1 means system with crop	dimensionless	0 or 1 (0)	RUN & OUTPUT SECTION
4.	AF_DeepSubSoil	Equivalent depth of the subsoil below layer 4, that is used to calculate the effective water outflow from the soil column, via S_KsatVDeepSub	m	0 - 10 (3)	Agroforestry Zone
5.	<i>AF_DepthDynamic?</i>	<i>Switch for making the depth of soil layer 1 on sloping land system a dynamic property</i>	<i>dimensionless</i>	<i>0 or 1 (0)</i>	<i>Agroforestry Zone/Sloping Land and Parkland System</i>
6.	AF_DepthGroundWater Table	Depth of groundwater table below the bottom of layer 4, expressed in m. For the time being the value is used as a constant in defining 'field capacity'.	m	0 - 10 (0)	Agroforestry Zone
7.	AF_DepthLay <i>i</i> [Zone]	Soil depth increment in (= layer thickness of) <i>i</i> -th soil layer, <i>i</i> = 1, 2, 3, 4. For sloping land systems the value for the layer 1 is used as average topsoil depth at the start of the run; actual depth of layer 1 will be calculated from the two AF_Slope parameters	m	0 - 1 (.05, .15, .3, .5 for <i>i</i> = 1,...,4)	Agroforestry Zone

No	Acronym	Definition	Dimensions	Range of value (Default value)	Input Section (Link location in Excel)
8.	<i>AF_DynPestImpacts?</i>	<i>Switch governing an option to simulate system with dynamic pest impact. Value 0 means no dynamic pest impacts, value 1 means dynamic pest impacts is possible.</i>	<i>dimensionless</i>	<i>0 - 1 (0)</i>	<i>RUN & OUTPUT SECTION</i>
9.	<i>AF_PlotNumberUphill</i>	<i>Number of similar uphill plot neighbors as source of Lateral Inflow & Run-on</i>	<i>dimensionless</i>	<i>(0)</i>	<i>Agroforestry zone</i>
10.	<i>AF_RunNutLim[SiNut]?</i>	Switch governing an option to simulate system with nutrient limitation. Value 0 means no nutrient limitation, value 1 means nutrient is possible.	dimensionless	0 - 1 (1)	RUN & OUTPUT SECTION
11.	<i>AF_RunOnFrac</i>	<i>Fraction of surface runoff from the area uphill that enters the simulation area as run-on.</i>	<i>dimensionless</i>	<i>0 - 1 (0)</i>	<i>Agroforestry Zone</i>
12.	<i>AF_RunWatLim?</i>	Parameter governing an option to simulate system with water limitation. Value 0 means no water limitation, value 1 means water limitation is possible.	dimensionless	0 - 1 (1)	RUN & OUTPUT SECTION
13.	<i>AF_SimulateWeeds?</i>	<i>Parameter governing an option to simulate weed growth. Value 0 means no weed growth, value 1 means weed will start growing whenever crop is absent.</i>	<i>%</i>	<i>0 or 1 (0)</i>	<i>RUN & OUTPUT SECTION</i>
14.	<i>AF_SlopeInit</i>	<i>Slope (expressed as percent elevation increment per horizontal distance) of the soil surface at the start of the simulation; this value can differ from the slope of the soil profile AF_SlopeSoilHoriz, but should not differ too much.</i>	<i>%</i>	<i>0 - 100 (0)</i>	<i>Agroforestry Zone/Sloping Land and Parkland System</i>

No	Acronym	Definition	Dimensions	Range of value (Default value)	Input Section (Link location in Excel)
15.	<i>AF_SlopeSoilHoriz</i>	<i>Slope (expressed as percent elevation increment per horizontal distance) of the soil horizons below the surface, especially that of the topsoil, used to calculate actual topsoil depth per zone.</i>	%	0 - 100 (0)	<i>Agroforestry Zone/Sloping Land and Parkland System</i>
16.	<i>AF_StoneFrac [Zone, SoilLayer]</i>	<i>Fraction of stone in each soil layer and zone</i>	<i>dimensionless</i>	0 - 1 (0)	<i>Agroforestry Zone</i>
17.	<i>AF_TreePosit[Tree]</i>	Position of each tree type. It can be in zone 1 (1) or zone 4 (4); if one wants it to be in both, two otherwise equal tree types can be defined.	dimensionless	1 or 4 (1)	Agroforestry Zone
18.	<i>AF_Zone[Zone]</i>	Width of each zone. Width of zone 4 is calculated back from <i>AF_ZoneTot</i> minus the sum of zone 1+2+3	m	0 - 100 (.5, 1,1)	Agroforestry Zone
19.	<i>AF_ZoneTot</i>	Total width of agroforestry system simulated	m	0 - 100 (3.5)	Agroforestry Zone
20.	<i>C_AgronYMoistFrac[Cr]</i>	Standard moisture content for expressing marketable yields of each crop	dimensionless	0 - 1 (.15)	(Crop Library)
21.	<i>C_ApplyMaintResp?</i>	<i>On/Off switch for applying the maintenance respiration; 1 = on, 0 = off</i>	<i>dimensionless</i>	<i>0 or 1 (0)</i>	<i>Maintenance Respiration</i>
22.	<i>C_DailyWeedSeedDecay Frac</i>	<i>Fraction of the weed seed bank that loses viability and is transferred to the litter pool for decomposition</i>	<i>fraction day⁻¹</i>	0 - 1 (.02)	<i>Management/ Weed Growth</i>
23.	<i>C_HostEffForT1[Cr]</i>	<i>Effectiveness of crop roots as host for a parasitic tree (T1)</i>	<i>cm³ cm⁻¹</i>	(0)	<i>Root Parasitism</i>
24.	<i>C_RelRespGroRes</i>	<i>Relative weighting factor for growth used in calculating daily maintenance respiration</i>	<i>dimensionless</i>	(.5)	<i>Maintenance Respiration</i>
25.	<i>C_RelRespRt</i>	<i>Relative weighting factor for roots used in calculating daily maintenance respiration</i>	<i>dimensionless</i>	(.3)	<i>Maintenance Respiration</i>

No	Acronym	Definition	Dimensions	Range of value (Default value)	Input Section (Link location in Excel)
26.	<i>C_RelRespStLv</i>	<i>Relative weighting factor for stem & leaves used in calculating daily maintenance respiration</i>	<i>dimensionless</i>	<i>(.5)</i>	<i>Maintenance Respiration</i>
27.	<i>C_RelRespYieldCurr</i>	<i>Relative weighting factor for developing fruits/Yield as part of total biomass as used for maintenance respiration</i>	<i>dimensionless</i>	<i>(1)</i>	<i>Maintenance Respiration</i>
28.	<i>C_ResidRemovalFrac</i>	<i>Fraction of crop residue removed from field (not returned as mulch). The same value applies for all zones and all crops used in the simulation</i>	<i>fraction</i>	<i>0 - 1 (0)</i>	<i>Management/Mulching</i>
29.	<i>C_RespperBiom</i>	<i>The relative use of resources for maintenance respiration per unit biomass</i>	<i>dimensionless</i>	<i>0 - 0.2 (.05)</i>	<i>Maintenance Respiration</i>
30.	<i>C_RespTemp</i>	<i>A graphical relation between temperature and maintenance respiration</i>	<i>dimensionless</i>	<i>(see C_Resp Temp graph)</i>	<i>Maintenance Respiration</i>
31.	<i>C_WeedGermFrac</i>	<i>Fraction of weed seeds in the seed bank that germinates when a new opportunity arises, e.g. at the end of a cropping season</i>	<i>fraction</i>	<i>0 -1 (.1)</i>	<i>Management/Weed Growth</i>
32.	<i>C_WeedSeedBankInit</i>	<i>Initial dry weight of weed seeds in seed bank</i>	<i>kg m⁻²</i>	<i>0 -1 (.01)</i>	<i>Management/Weed Growth</i>
33.	<i>C_WeedSeedExtInflux</i>	<i>Daily influx of weed seeds from outside of the plot</i>	<i>kg m⁻² day⁻¹</i>	<i>0 - 0.1 (.00001)</i>	<i>Management/Weed Growth</i>
34.	<i>Ca_CType[Zone]</i>	<i>A graphical input parameter governing the type of crop planted in sequence, with the possibility of having different crops (and/or planting times) in different zones. Associated with type of crop in database. See WaNuLCAS.xls</i>	<i>dimensionless</i>	<i>1 - 5 (2)</i>	<i>(Crop Management)</i>

No	Acronym	Definition	Dimensions	Range of value (Default value)	Input Section (Link location in Excel)
35.	Ca_DoYStart	Day of year at which simulation starts	julian days	1 - 365 (300)	RUN & OUTPUT SECTION
36.	Ca_ExtOrgApp?[Type]	Parameter governing an option to have simulation with applying external organic input or not. Value 0 means not applying external organic input, value 1 means applying external organic input	dimensionless	0 or 1 (0)	(Crop Management)
37.	Ca_FertApp?[SiNut]	Parameter governing an option to have simulation with applying fertilizer or not. Value 0 means not applying fertilizer, value 1 means applying fertilizer	dimensionless	0 or 1 (1)	(Crop Management)
38.	Ca_FertOrExtOrgApp Amount[Zone]	Amount of N or P fertilizer or external organic applied. A graphical input parameter.	g m^{-2}	0 - 10 (4.5 for each N and P)	(Crop Management)
39.	Ca_FertOrExtOrgAppDoY [SiNut]	Time of fertilizer or external organic input application. A graphical input parameter.	julian days	1 - 365 (see excel sheet Crop Management)	(Crop Management)
40.	Ca_FertOrExtOrgAppYear [SiNut]	Year of fertilizer or external organic input application. A graphical input parameter.	dimensionless	any integer value (see excel sheet Crop Management)	(Crop Management)
41.	Ca_ImmAmount[P,Zone]	Amount of immobile P fertilizer applied. A graphical input parameter	g m^{-2}	(see Ca_ImmAmount graph)	Management/ P Immobile Input
42.	Ca_ImmDOY[P]	Time of immobile P fertilizer application. A graphical input parameter	julian days	1 - 365 (see Ca_ImmDOY graph)	Management/ P Immobile Input

No	Acronym	Definition	Dimensions	Range of value (Default value)	Input Section (Link location in Excel)
43.	Ca_ImmY[P]	Year of immobile P fertilizer application. A graphical input parameter	dimensionless	Any integer value (see Ca_ImmY graph)	Management/ P Immobile Input
44.	Ca_PlantDoY[Zone]	Day of crop planting for each subsequent crop. A graphical input parameter.	julian days	1 - 365 (see excel sheet Crop Management)	(Crop Management)
45.	Ca_PlantYear[Zone]	Year of planting for each subsequent crop. A graphical input parameter	dimensionless	any integer value (see excel sheet Crop Management)	(Crop Management)
46.	Cq_CHarvAlloc[Cr]	Allocation of biomass to harvested parts (grain, tuber) as a function of crop growth stage.	dimensionless	(see Cq_CHarv Alloc table)	(Crop Library)
47.	Cq_ClosedCan[Cr]	Amount of crop canopy biomass at which canopy is closed and nutrient demand per unit new biomass shifts from Cq_ConcYoung to Cq_ConcOld.	kg m ⁻²	0 - 0.5 (0.2)	(Crop Library/ Nutrient Uptake)
48.	Cq_CLWR[Cr]	Crop leaf weight ratio = gram of green leaf area per gram of shoot, for each crop species as a function of crop growth stage.	g m ⁻²	(see Cq_CLWR table)	(Crop Library)
49.	Cq_ConcOld[Cr,SiNut]	Nutrient concentration in crop tissue formed after biomass has reached the Cq_ClosedCan value.	dimensionless	0 - 0.1 (N = .01, P = .0025)	(Crop Library/ Nutrient Uptake)
50.	Cq_ConcRt[Cr]	N concentration in crop roots	dimensionless	0 - 0.1 (.01)	(Crop Library/ Nutrient Uptake)
51.	Cq_ConcYoung[Cr,SiNut]	Nutrient concentration in young crop biomass (before biomass has reached the Cq_ClosedCan value).	dimensionless	0 - 0.1 (N = .015 P = .007)	(Crop Library/ Nutrient Uptake)

No	Acronym	Definition	Dimensions	Range of value (Default value)	Input Section (Link location in Excel)
52.	<i>Cq_CovEff[Cr]</i>	<i>Crop Cover Efficiency factor, used in calculating erosion (Erosion type 1)</i>	<i>dimensionless</i>	0 - 1 (1)	(Crop Library/ Soil Erosion)
53.	Cq_CReLUE[Cr]	Relative light use efficiency (fraction of Cq_GroMax achieved per unit light capture) for each type of crop grown as a function of crop growth stage.	dimensionless	(see Cq_CReLUE table)	(Crop Library)
54.	Cq_DOYFlwBeg[Cr]	The earliest day in a year when crop start to flowers	julian days	1 - 365 (1)	(Crop Library/ Annual or Perennial?)
55.	Cq_DOYFlwEnd[Cr]	The latest day in a year when crop start to flowers	julian days	1 - 365 (365)	(Crop Library/ Annual or Perennial?)
56.	Cq_GroMax[Cr]	Maximum daily dry matter production rate at full light capture, for each crop species under local conditions	kg m ⁻² day ⁻¹	0.001 - 0.1 (.014)	(Crop Library/ Crop Growth)
57.	Cq_Gseed[Cr]	Seed weight (initial C_CarbHydrReserves to be used for growth).	kg m ⁻²	0.001 - 0.1 (.004)	(Crop Library/ Crop Growth)
58.	Cq_HBiomConv[Cr]	Factor for conversion of crop biomass increment (up to crop stage 1) to crop height increment	dimensionless	0.1 - 10 (7)	(Crop Library/ Crop Growth)
59.	Cq_kLight[Cr]	Light extinction coefficient for the crop canopy = efficiency of crop foliage in absorbing light.	dimensionless	0 - 1 (.65)	(Crop Library/ Light Capture)
60.	Cq_LAIMax	Maximum leaf area index for the crop; if more biomass is produced a proportional amount is transferred to the litter layer	dimensionless	(5)	(Crop Library/ Canopy)
61.	Cq_LignResid[Cr]	Lignin concentration of crop residue (eg. 20%=0.2).	dimensionless	0 - 1 (.2)	(Crop Library/ Litter Quality)
62.	Cq_LignRootRes[Cr]	Lignin concentration of crop root residues	dimensionless	0 - 1 (.2)	(Crop Library/ Litter Quality)

No	Acronym	Definition	Dimensions	Range of value (Default value)	Input Section (Link location in Excel)
63.	Cq_Lp[Cr]	Hydraulic conductivity of crop roots, reflecting the physiological entry resistance to water per unit root length and unit gradient.	cm day ⁻¹	0 - 0.00001 (.00001)	(Crop Library/ Water Uptake)
64.	Cq_MaxRemob[Cr]	Maximum proportion of stem and leaves remobilized per day to the CarbHydrReserves pool, from which it can, for example, be used for growth of the storage component (grain, tuber)	day ⁻¹	0 - 0.1 (.05)	(Crop Library/ Crop Growth)
65.	Cq_MycMaxInf[Cr]	<i>Fraction of crop roots infected by mycorrhiza for a soil layer where the Rt_MTInfFrac parameter is 1</i>	<i>dimensionless</i>	<i>0 - 1 (.25)</i>	<i>(Crop Library/ Mycorrhiza Fraction)</i>
66.	Cq_NFixDayFrac[Cr]	Fraction of current N deficit derived from atmospheric N ₂ fixation per day for each crop type, if Cq_NFixVariable = 0 ('false').	day ⁻¹	0 - 1 (0)	(Crop Library/ N Fixation)
67.	Cq_NFixDWMaxFrac[Cr]	Maximum fraction of the C_GroRes[Dw] pool that can be respired for N ₂ fixation if Cq_NFixVariable = 0 ('false')	day ⁻¹	0 - 0.5 (.1)	(Crop Library/ N Fixation)
68.	Cq_NFixDWUnitCost[Cr]	Dry weight cost for respiration per unit N ₂ fixation, if Cq_NFixVariable = 0 ('false')	kg [dw] g ⁻¹ [N]	0 - 1 (.01)	(Crop Library/ N Fixation)
69.	Cq_NFixResp[Cr]	Responsiveness of N ₂ fixation to N stress (N in biomass divided by N target), if Cq_NFixVariable = 0 ('false')	dimensionless	0 - 5 (1)	(Crop Library/ N Fixation)
70.	Cq_NFixVariable?[Cr]	Switch (0 = false, 1 = true) to choose between variable (N-stress dependent) versus constant N ₂ fixation as fraction of N deficit	dimensionless	0 or 1 (0)	(Crop Library/ N Fixation)
71.	Cq_NutMobC[Cr,SiNut]	<i>Relative rate of transfer, per unit root length density (cm cm⁻³), from the 'immobile' pool of nutrients to the 'mobile' or sorbed pool, due to Crop root activity</i>	<i>m² day⁻¹</i>	<i>0 - 0.02 (0)</i>	<i>Crop Library/ Crop effect on nutrient mobility</i>

No	Acronym	Definition	Dimensions	Range of value (Default value)	Input Section (Link location in Excel)
72.	Cq_PotSuctAlphMax[Cr]	Plant potential where transpiration is $(1 - \text{Alpha}) \times \text{potential transpiration}$, Alpha is a small value (e.g. 0.01). Value could be different depend on crop type.	cm	-6000 - -4000 (-5000)	(Crop Library/ Water Uptake)
73.	Cq_PotSuctAlphMin[Cr]	Plant potential where transpiration is $\text{Alpha} \times \text{potential transpiration}$, Alpha is a small value (e.g. 0.01). Value could be different depend on crop type.	cm	-16000 - -14000 (-15000)	(Crop Library/ Water Uptake)
74.	Cq_RainWStorCap[Cr]	Rainfall water stored as thin film at leaf surface	mm	0 - 2 (1)	(Crop Library/ Rain Interception)
75.	Cq_RelLightMaxGr[Cr]	Relative light intensity at which shading starts to affect tree growth	dimensionless	0 - 1 (1)	(Crop Library/ Light Capture)
76.	Cq_RhizEffKaPC[Cr]	Proportional reduction of the apparent adsorption constant for P due to root activity of the crop, expressed as fraction of N_{KaPdef} per unit crop root length density	$\text{m}^2 \text{ day}^{-1}$	0 - 0.2 (0)	(Crop Library/ Crop effect on nutrient mobility)
77.	Cq_RtAlloc[Cr]	Fraction of crop growth reserves allocated to root biomass in the absence of water or nutrient stress as a function of crop stage (only for $Rt_ACType=2$).	day^{-1}	(see Cq_RtAlloc table)	(Crop Library)
78.	Cq_RtAllocResp[Cr]	Crop root allocation responsiveness to water or nutrient (the factor currently in minimum supply) stress; 0 = constant root allocation, 1 = linear response to water and nitrogen stress, >1 more-than-proportional response (only for $Rt_ACType = 2$)	dimensionless	0 - 2 (2)	(Crop Library/Roots)
79.	Cq_RtDiam[Cr]	Crop root diameter. It is used in calculating water and nutrient uptake.	cm	0.05 - 1 (.02)	(Crop Library/Roots)

No	Acronym	Definition	Dimensions	Range of value (Default value)	Input Section (Link location in Excel)
80.	Cq_SingleCycle?[Cr]	A parameter deciding what happens after fruits are ripe: 1 = annual that dies back, 0 = perennial that returns to crop stage =1.	dimensionless	0 or 1 (1)	(Crop Library/ Annual or Perennial?)
81.	Cq_SLA[Cr]	Crop specific leaf area = green surface area (one-sided) per unit leaf dry weight, for each crop species as a function of crop growth stage. For Cq_Atype =1, ..., 5, default values are provided. Cq_AType = 6, ..,10 user defined, as before.	m ² g ⁻¹	(see Cq_SLA table)	(Crop Library)
82.	Cq_TimeGen[Cr]	Length of generative stage for each crop. For Cq_Atype =1, ..., 5, default values are provided, but can be modified to adopt the default crop parameters to local conditions.	days	0 - 1000 (30)	(Crop Library/ Crop Stage)
83.	Cq_TimeVeg[Cr]	Length of vegetative stage for each crop. For Cq_Atype =1, ..., 5, default values are provided, but can be modified to adopt the default crop parameters to local conditions.	days	0 - 1000 (60)	(Crop Library/ Crop Stage)
84.	Cq_TranspRatio[Cr]	Amount of water needed per unit dry matter production of each crop species. For Cq_Atype =1, ..., 5, default values are provided. For Cq_AType=6, ..., 10 user defined	l kg ⁻¹	200 - 600 (300)	(Crop Library/ Crop Growth)
85.	Cq_WeedType	<i>Weed type. This is user defined. Weed biomass growth follows the rules of crop growth. It takes the same type of parameters as crop. All the related input parameters are in Excel sheet</i>	<i>dimensionless</i>	<i>(5)</i>	<i>Management/ Weed Growth</i>
86.	E_BulkDens	Bulk density used in converting soil mass movement to changes in volume of topsoil per zone	g cm ⁻³	0.5 - 1.6 (1.4)	(Soil Hydraulic)
87.	E_CovEffT[Tree]	<i>Tree cover efficiency factor (per unit tree LAI)</i>	<i>dimensionless</i>	<i>0 - 1 (.5)</i>	<i>(Tree Library/ Erosion Protection)</i>

No	Acronym	Definition	Dimensions	Range of value (Default value)	Input Section (Link location in Excel)
88.	<i>E_EntrainmentCoeffBare Plot</i>	<i>Entrainment coefficient for sediment movement (Rose equation) in the absence of vegetative soil cover</i>	<i>kg⁻¹ (soil) mm⁻¹ m²</i>	<i>0 - 1 (.002)</i>	<i>Soil Erosion and Sedimentation</i>
89.	<i>E_ErosiType</i>	<i>Parameter to decide on model of erosion used. 1 = using USLE, 0 = using Rose Equation</i>	<i>dimensionless</i>	<i>0 or 1 (0)</i>	<i>Soil Erosion and Sedimentation</i>
90.	<i>E_IntvPloughPlant</i>	<i>Length of ploughing time</i>	<i>julian days</i>	<i>1 - 365 (10)</i>	<i>Management/Tillage</i>
91.	<i>E_PloughBefPlant?</i>	<i>Paramater governing option to plough before planting (0 = no ploughing, 1 = ploughing before planting)</i>	<i>dimensionless</i>	<i>0 or 1 (0)</i>	<i>Management/Tillage</i>
92.	<i>E_PloughDoY</i>	<i>Date of ploughing</i>	<i>julian days</i>	<i>1 - 365 (364)</i>	<i>Management/Tillage</i>
93.	<i>E_PloughY</i>	<i>Year of ploughing</i>	<i>dimensionless</i>	<i>0 - 100 (100)</i>	<i>Management/Tillage</i>
94.	<i>E_RainFac</i>	<i>A multiplier determining impact of rainfall on soil erosion, for calculation soil loss using USLE</i>	<i>dimensionless</i>	<i>0 - 10 (1)</i>	<i>Soil Erosion and Sedimentation</i>
95.	<i>E_SoilMoveperPlough</i>	<i>Amount of soil moved per ploughing event, for calculation soil loss using USLE</i>	<i>kg m⁻²</i>	<i>0 - 500 (399)</i>	<i>Soil Erosion and Sedimentation</i>
96.	<i>E_SoilType</i>	<i>Type of soil. 1 = medium, 2 = sandy, 3 = clay</i>	<i>dimensionless</i>	<i>1, 2, 3 (1)</i>	<i>Soil Erosion and Sedimentation</i>
97.	<i>E_TillZone?[Zone]</i>	<i>On/off switch for tilling activity in each zone (0 = no tillage, 1 = with tillage)</i>	<i>dimensionless</i>	<i>0 or 1 (0, 1, 1, 1)</i>	<i>Management/Tillage</i>
98.	<i>Evap_MulchEffSurfLit</i>	<i>Effect of mulch on the amount of water evaporating from the soil</i>	<i>dimensionless</i>	<i>(1)</i>	<i>Soil Evaporation</i>
99.	<i>GHG_LitMinMultiplier</i>	<i>Multiplier of litter mineralization for quick modifications of nitrogen oxide emission</i>	<i>dimensionless</i>	<i>(1)</i>	<i>Soil Water & Nutrient/ Nox emissions</i>

No	Acronym	Definition	Dimensions	Range of value (Default value)	Input Section (Link location in Excel)
100.	GHG_N2perNOx	Ratio of nitrous and nitric oxide	dimensionless	See graph GHG_N2perNOx	Soil Water & Nutrient/ Nox emissions
101.	LF_FracGWReleaseAsInflow	The fraction of groundwater that flow out that reaches the simulated zone (this depends on subsoil stratification and landscape characteristics beyond the scope of out current model)	dimensionless	(0)	Agroforestry Zone
102.	LF_GWReleaseFraction	The fraction of the current stock of groundwater that flows out on a daily basis. A stock of groundwater stored uphill depends on the 'number of plots uphill'.	dimensionless	(.05)	Agroforestry Zone
103.	LF_SubSurfInflow4	Amount of sub surface water inflow in layer 4	mm day ¹	0 - 5 (0)	Agroforestry zone
104.	Mc_Carbon	Proportion of total carbon in plant litter and residue	dimensionless	0 - 0.5 (.42)	Soil Organic Matter and Litter Quality/ Litter Quality
105.	Mc_CExtOrg[type]	Carbon concentration of external input	dimensionless	0 - 1 (.4)	Litter Quality/ Quality of Ext. Organic Input
106.	Mc_CNAtInitMetab[zone]	Initial C:N ratio metabolic pool of litter	dimensionless	(8)	Soil Organic Matter and Litter Quality/ Initial C & N in Litter Pool
107.	Mc_KAct	Decay rate for decomposition of active pool of soil organic matter	dimensionless	(.02)	Soil Organic Matter and Litter Quality/ Other Factors Affecting Decomposition

No	Acronym	Definition	Dimensions	Range of value (Default value)	Input Section (Link location in Excel)
108.	Mc_KMetab	Decay rate for decomposition of active pool of soil organic matter	dimensionless	(.05)	Soil Organic Matter and Litter Quality/ Other Factors Affecting Decomposition
109.	Mc_KPass	Decay rate for decomposition of active pool of soil organic matter	dimensionless	(.0000186)	Soil Organic Matter and Litter Quality/ Other Factors Affecting Decomposition
110.	Mc_KSIw	Decay rate for decomposition of active pool of soil organic matter	dimensionless	(.000543)	Soil Organic Matter and Litter Quality/ Other Factors Affecting Decomposition
111.	Mc_KStruc	Decay rate for decomposition of active pool of soil organic matter	dimensionless	(.013429)	Soil Organic Matter and Litter Quality/ Other Factors affecting Decomposition
112.	Mc_LignExtOrg[Type]	Lignin concentration of external input.	dimensionless	0 - 1 (.2)	Soil Organic Matter and Litter Quality/ Quality of Ext. Organic Input
113.	Mc_PolypExtOrg[Type]	Polyphenol concentration of external input	dimensionless	0 - 1 (0)	Soil Organic Matter and Litter Quality/ Quality of Ext. Organic Input

No	Acronym	Definition	Dimensions	Range of value (Default value)	Input Section (Link location in Excel)
114.	Mc2_Clay	Proportion of clay in soil (only for soil organic matter type 2)	dimensionless	0 - 1 (.316)	Soil Organic Matter and Litter Quality/ Other Factors Affecting Decomposition
115.	Mc2_ClayCoeffCref	Coefficient of clay based on tabulated Cref for soil organic matter type 2	dimensionless	(.94)	Soil Organic Matter and Litter Quality/ Other Factors Affecting Decomposition
116.	Mc2_CNRateInitMetab [zone]	Initial C:N ratio metabolic pool of soil organic matter	dimensionless	(8)	Soil Organic Matter and Litter Quality/ Initial C & N in SOM Pool
117.	Mc2_CorgInitMeth3	Initial soil organic carbon value in soil organic matter pool using Type 3.	gr cm ⁻²	(2)	Soil Organic Matter and Litter Quality/ Initial C & N in SOM Pool
118.	Mc2_CorgpCref	Initial soil organic carbon value in soil organic matter pool using Type 3.	gr cm ⁻²	(.8)	Soil Organic Matter and Litter Quality/ Initial C & N in SOM Pool
119.	Mc2_CrefMeth3	Initial C-ref value in soil organic matter pool using Type 2.	gr cm ⁻²	(3)	Soil Organic Matter and Litter Quality/ Initial C & N in SOM Pool
120.	Mc2_CrefOffset	Constant for C reference tabulated for soil organic matter type 2.	dimensionless	(1.256)	Soil Organic Matter and Litter Quality/ Other Factors Affecting Decomposition

No	Acronym	Definition	Dimensions	Range of value (Default value)	Input Section (Link location in Excel)
121.	Mc2_pH	Soil pH (only for soil organic matter type 2)	dimensionless	(5)	Soil Organic Matter and Litter quality/ Other Factors Affecting Decomposition
122.	Mc2_pHCoeffCref	Coefficient of pH based on tabulated of Cref for soil organic matter type 2	dimensionless	(-.156)	Soil Organic Matter and Litter Quality/ Other Factors Affecting Decomposition
123.	Mc2_RainTransfer[Pool]	Rain factor which control transferring process of litter to SOM pool	dimensionless	(.001)	Soil Organic Matter and Litter Quality Litter → SOM Transfer
124.	Mc2_Silt	Proportion of silt in soil (only for soil organic matter type 2)	dimensionless	0 - 1 (.2)	Soil Organic Matter and Litter Quality/ Other Factors Affecting Decomposition
125.	Mc2_SiltClayCoeffCref	Coefficient of clay and silt based on tabulated Cref for soil organic matter type 2	dimensionless	(.703219)	Soil Organic Matter and Litter Quality/ Other Factors Affecting Decomposition
126.	Mc2_SoilTillTransfer [Pool]	Soil tillage factor which control transferring process of litter to SOM pool	dimensionless	(1)	Soil Organic Matter and Litter Quality/ Litter → SOM Transfer
127.	Mc2_SOMDistribution [SoilLayer]	Relative distribution of carbon between different soil layers	fraction	0 - 1 (1, .2, .1, .05)	Soil Organic Matter and Litter Quality/ SOM Distribution

No	Acronym	Definition	Dimensions	Range of value (Default value)	Input Section (Link location in Excel)
128.	Mc2_SOMInitType	Parameter defining methods to initialize soil organic matter pool. Three methods are provided for initializing the soil organic matter pools: Type = 1 the user can specify all pool sizes for all zones, Type = 2 the user can specify the size of all pools relative to those for a forest soil (Cref) that is calculated from soil texture data, Type = 3 the user specifies the Corg and Cref directly, but otherwise follows the procedure of Type 2	dimensionless	1, 2, 3 (1)	Soil Organic Matter and Litter Quality/ Initial C & N in SOM Pool
129.	Mc2_WormTransfer [Pool]	Worm factor which control transferring process of litter to SOM pool	dimensionless	0.003 - 0.1 (Struc, Metab and Act = .1; Slow = .3; Pass = .003)	Soil Organic Matter and Litter Quality/ Litter → SOM Transfer
130.	Mn_CNAct	C:N ratio of active pools	dimensionless	5 - 10 (8)	Soil Organic Matter and Litter Quality/ C:N Ratio of Litter Pool
131.	Mn_CNPass	C:N ratio of passive pools	dimensionless	8 - 15 (11)	Soil Organic Matter and Litter Quality/ C:N Ratio of Litter Pool
132.	Mn_InitAct[Zone]	Initial amount of N in active Litter pool of each zone	mg cm ⁻³	0 - 1 (.00002)	Soil Organic Matter and Litter Quality/ Initial C & N in Litter Pool
133.	Mn_InitMetab[Zone]	Initial amount of N in metabolic Litter pool of each zone	mg cm ⁻³	0 - 1 (0)	Soil Organic Matter and Litter Quality/ Initial C & N in Litter Pool

No	Acronym	Definition	Dimensions	Range of value (Default value)	Input Section (Link location in Excel)
134.	Mn_InitPass[Zone]	Initial amount of N in passive Litter pool of each zone	mg cm ⁻³	0 - 1 (.0001)	Soil Organic Matter and Litter Quality/ Initial C & N in Litter Pool
135.	Mn_InitSlw[Zone]	Initial amount of N in slow Litter pool of each zone	mg cm ⁻³	0 - 1 (.000001)	Soil Organic Matter and Litter Quality/ Initial C & N in Litter Pool
136.	Mn_InitStruc[Zone]	Initial amount of N in structural Litter pool of each zone	mg cm ⁻³	0 - 1 (0)	Soil Organic Matter and Litter Quality/ Initial C & N in Litter Pool
137.	Mn_NutRatAct[P]	Ratio of N to P (N:P) in active organic matter pools	dimensionless	1 - 10 (10)	Soil Organic Matter and Litter Quality/ C:N Ratio of Litter Pool
138.	Mn_NutRatMetab[P]	Ratio of N to P (N:P) in metabolic organic matter pools	dimensionless	1 - 10 (10)	Soil Organic Matter and Litter Quality/ C:N Ratio of Litter Pool
139.	Mn_InitSlw[Zone]	Initial amount of N in slow Litter pool of each zone	mg cm ⁻³	0 - 1 (.000001)	Soil Organic Matter and Litter Quality/ Initial C & N in Litter Pool
140.	Mn_InitStruc[Zone]	Initial amount of N in structural Litter pool of each zone	mg cm ⁻³	0 - 1 (0)	Soil Organic Matter and Litter Quality/ Initial C & N in Litter Pool

No	Acronym	Definition	Dimensions	Range of value (Default value)	Input Section (Link location in Excel)
141.	Mn_LatFlowFertKm	Runoff flow that causes half of the (undissolved) surface fertilizer to move to the next zone	mm	(10)	Soil Water & Nutrient/ Fertilizer Movement
142.	Mn_NutRatAct[P]	Ratio of N to P (N:P) in active organic matter pools	dimensionless	1 - 10 (10)	Soil Organic Matter and Litter Quality/ C:N Ratio of Litter Pool
143.	Mn_NutRatMetab[P]	Ratio of N to P (N:P) in metabolic organic matter pools	dimensionless	1 - 10 (10)	Soil Organic Matter and Litter Quality/ C:N Ratio of Litter Pool
144.	Mn_NutRatPass[P]	Ratio of N to P (N:P) in passive organic matter pools	dimensionless	1 - 10 (10)	Soil Organic Matter and Litter Quality/ C:N Ratio of Litter Pool
145.	Mn_NutRatSlw[P]	Ratio of N to P (N:P) in slow organic matter pools	dimensionless	1 - 10 (10)	Soil Organic Matter and Litter Quality/ C:N Ratio of Litter Pool
146.	Mn_NutRatStruc[P]	Ratio of N to P (N:P) in structural organic matter pools	dimensionless	1 - 10 (10)	Soil Organic Matter and Litter Quality/ C:N Ratio of Litter Pool
147.	Mn2_InitAct[Zone]	Initial amount of N in active SOM pool of each zone	mg cm ⁻³	0 - 1 (.2)	Soil Organic Matter and Litter Quality/ Initial C & N in SOM Pool

No	Acronym	Definition	Dimensions	Range of value (Default value)	Input Section (Link location in Excel)
148.	Mn2_InitMetab[Zone]	Initial amount of N in metabolic SOM pool of each zone	mg cm ⁻³	0 - 1 (0)	Soil Organic Matter and Litter Quality/ Initial C & N in SOM Pool
149.	Mn2_InitPass[Zone]	Initial amount of N in passive SOM pool of each zone	mg cm ⁻³	0 - 1 (3.9)	Soil Organic Matter and Litter Quality/ Initial C & N in SOM Pool
150.	Mn2_InitSlw[Zone]	Initial amount of N in slow SOM pool of each zone	mg cm ⁻³	0 - 1 (1)	Soil Organic Matter and Litter Quality/ Initial C & N in SOM Pool
151.	Mn2_InitStruc[Zone]	Initial amount of N in structural SOM pool of each zone	mg cm ⁻³	0 - 1 (0)	Soil Organic Matter and Litter Quality/ Initial C & N in SOM Pool
152.	<i>N15_Addi [Zone]</i>	<i>Initial amount of N15 in soil layer i of each zone</i>	<i>mg cm⁻³</i>	<i>(0)</i>	<i>N¹⁵ model sector</i>
153.	<i>N_BypassMacro[iZone]</i>	<i>Prefential flows of nutrients in the leachate relative to average concentration * water flow; values < 1 indicates retardation of nutrients due to bypass flow of water in macropores at soil layer i</i>	<i>dimensionless</i>	<i>0 - 2 (1)</i>	<i>Soil Water and Nutrient/ Macropore Bypass Flow</i>
154.	<i>N_DiffCoef[SiNut]</i>	<i>Nitrogen diffusion coefficient</i>	<i>cm² day⁻¹</i>	<i>0 - 1 (N = 1, P = .76896)</i>	<i>Soil Water and Nutrient/ Diffusivity coefficient</i>
155.	N_FracNO3 _i [Zone]	Fraction of NO ₃ of total N in <i>i</i> -th soil layer	dimensionless	0 - 1 (0.4)	Soil Water and Nutrient/Nitrate Fraction

No	Acronym	Definition	Dimensions	Range of value (Default value)	Input Section (Link location in Excel)
156.	<i>N_Imlnit</i> [Zone,SiNut]	<i>Initial amount of nutrient in immobile pool of each zone</i>	<i>mg cm⁻³</i>	<i>0 - 0.1 (N = .05, P = .01)</i>	<i>Soil Water and Nutrient/Initial Immobile Nutrient</i>
157.	<i>N_Ninit</i> [Zone,SiNut]	Initial amount of nutrient in soil layer <i>i</i> of each zone. N layer 1 = .003, layer 2 - 4 = .01 ; P layer 1 = .1, layer 2 = .08, layer 3 - 4 = .04	mg cm ⁻³	0 - 0.5 (see definition)	For N in Soil Water and Nutrient/Initial Soil Nutrient, For P in (Phosphorus/Initial P availability Index per Zone and Layer)
158.	<i>N_KaNH4</i> [Zone]	Apparent (instantaneous) adsorption constant or ratio of amount NH ₄ adsorbed and amount in solution for <i>i</i> -th layer	mg cm ⁻³	0 - 1 (5)	Soil Water and Nutrient/Adsorption constant for N
159.	<i>N_KaNO3</i> [Zone]	Apparent (instantaneous) adsorption constant or ratio of amount NO ₃ adsorbed and amount in solution for <i>i</i> -th layer	mg cm ⁻³	0 - 1 (.3)	Soil Water and Nutrient/Adsorption constant for N
160.	<i>N_KaPDef</i> [Zone]	Apparent (instantaneous) adsorption constant for inorganic P, or ratio of amount of inorganic P adsorbed and the amount in soil solution; the adsorption constant depends on the P concentration on soil solution and is read in a tabular form (as graphical input parameter).	mg cm ⁻³	(see <i>N_KaPDef</i> table)	(Phosphorus/ to P sorption data)
161.	<i>N_Lat4InflowRelConc</i>	<i>Nutrient concentrations in the incoming sub-surface flows into zone 4, relative to the current average nutrient concentration in that layer across all zones in the simulated area</i>	<i>dimensionless</i>	<i>0 - 10 (1)</i>	<i>Agroforestry Zone</i>
162.	<i>N_NutMobi</i> [SiNut]	<i>Relative rate of transfer from the 'immobile' pool of nutrients to the 'mobile' or sorbed pool, due to processes other than root activity in soil layer i</i>	<i>day⁻¹</i>	<i>0 - 0.02 (0)</i>	<i>Soil Nutrient/ Nutrient Mobilization</i>

No	Acronym	Definition	Dimensions	Range of value (Default value)	Input Section (Link location in Excel)
163.	<i>N_RtSynLoc</i>	<i>Root synlocation, or degree to which roots of the crop and tree are co-occurring within the various soil layers, affecting the way in which benefits of rhizosphere modification are shared: 1 = sharing of rhizosphere modifications by all roots present, based on their share in total root length, 0 = complete monopoly by roots modifying the rhizosphere</i>	<i>dimensionless</i>	<i>0 – 1 (.5)</i>	<i>Roots and Mycorrhiza</i>
164.	<i>N_UseNGassLossEst?</i>	<i>A switch determining simulate system with gaseous N losses. 0 = no gaseous N losses, 1 = with gaseous N losses</i>	<i>dimensionless</i>	<i>(0)</i>	<i>Soil Water & Nutrient</i>
165.	<i>P_BurnLab</i>	<i>Amount of labour involved in burning the field per unit simulated filed</i>	<i>person days ha⁻¹</i>	<i>(see excel sheet Profitability)</i>	<i>(Profitability)</i>
166.	<i>P_CfertPrice[SiNut,Price]</i>	<i>Cost of fertilizer at social and private prices, respectively.</i>	<i>currency unit kg⁻¹</i>	<i>(see excel sheet Profitability)</i>	<i>(Profitability)</i>
167.	<i>P_CHarvLab[Cr]</i>	<i>Amount of labour involved in harvesting crop products per unit dry weight</i>	<i>person days Mg⁻¹ per cropping season</i>	<i>(see excel sheet Crop Library/ Crop Library)</i>	<i>(Crop Library/ Profitability)</i>
168.	<i>P_CPestContLab[Cr]</i>	<i>Amount of labour involved in pest control per cropping season</i>	<i>person days ha⁻¹ per cropping season</i>	<i>(see excel sheet Crop Library/ Crop Library)</i>	<i>(Crop Library/ Profitability)</i>
169.	<i>P_CpestContPrice[Price]</i>	<i>Amount of direct costs (outside labour) involved in pest control per cropping season</i>	<i>currency unit per ha⁻¹ per cropping season</i>	<i>(see excel sheet Profitability)</i>	<i>(Profitability)</i>
170.	<i>P_CPlantLab[Cr]</i>	<i>Amount of labour involved in planting per cropping season</i>	<i>person days ha⁻¹ per cropping season</i>	<i>(see excel sheet Crop Library/ Crop Library)</i>	<i>(Crop Library/ Profitability)</i>
171.	<i>P_CropProfThreshold</i>	<i>Threshold value for crop profitability. Relevant to parameter P_UseCropStopRule? = 1</i>	<i>Currency unit</i>	<i>(100000)</i>	<i>Management/ Ending a Crop Cycle</i>

No	Acronym	Definition	Dimensions	Range of value (Default value)	Input Section (Link location in Excel)
172.	<i>P_CSeedPrice[Cr,Price]</i>	<i>Cost of crop seed per kg at social and private prices, respectively.</i>	<i>currency unit kg⁻¹</i>	<i>(see excel sheet Crop Library)</i>	<i>(Crop Library/ Profitability)</i>
173.	<i>P_CWeedLab[Cr]</i>	<i>Amount of labour involved in weeding per cropping season</i>	<i>person days ha⁻¹ per cropping season</i>	<i>(see excel sheet Crop Library)</i>	<i>(Crop Library/ Profitability)</i>
174.	<i>P_CyieldPrice[Cr, Price]</i>	<i>Price of crop yield per unit dry weight at social and private prices, respectively.</i>	<i>currency unit kg⁻¹</i>	<i>(see excel sheet Crop Library)</i>	<i>(Crop Library/ Profitability)</i>
175.	<i>P_DiscountRate</i>	<i>Discount rate (% per year) that applies to both social and private prices</i>	<i>% year⁻¹</i>	<i>(see excel sheet Profitability)</i>	<i>(Profitability)</i>
176.	<i>P_ExtOrgPrice [Type,Price]</i>	<i>Price of external organic input</i>	<i>currency unit kg⁻¹</i>	<i>(see excel sheet Profitability)</i>	<i>(Profitability)</i>
177.	<i>P_FenceMatCost [Price]</i>	<i>Price of off-farm material used for building or maintaining a fence around the field</i>	<i>currency unit ha⁻¹</i>	<i>(see excel sheet Profitability)</i>	<i>(Profitability)</i>
178.	<i>P_TFruitHarvLab</i>	<i>Amount of labour involved in harvesting fruits per unit dry weight</i>	<i>person days kg⁻¹</i>	<i>(see excel sheet Tree Library)</i>	<i>(Tree Library/ Profitability)</i>
179.	<i>P_TFruitPrice[Price]</i>	<i>Price of tree fruit yield per unit dry weight at social and private prices, respectively.</i>	<i>currency unit kg⁻¹</i>	<i>(see excel sheet Tree Library)</i>	<i>(Tree Library/ Profitability)</i>
180.	<i>P_TLatexHarvLab</i>	<i>Amount of labour involved in harvesting latex per unit dry weight</i>	<i>person days kg⁻¹</i>	<i>(see excel sheet Tree Library)</i>	<i>(Tree Library/ Profitability)</i>
181.	<i>P_TLatexPrice[Price]</i>	<i>Price of tree latex yield per unit dry weight at social and private prices, respectively.</i>	<i>currency unit kg⁻¹</i>	<i>(see excel sheet Tree Library)</i>	<i>(Tree Library/ Profitability)</i>
182.	<i>P_TPlantLab</i>	<i>Amount of labour involved in planting trees per unit dry weight</i>	<i>person days kg⁻¹</i>	<i>(see excel sheet Tree Library)</i>	<i>(Tree Library/ Profitability)</i>
183.	<i>P_TPrunLab[Tree]</i>	<i>Amount of labour involved in pruning trees per unit dry weight</i>	<i>person days kg⁻¹</i>	<i>(see excel sheet Tree Library)</i>	<i>(Tree Library/ Profitability)</i>

No	Acronym	Definition	Dimensions	Range of value (Default value)	Input Section (Link location in Excel)
184.	<i>P_TPrunPrice[Price]</i>	<i>Price of tree prunings harvested from the field per unit dry weight at social and private prices, respectively.</i>	<i>currency unit kg⁻¹</i>	<i>(see excel sheet Tree Library)</i>	<i>(Tree Library/ Profitability)</i>
185.	<i>P_TSeedPrice[Price]</i>	<i>Costs of tree planting material per unit initial tree biomass at social and private prices, respectively.</i>	<i>currency unit tree⁻¹</i>	<i>(see excel sheet Tree Library)</i>	<i>(Tree Library/ Profitability)</i>
186.	<i>P_TWWoodHarvLab</i>	<i>Amount of labour involved in harvesting wood products per unit dry weight</i>	<i>person days kg=1</i>	<i>(see excel sheet Tree Library)</i>	<i>(Tree Library/ Profitability)</i>
187.	<i>P_TWWoodPrice[Price]</i>	<i>Price of tree wood product yield per unit dry weight at social and private prices, respectively.</i>	<i>currency unit kg⁻¹</i>	<i>(see excel sheet Tree Library)</i>	<i>(Tree Library/ Profitability)</i>
188.	<i>P_UnitLabCost[Price]</i>	<i>Cost per unit labour at social and private prices, respectively</i>	<i>currency unit person days⁻¹</i>	<i>(see excel sheet Profitability)</i>	<i>(Profitability)</i>
189.	<i>PD_CeatenBy[Cr,Animals]</i>	<i>Fraction of crop component lost if eaten by animals. Default animals are pigs, monkey, locust, nematode, goat, buffalo and birds</i>	<i>dimensionless</i>	<i>0 - 1 (0)</i>	<i>(Crop Library/ Sensitivity to Pest Damage)</i>
190.	<i>P_UseCropStopRule?</i>	<i>A switch determining the simulation will continue to growth crop or not when the previous crop profitability lower than the threshold value. 0 means continue to growth crop, 1 = stop to growth crop</i>	<i>dimensionless</i>	<i>(0)</i>	<i>Management/ Ending a Crop Cycle</i>
191.	<i>PD_CFrugivore? [Animals]</i>	<i>A switch determining the presence of attack by each default animal. 0 = animals is not a crop frugivore, 1 = animal is frugivore</i>	<i>dimensionless</i>	<i>0 or 1 (0)</i>	<i>Pest and Disease</i>
192.	<i>PD_CFrugivory[Cr]</i>	<i>Constant daily fraction of crop fruit biomass removed due to the action of frugivores</i>	<i>dimensionless</i>	<i>0 - 1 (0)</i>	<i>Pest and Diseases</i>
193.	<i>PD_CHerbivore? [Animals]</i>	<i>A switch determining the presence of attack by each default animal. 0 = animals is not a crop herbivore, 1 = animal is herbivore</i>	<i>dimensionless</i>	<i>0 or 1 (0)</i>	<i>Pest and Disease</i>

No	Acronym	Definition	Dimensions	Range of value (Default value)	Input Section (Link location in Excel)
194.	<i>PD_CHerbivore?</i> <i>[Animals]</i>	<i>A switch determining the presence of attack by each default animal. 0 = animals is not a crop herbivore, 1 = animal is herbivore</i>	<i>dimensionless</i>	<i>0 or 1 (0)</i>	<i>Pest and Disease</i>
195.	<i>PD_CHerbivory[Cr]</i>	<i>Constant daily fraction of crop leaf biomass removed due to the action of herbivores</i>	<i>dimensionless</i>	<i>0 - 1 (0)</i>	<i>Pest and Diseases</i>
196.	<i>PD_CRhizovore?</i> <i>[Animals]</i>	<i>A switch determining the presence of attack by each default animal. 0 = animals is not a crop rhizovore, 1 = animal is rhizovore</i>	<i>dimensionless</i>	<i>0 or 1 (0)</i>	<i>Pest and Disease</i>
197.	<i>PD_CRhizovory[Cr]</i>	<i>Constant daily fraction of crop root biomass removed due to the action of rhizovores</i>	<i>dimensionless</i>	<i>0 - 1 (0)</i>	<i>Pest and Diseases</i>
198.	<i>PD_FenceBuildDOY</i>	<i>Schedule for day of fencing for each fencing event. A graphical input.</i>	<i>julian days</i>	<i>(see PD_FenceBuild DOY graph)</i>	<i>Pest and Disease</i>
199.	<i>PD_FenceBuildLab</i>	<i>Amount of labour needed to build fence for each fencing event. A graphical input.</i>	<i>person days</i>	<i>(see PD_FenceBuild Lab graph)</i>	<i>Pest and Disease</i>
200.	<i>PD_FenceBuildY</i>	<i>Schedule for year of fencing for each fencing event A graphical input.</i>	<i>dimensionless</i>	<i>(see PD_FenceBuildY graph)</i>	<i>Pest and Disease</i>
201.	<i>PD_FenceDeck</i>	<i>Daily fractional decay of fence quality</i>	<i>day⁻¹</i>	<i>0 - 1 (.02)</i>	<i>Pest and Diseases</i>
202.	<i>PD_FenceFullQua</i>	<i>Maximum quality of fence</i>	<i>dimensionless</i>	<i>1 - 4 (2)</i>	<i>Pest and Diseases</i>
203.	<i>PD_FenceMaint?</i>	<i>Switch determining fence maintenance. 1 = fence maintenance will be done automatically, 0 = no fence maintenance</i>	<i>dimensionless</i>	<i>0 or 1 (0)</i>	<i>Pest and Disease</i>
204.	<i>PD_FenceMUnit</i>	<i>Unit improvement of fence quality once it falls below the threshold set in PD_FenceQThresh</i>	<i>dimensionless</i>	<i>0 - 2 (.25)</i>	<i>Pest and Disease</i>

No	Acronym	Definition	Dimensions	Range of value (Default value)	Input Section (Link location in Excel)
205.	<i>PD_FenceQThresh</i>	<i>Threshold of (relative) fence quality below which labour will be used to repair the fence</i>	<i>dimensionless</i>	<i>0 - 2 (1.1)</i>	<i>Pests and Disease</i>
206.	<i>PD_HalfFenceTime</i>	<i>Time constant of decay of fence quality: time interval after which quality is reduced by 50%</i>	<i>days</i>	<i>0 - 365 (50)</i>	<i>Pest and Disease</i>
207.	<i>PD_JumptheFence?[animals]</i>	<i>The degree to which animals are deterred by a fence from entering the plot</i>	-	<i>0 - 1 (0)</i>	<i>Pest and Diseases</i>
208.	<i>PD_PopDensOutside[animals]</i>	<i>Population density outside the plot, influencing the presence</i>	-	<i>0 or 1</i>	<i>Pest and Diseases</i>
209.	<i>PD_TEatenBy?[Animals]</i>	<i>A switch determining tree attacks by specific animals. Default animals are pigs, monkey, locust, nematode, goat, buffalo and birds. 0 = no attack, 1 = attacked</i>	<i>0 or 1 (0)</i>	<i>0 - 1 (0)</i>	<i>(Tree parameters/ Pest Impacts)</i>
210.	<i>PD_TFrugivore?[Animals]</i>	<i>A switch determining the presence of attack by each default animal. 0 = animals is not a tree frugivore, 1 = animal is frugivore</i>	<i>dimensionless</i>	<i>0 or 1 (0)</i>	<i>Pest and Disease</i>
211.	<i>PD_Tfrugivory&Abort[Tree]</i>	<i>Constant daily fraction of tree fruit biomass removed due to the action of frugivores</i>	-	<i>0 - 1 (0)</i>	<i>Pest and Diseases</i>
212.	<i>PD_THerbivore?[Animals]</i>	<i>A switch determining the presence of attack by each default animal. 0 = animals is not a tree herbivore, 1 = animal is herbivore</i>	<i>dimensionless</i>	<i>0 or 1 (0)</i>	<i>Pest and Disease</i>
213.	<i>PD_THerbivory[Tree]</i>	<i>Constant daily fraction of tree leaf biomass removed due to the action of herbivores</i>	-	<i>0 - 1 (0)</i>	<i>Pest and Diseases</i>
214.	<i>PD_TLignivory[Tree]</i>	<i>Constant daily fraction of tree woody stem biomass removed due to the action of lignivores</i>	-	<i>0 - 1 (0)</i>	<i>Pest and Diseases</i>
215.	<i>PD_TLignivore?[Animals]</i>	<i>A switch determining the presence of attack by each default animal. 0 = animals is not a tree lignivore, 1 = animal is lignivore</i>	<i>dimensionless</i>	<i>0 or 1 (0)</i>	<i>Pest and Disease</i>

No	Acronym	Definition	Dimensions	Range of value (Default value)	Input Section (Link location in Excel)
215.	<i>PD_TRhizovore?[Animals]</i>	<i>A switch determining the presence of attack by each default animal. 0 = animals is not a tree rhizovore, 1 = animal is rhizovore</i>	<i>dimensionless</i>	<i>0 or 1 (0)</i>	<i>Pest and Disease</i>
216.	<i>PD_TRhizovory[Tree]</i>	<i>Constant daily fraction of tree root biomass removed due to the action of rhizovores</i>	-	<i>0 - 1 (0)</i>	<i>Pest and Diseases</i>
217.	Rain_AType	A number 1, 2 or 3 to decide rainfall rate (1= rainfall rate follows precipitation data from external file, rainfall rate follows tabulated data, 2 = rainfall rate follows random generator, 3= rainfall rate follows tabulated monthly total data)	dimensionless	1, 2 or 3 (1)	Rainfall
218.	Rain_BoundHeali	Boundary value between heavy and light rain (only for Rain_AType=1)	mm	20 - 30 (25)	Rainfall
219.	Rain_CoeffVar2	Coefficient variation of rainfall in mm, used in rainfall generated randomly (Rain_Atype=2)	dimensionless	0 - 1 (.05)	Rainfall
220.	Rain_CoeffVar3	Coefficient variation of rainfall in mm, rainfall based on tabulated monthly rainfall (Rain_Atype=3)	dimensionless	0 - 1 (.05)	Rainfall
221.	Rain_Cycle?	Parameter governing ways to read rainfall data. Corresponds to Rain_AType=1 (0 = use multiple year rainfall data, 1 = use 1 year data in cycle/continuously)	dimensionless	0 or 1 (1)	Rainfall
222.	Rain_Data	Actual daily rainfall data. Entered as graphical function or read from WaNuLCAS.XLS (Stella non-CRT users only). Corresponds to Rain_AType=1.	mm	(see table in excel sheet weather)	(WEATHER)
223.	Rain_DayP	Probability of raining each day as a function of Julian day scaled monthly. Corresponds to Rain_AType=2 and 3.	dimensionless	0 - 1 (.32)	Rainfall

No	Acronym	Definition	Dimensions	Range of value (Default value)	Input Section (Link location in Excel)
224.	Rain_GenSeed	Seed Random Generator. For Rain_AType=2 and 3.	dimensionless	1 - 32767 (300)	Rainfall
225.	Rain_Heavy	Average precipitation rate of on a heavy rain day; for Rain_AType=2.	mm day ⁻¹	0 - 100 (42)	Rainfall
226.	Rain_HeavyP	Probability of heavy rain; for Rain_AType=2.	dimensionless	0 - 1 (.5)	Rainfall
227.	Rain_IntensCoefVar	Coefficient variance of rain intensity. Rain intensity is a factor affecting water infiltration. It is assumes to follow normal distribution with an average of Rain_IntensMean and standard deviation $Rain_IntensMean * Rain_IntensCoefVar$	dimensionless	(.3)	Rainfall
228.	Rain_IntensMean	Average rain intensity per hour. Rain intensity is a factor affecting water infiltration. It is assumes to follow normal distribution with an average of Rain_IntensMean and standard deviation $Rain_IntensMean * Rain_IntensCoefVar$	mm hr ⁻¹	(50)	Rainfall
229.	Rain_IntercDripRt	The rate of water dripping from water on interception surface	mm hr ⁻¹	(10)	Rainfall
230.	Rain_IntMult	Indicates the maximum temporary storage of water on interception surfaces	dimensionless	(3)	Rainfall
231.	Rain_Light	Average precipitation rate of a light rain day day; for Rain_AType=2.	mm day ⁻¹	0 - 40 (9)	Rainfall
232.	Rain_MaxIntDripDur	Maximum value of water interception delay before start to dripping	mm hr ⁻¹	(.5)	Rainfall

No	Acronym	Definition	Dimensions	Range of value (Default value)	Input Section (Link location in Excel)
233.	Rain_MonthTot	Tabulated data of monthly rainfall; for Rain_AType=3. Entered as graphical function or read from WaNuLCAS.XLS (Stella non-CRT users only).	mm month ⁻¹	(see Rain_MonthTot graph)	Rainfall
234.	Rain_Multiplier	Multiplier of rainfall for quick modifications of rainfall amount	dimensionless	0 - 4 (1)	RUN & OUTPUT SECTION
235.	Rain_PondFlwRt	The rate at which water ponding on the surface will actually flow to a neighbouring zone or plot	mm hr ⁻¹ per m of zone width	(10)	Rainfall
236.	Rain_PondStoreCp	The storage capacity of water ponding on the surface	mm	(5)	Rainfall
237.	Rain_Weight[Zone]	Input weight value to decide amount of rain falling on each zone relative to other zones (eg. equal rainfall in each zone on area basis means 1:1:1:1)	dimensionless	0 - 10 (1)	Rainfall
238.	Rain_YearStart	Initial year based on rainfall data at which simulation starts	dimensionless	any integer value (0)	Rainfall
239.	Rt_ACType	Parameter governing type of root density data for crop. 0=Lrv data available, 1=Lrv calculated using exponential function model where length root area is constant, 2= Lrv calculated using exponential function model where length root area is derived from root biomass	dimensionless	0, 1, or 2 (0)	Roots and Mycorrhiza/ Crop Root
240.	Rt_ATType	Parameter governing type of root density data for tree. 0=Lrv data available, 1=Lrv is constant calculated using elliptical function model, 2= Lrv is calculated using elliptical function but dynamically changes according to water or N stress	dimensionless	0, 1 or 2 (0)	Roots and Mycorrhiza/ Tree Root

No	Acronym	Definition	Dimensions	Range of value (Default value)	Input Section (Link location in Excel)
241.	Rt_CDecDepth[Cr]	Parameter governing decrease of crop root with depth; corresponds to Rt_ACType=1 and Cq_AType.	m ⁻¹	0 - 10 (7)	(Crop Library/Roots)
242.	Rt_CDistResp[Cr]	Responsiveness of crop root distribution to the depth at which uptake of the currently limiting resource (water, N or P) is most successful. Value 0 = no response to stress, 0 - 1 = mild response, 1 = proportional change to inverse of relative depth of uptake, > 1 = strong response. Only for Rt_ACType = 2.	dimensionless	0 - 3 (1)	(Crop Library/Roots)
243.	Rt_CHalfLife[Cr]	Crop root half-life (only for Rt_ACType=2)	days	30 - 100 (50)	(Crop Library/Roots)
244.	Rt_CLraConst[Cr]	Total root length per unit area. It is used to calculate crop root density in exponential decrease model (Rt_ACType=1). Also corresponds to Cq_AType.	cm cm ⁻²	0 - 150 (100)	(Crop Library/Roots)
245.	Rt_CLrvm/[Cr]	Maximum crop root length density in <i>i</i> -th soil layer; corresponds to Rt_ACType=0 and Cq_A Type.	cm cm ⁻³	0 - 15 (layer 1 = 5, layer 2 = 3, layer 3 = .3, layer 4 = 0)	(Crop Library/Roots)
246.	Rt_CMultiplier	Multiplier of root for quick modifications of crop root length density	dimensionless	(1)	Root and Mycorrhiza
247.	Rt_CSRL[Cr]	Specific root length (length per unit dry weight) of crop roots	m g ⁻¹	50 - 100(200)	(Crop Library/Roots)
248.	Rt_MCHypDiam	Diameter of crop mycorrhizal hyphae	cm	0.001 - 0.05 (.01)	Roots & Mycorrhiza/ Mycorrhiza
249.	Rt_MCHypL	Length of crop mycorrhizal hyphae per unit infected root length	dimensionless	10 - 100 (100)	Roots & Mycorrhiza/ Mycorrhiza

No	Acronym	Definition	Dimensions	Range of value (Default value)	Input Section (Link location in Excel)
250.	Rt_MCInfFrac/ <i>i</i>	Fraction of crop roots that is mycorrhizal (infected) in <i>i</i> -th soil layer. Layer 1 = .05, layer 2 = .25, layer 3 = .05, layer 4 = 0	dimensionless	0 - 1 (see definition)	Roots & Mycorrhiza/Mycorrhiza
251.	Rt_MTHypDiam	Diameter of tree mycorrhizal hyphae	cm	0.001 - 0.05 (.01)	Roots & Mycorrhiza/Mycorrhiza
252.	Rt_MTHypL	Length of tree mycorrhizal hyphae per unit infected root length	dimensionless	10 - 100 (100)	Roots & Mycorrhiza/Mycorrhiza
253.	Rt_MTInfFrac/[Zone]	Fraction of tree roots that is mycorrhizal (infected)	dimensionless	0 - 1 (0)	Roots & Mycorrhiza/Mycorrhiza
254.	Rt_TAlloc[Tree]	Fraction of tree growth reserves allocated to roots in the absence of water or nutrient stress (only for Rt_ATType=2)	dimensionless	0 - 1 (.1)	(Tree Library/Roots)
255.	Rt_TAllocResp[Tree]	Responsiveness of tree root allocation to stress factors; 0 = constant root allocation, 1 = linear response to water and nitrogen stress, >1 more-than-proportional response (only for Rt_ACType = 2),	dimensionless	0 - 2 (2)	(Tree Library/Roots)
256.	Rt_TDecDepthC[Tree]	Parameter governing decrease of tree root with depth ; for Rt_ATType=1	m ⁻¹	0 - 10 (3)	(Tree Library/Roots)
257.	Rt_TDistResp[Tree]	Responsiveness of crop root distribution to the depth at which uptake of the currently limiting resource (water, N or P) is most successful. Value 0 = no response to stress, 0 - 1 = mild response, 1 = proportional change to inverse of relative depth of uptake, > 1 = strong response. Only for Rt_ACType = 2.	dimensionless	0 - 5 (2)	(Tree Library/Roots)

No	Acronym	Definition	Dimensions	Range of value (Default value)	Input Section (Link location in Excel)
258.	Rt_TDistShapeC[Tree]	Tree root distribution shape for Rt_ATTtype=1 and 2; for a value of 1 root length density decreases as much with horizontal as with vertical distance to the tree stem	dimensionless	0 - 2 (.05)	(Tree Library/Roots)
259.	Rt_THalfLife[Tree]	Tree root half life (only for Rt_ATTtype=2)	days	30 - 150 (60)	(Tree Library/Roots)
260.	Rt_THostEffForT1[Tree]	<i>An option for simulation root parasitism tree 1 on others tree root</i>	<i>dimensionless</i>	<i>(0)</i>	<i>Root Parasitism</i>
261.	Rt_TLengDiam1[Tree]	Length of (branch) roots of a tree root with a proximal (at stem base) diameter of 1 cm; Intercept (a) of allometric equation (RootLength = a StemDiameter ^b). Calculation from Functional Branch Analysis (FBA). Input needed to run FBA refer to tree parameterization	cm	0.01 - 1 (10)	(Tree Library/Roots)
262.	Rt_TLengDiamSlope [Tree]	Power coefficient (b) of allometric equation (RootLength = a StemDiameter ^b). Calculation from Functional Branch Analysis (FBA). Input needed to run FBA refer to tree parameterization	dimensionless	1 - 3 (1.5)	(Tree Library/Roots)
263.	Rt_TLraX0[Tree]	Total root length per unit area at X(distance to tree)=0 (tree stem). for Rt_ATTtype=1	cm	0 - 150 (1)	(Tree Library/Roots)
264.	Rt_TLrvData/[Zone,Tree]	Tree root density in soil layer <i>i</i> in each zone; for Rt_ATTtype=0	cm cm ⁻²	0 - 15 (see excel sheet Tree Library/Roots)	(Tree Library/Roots)
265.	Rt_TMultiplier	Multiplier of root for quick modifications of tree root length density	dimensioless	(1)	Root and Mycorrhiza

No	Acronym	Definition	Dimensions	Range of value (Default value)	Input Section (Link location in Excel)
266.	Rt_TProxGini	Distribution coefficient of proximal root diameters (CumFreq = (Diam/Diammax)TProxGini of a tree, used in calculation of the specific root length of a tree root system	dimensionless	0.001 - 10 (.3)	(Tree Library/Roots)
267.	Rt_TWghtDiam1[Tree]	Biomass of a (branched) tree root with a proximal (at stem base) diameter of 1 cm; Intercept (a) of allometric equation (Root weight = a StemDiameter ^b). Calculation from Functional Branch Analysis (FBA). Input needed to run FBA refer to tree parameterization	kg	0.01 - 1 (.5)	(Tree Library/Roots)
268.	Rt_TWghtDiamSlope [Tree]	Power coefficient (b) of allometric equation (RootWeight = a StemDiameter ^b). Calculation from Functional Branch Analysis (FBA). Input needed to run FBA refer to tree parameterization	dimensionless	1 - 3 (2.3)	(Tree Library/Roots)
269.	S&B_2ndFireafterPileup	<i>Number of days between pile up and secondary burn event</i>	<i>days</i>	<i>1 - 100 (5)</i>	<i>Management/ Slash and Burn</i>
270.	S&B_CritMoist	<i>Limit value for internal + adhering (intercepted from rainfall) moisture content of slashed necromass; below this value necromass is categorized as dry and fire can take place</i>	<i>l kg⁻¹</i>	<i>0 - 1 (.05)</i>	<i>Management/ Slash and Burn</i>
271.	S&B_DeadWoodFuelFact	<i>Temperature of the fire per unit dry weight of fuel in dead wood</i>	<i>°C kg⁻¹</i>	<i>0 - 100 (.1)</i>	<i>Management/ Slash and Burn</i>
272.	S&B_FirImpPSorption	<i>Fire impacts on P sorption, as a function of soil surface temperature increase</i>	<i>dimensionless</i>	<i>(see table in excel sheet Slash& Burn)</i>	<i>Management/ Slash and Burn</i>

No	Acronym	Definition	Dimensions	Range of value (Default value)	Input Section (Link location in Excel)
273.	<i>S&B_FirIndPMobiliz</i>	<i>Fire impact on mobilization fraction of P from the inorganic P immobile pool, as a function of soil surface temperature increase</i>	<i>dimensionless</i>	<i>(see table in excel sheet Slash& Burn)</i>	<i>Management/ Slash and Burn</i>
274.	<i>S&B_FirMortSeedBank</i>	<i>Fractional mortality in the weed seed bank as a function of soil surface temperature increment</i>	<i>dimensionless</i>	<i>(see table in excel sheet Slash& Burn)</i>	<i>Management/ Slash and Burn</i>
275.	<i>S&B_FuelLoadFactor</i>	<i>Temperature of the fire per unit dry weight of fuel in slashed necromass and structural surface litter</i>	<i>°C kg¹</i>	<i>0 - 100 (10)</i>	<i>Management/ Slash and Burn</i>
276.	<i>S&B_MaxDryingPer</i>	<i>The latest time after slashing when fire can occur; if the fuel does not get dry enough before this time, no fire will be occur</i>	<i>days</i>	<i>1 - 200 (30)</i>	<i>Management/ Slash and Burn</i>
277.	<i>S&B_MinDryingPer</i>	<i>The earliest time after slashing that fire can occur</i>	<i>days</i>	<i>0 - 100 (20)</i>	<i>Management/ Slash and Burn</i>
278.	<i>S&B_NecroBurnFrac</i>	<i>Fraction of surface necromass burnt as a function of fire temperature at the soil surface.</i>	<i>dimensionless</i>	<i>(see table in excel sheet Slash& Burn)</i>	<i>Management/ Slash and Burn</i>
279.	<i>S&B_NutVolatFracN</i>	<i>Volatilization fraction of N in the burnt necromass, as a function of soil surface temperature increment</i>	<i>dimensionless</i>	<i>(see table in excel sheet Slash& Burn)</i>	<i>(Slash&Burn)</i>
280.	<i>S&B_NutVolatFracP</i>	<i>Volatilization fraction of P in the burnt necromass, as function of soil surface temperature increment</i>	<i>dimensionless</i>	<i>(see table in excel sheet Slash& Burn)</i>	<i>(Slash & Burn)</i>

No	Acronym	Definition	Dimensions	Range of value (Default value)	Input Section (Link location in Excel)
281.	<i>S&B_pHRecFrac</i>	<i>Daily recovery fraction of soil pH in the topsoil from its post-fire towards its pre-fire value</i>	<i>fraction</i>	<i>0.001-0.1 (.01)</i>	<i>Management/Slash and Burn</i>
282.	<i>S&B_PSorpRecFrac</i>	<i>Daily recovery fraction of the P_sorption in the topsoil from its post-fire towards its pre-fire value</i>	<i>fraction</i>	<i>0.001-0.1 (.01)</i>	<i>Management/Slash and Burn</i>
283.	<i>S&B_ScorchWRemFra</i>	<i>Fraction of scorched wood removed after slash and burn event</i>	<i>fraction</i>	<i>0 - 1 (.3)</i>	<i>Management/Slash and Burn</i>
284.	<i>S&B_SlashDOY</i>	<i>A graphical input tabulating day of year at which slashing is performed</i>	<i>julian days</i>	<i>(see S&B_SlashDOY graph)</i>	<i>Management/Slash and Burn</i>
285.	<i>S&B_SlashYear</i>	<i>A graphical input tabulating year at which slashing is performed</i>	<i>dimensionless</i>	<i>any integer value (100)</i>	<i>Management/Slash and Burn</i>
286.	<i>S&B_SOMBurnFrac</i>	<i>Fraction of all SOM pools in the topsoil (Layer 1) respired (C) or mineralized (N & P) as a function of soil surface temperature increment</i>	<i>dimensionless</i>	<i>(see table in excel sheet Slash&Burn)</i>	<i>Management/Slash and Burn</i>
287.	<i>S&B_SurfLitBurnFrac</i>	<i>Fraction of all surface litter respired (C) or mineralized (N & P) as a function of soil surface temperature increment</i>	<i>dimensionless</i>	<i>(see table in excel sheet Slash&Burn)</i>	<i>Management/Slash and Burn</i>
288.	<i>S&B_TimetoPileUp</i>	<i>Number of days between primary burn and pile up (redistribution across the zones) for a secondary burn</i>	<i>days</i>	<i>1 - 100 (15)</i>	<i>Management/Slash and Burn</i>
289.	<i>S&B_TimetoWoodRem</i>	<i>Number of days between primary burn and removal of scorched wood</i>	<i>days</i>	<i>1 - 50 (10)</i>	<i>Management/Slash and Burn</i>
290.	<i>S&B_TTempTol[Tree]</i>	<i>Maximum fire temperature that a tree can tolerate. Temperature above the value will induce tree mortality</i>	<i>°C</i>	<i>40 - 90 (75)</i>	<i>(Tree Library/Slash&Burn)</i>
291.	<i>S&B_WatRetRecFrac</i>	<i>Daily recovery fraction of soil water retention in the topsoil from its post-fire towards its pre-fire value</i>	<i>fraction</i>	<i>0.001 - 0.1 (0.005)</i>	<i>Management/Slash and Burn</i>

No	Acronym	Definition	Dimensions	Range of value (Default value)	Input Section (Link location in Excel)
292.	<i>S&B_WetnessTempImp</i>	<i>Fractional reduction in fire temperature per unit of moisture content of the fuel</i>	<i>fraction</i>	<i>0 – 1 (.5)</i>	<i>Management/ Slash and Burn</i>
293.	<i>S_C_RtStrucFormFrac</i>	<i>Fraction of contribution of crop root decay on root channels</i>	<i>fraction per m</i>	<i>(.1)</i>	<i>Soil Structure</i>
294.	<i>S_KSatDefVi</i>	Saturated hydraulic conductivity of the soil in the absence of macropore structure, as derived from texture-based pedotransfer functions. Read and calculation from WaNuLCAS.XLS. Input needed to run pedotransfer refer to the sheet pedotransfer. Layer 1 = 319, layer 2 = 54, layer 3 = 45, layer 4 = 40	cm day ⁻¹	1 – 500 (see definition)	(Soil Hydraulic)
295.	<i>S_KSatHperVi</i>	<i>Ratio of saturated hydraulic conductivity in horizontal and vertical direction for layer i</i>	<i>dimensionless</i>	<i>0 – 5 (1)</i>	<i>Soil Structure/ K Sat ratio</i>
296.	<i>S_KSatInitVi[Zone]</i>	<i>Saturated hydraulic conductivity of the soil at the macropore structure existing at the start of the simulation. Read and calculation from WANULCAS.XLS. Input needed to run pedotransfer refer to the sheet pedotransfer. Layer 1 = 319, layer 2 = 54, layer 3 = 45, layer 4 = 40</i>	<i>cm day-1</i>	<i>1 – 500 (see definition)</i>	<i>(Soil Hydraulic)</i>
297.	<i>S_KSatVDeepSub</i>	<i>Saturated hydraulic conductivity of the soil below layer 4, determining the rate of vertical drainage from the soil column</i>	<i>cm day-1</i>	<i>1 – 100 (20)</i>	<i>Soil Structure</i>
298.	<i>S_BDBDRefDecay</i>	<i>Relative rate of decay of the bulk density, returning the surface infiltration rate toward S_SurfInfiltrPerKsatDef and the saturated hydraulic conductivity towards S_KSatDefV</i>	<i>day-1</i>	<i>0 – 0.1 (.001)</i>	<i>Soil Structure</i>
299.	<i>S_ReIWormLiti</i>	<i>Relative impact of 'worms' (soil fauna) on increase of saturated hydraulic conductivity in each layer</i>	<i>dimensionless</i>	<i>0 – 1 (1, 0.6, 0.3, 0.1)</i>	<i>Soil Structure</i>

No	Acronym	Definition	Dimensions	Range of value (Default value)	Input Section (Link location in Excel)
300.	<i>S_RelWormSurf</i>	<i>Relative impact of 'worms' (soil fauna) increase of infiltration rate of the soil surface</i>	<i>dimensionless</i>	<i>0 - 1 (1)</i>	<i>Soil Structure</i>
301.	<i>S_SoilStructDyn?</i>	<i>Switch determining dynamics of soil structure (0 = false, 1 = true) based on decay and re-creation of macropores by soil fauna above the texture-based default values</i>	<i>day⁻¹</i>	<i>0 or 1 (0)</i>	<i>Soil Structure</i>
302.	<i>S_SurfInfiltrPerKsatDef [Zone]</i>	<i>Ratio of surface infiltration and Ksat for the first soil layer in the default condition of the soil as defined by the pedotransfer function</i>	<i>mm day⁻¹</i>	<i>25 - 10000 (25)</i>	<i>Soil Structure</i>
303.	<i>S_RelSurfInfiltrInit[Zone]</i>	<i>Surface infiltration rate at the start of the simulation relative to its default value</i>	<i>mm day⁻¹</i>	<i>100 - 10000 (1000)</i>	<i>Soil Structure</i>
304.	<i>S_T_RtStrucFormFrac</i>	<i>Fraction of contribution of tree root decay on root channels</i>	<i>fraction per m</i>	<i>(.3)</i>	<i>Soil Structure</i>
305.	<i>S_WormsLikeLitMetab</i>	<i>Activity (in arbitrary units) of soil fauna ("worms") per unit of organic inputs in the litter metabolic pool</i>	<i>m² kg⁻¹</i>	<i>0.00001 - 0.1 (.00001)</i>	<i>Soil Structure</i>
306.	<i>S_WormsLikeLitStruc</i>	<i>Activity (in arbitrary units) of soil fauna ("worms") per unit of organic inputs in the litter structural pool</i>	<i>m² kg⁻¹</i>	<i>0.0000005 - 0.1 (.0000005)</i>	<i>Soil Structure</i>
307.	<i>S_WormsLikeSOMMetab</i>	<i>Activity (in arbitrary units) of soil fauna ("worms") per unit of organic inputs in the SOM metabolic pool</i>	<i>m² kg⁻¹</i>	<i>0.000001 - 0.1 (.000001)</i>	<i>Soil Structure</i>
308.	<i>S_WormsLikeSOMStruc</i>	<i>Activity (in arbitrary units) of soil fauna ("worms") per unit of organic inputs in the SOM structural pool</i>	<i>m² kg⁻¹</i>	<i>0.00000005 - 0.1 (.00000005)</i>	<i>Soil Structure</i>
309.	<i>T_ApplyFBA?[Tree]</i>	<i>Switch (1 = yes, 0 = no) to determine whether the allocation of biomass from the canopy to the wood (branches + stem) pools is governed by the fractal branching parameters (allometric equations).</i>	<i>dimensionless</i>	<i>0 or 1 (1)</i>	<i>Tree Parameters</i>

No	Acronym	Definition	Dimensions	Range of value (Default value)	Input Section (Link location in Excel)
310.	T_ApplyPalm?[Tree]	Switch (1 = yes, 0 = no) to determine whether the allocation of biomass to storage pool follows oil palm rule.	dimensionless	0 or 1 (0)	(Tree Library/Fruit)
311.	T_CanBiomInit[Tree]	Initial amount of biomass in tree canopy (leaf and small stems)	kg m ⁻²	0 - 1 (0)	Tree parameters
312.	T_CanHMax[Tree]	Maximum height of tree canopy	m	0 - 15 (8.2)	(Tree Library/Canopy)
313.	T_CanShape[Tree]	Factor determining in which part of the tree leaves are concentrated. A value of 1 gives an even spread of tree leaves over the alley, a higher value (eg 2) concentrates tree leaves above the hedgerow	dimensionless	0 - 2 (.567)	(Tree Library/Canopy)
314.	T_CanWidthMax[Tree]	Maximum tree canopy width, half the canopy width (radius).	m	0 - 10 (4.655)	(Tree Library/Canopy)
315.	T_ConcFruit[SiNut, Tree]	Nutrient concentration in fruit component	dimensionless	0 - 0.1 (N = .02, P = .002)	(Tree Library/N-P concentration)
316.	T_ConcGroRes [SiNut, Tree]	Nutrient concentration in carbohydrate reserves	dimensionless	0 - 0.1 (N = .01, P = .0005)	(Tree Library/N-P concentration)
317.	T_ConcLf[SiNut, Tree]	N concentration in leaf component of tree	dimensionless	0 - 0.1 (N = .0173, P = .0009)	(Tree Library/N-P concentration)
318.	T_ConcRt[SiNut, Tree]	Nutrient concentration in tree roots (only for Rt_ATTtype=2)	dimensionless	0 - 0.1 (N = .0122, P = .0006)	(Tree Library/N-P concentration)
319.	T_ConcTwig[SiNut, Tree]	Nutrient concentration in twig component of tree	dimensionless	0 - 0.1 (N = .00073, P = .0016)	(Tree Library/N-P concentration)

No	Acronym	Definition	Dimensions	Range of value (Default value)	Input Section (Link location in Excel)
320.	T_ConcWood [SiNut, Tree]	Nutrient concentration in wood component of tree	dimensionless	0 - 0.1 (N = .0047, P = .0008)	(Tree Library/ N-P concentration)
321.	T_DiamBiom1[Tree]	Biomass of a tree of diameter 1 cm; Intercept (a) of allometric equation (Branch biomass = a StemDiameter ^b). Calculation from Functional Branch Analysis (FBA). Input needed to run FBA refer to tree parameterization	kg	0.01 - 1 (.6513)	(Tree Library/ Allometric branching)
322.	T_DiamBranch1[Tree]	Intercept (a) of allometric equation (Tree branch biomass = a Diameter ^b). Calculation from Functional Branch Analysis (FBA). Input needed to run FBA refer to tree parameterization	kg	0.01 - 1 (.0334)	(Tree Library/ Allometric branching)
323.	T_DiamCumLit1[Tree]	Cumulative litterfall expected for a stem diameter of 1 cm. Calculation from Functional Branch Analysis (FBA). Input needed to run FBA refer to tree parameterization	kg	0.01 - 1 (.0302)	(Tree Library/ Allometric branching)
324.	T_DiamLfTwig1[Tree]	Intercept (a) of allometric equation (Leaf & Twig biomass = a StemDiameter ^b). Calculation from Functional Branch Analysis (FBA). Input needed to run FBA refer to tree parameterization	kg	0.01 - 1 (.9656)	(Tree Library/ Allometric branching)
325.	T_DiamSlopeBiom[Tree]	Power coefficient (b) of allometric equation (Branch biomass = a StemDiameter ^b). Calculation from Functional Branch Analysis (FBA). Input needed to run FBA refer to tree parameterization	cm ⁻¹	0 - 3 (2.0937)	(Tree Library/ Allometric branching)
326.	T_DiamSlopeBranch [Tree]	Power coefficient (b) of allometric equation (Tree branch biomass = a Diameter ^b). Calculation from Functional Branch Analysis (FBA). Input needed to run FBA refer to tree parameterization	cm ⁻¹	0 - 3 (2.4195)	(Tree Library/ Allometric branching)

No	Acronym	Definition	Dimensions	Range of value (Default value)	Input Section (Link location in Excel)
327.	T_DiamSlopeCumLit [Tree]	Power coefficient (b) of the allometric equation describing the increase of cumulative litterfall with stem diameter. Calculation from Functional Branch Analysis (FBA). Input needed to run FBA refer to tree parameterization	cm ⁻¹	0 - 3 (3.0937)	(Tree Library/ Allometric branching)
328.	T_DiamSlopeLFTwig [Tree]	Power coefficient (b) of allometric equation (Leaf&Twig biomass = a StemDiameter ^b). Calculation from Functional Branch Analysis (FBA). Input needed to run FBA refer to tree parameterization	dimensionless	1 - 3 (1.7270)	(Tree Library/ Allometric branching)
329.	T_DiamTreshHarv[Tree]	<i>Tree diameter of timber harvested</i>	<i>cm</i>	<i>100</i>	<i>Management/ Timber Harvesting</i>
330.	T_DOY 1 LfFlush[Tree]	<i>Day of the first cycle of leaf flush</i>	<i>julian days</i>	<i>1 - 365 (1)</i>	<i>Tree parameters/ Tree leaf phenology</i>
331.	T_DOY 2 LfFlush[Tree]	<i>Day of the second cycle of leaf flush</i>	<i>julian days</i>	<i>1 - 365 (400)</i>	<i>Tree parameters/ Tree leaf phenology</i>
332.	T_DOY SeaLitFall1Start [Tree]	<i>Day when the first season of leaf starts dropdown</i>	<i>julian days</i>	<i>1 - 365 (400)</i>	<i>Tree parameters/ Tree leaf phenology</i>
333.	T_DOY SeaLitFall2Start [Tree]	<i>Day when the second season of leaf starts dropdown</i>	<i>julian days</i>	<i>1 - 365 (400)</i>	<i>Tree parameters/ Tree leaf phenology</i>
334.	T_DOY_Comp1LlFall [Tree]	<i>Day when the first season of leaf completely dropdown</i>	<i>julian days</i>	<i>1 - 365 (400)</i>	<i>Tree parameters/ Tree leaf phenology</i>
335.	T_DOY_Comp12LlFall [Tree]	<i>Day when the second season of leaf completely dropdown</i>	<i>julian days</i>	<i>1 - 365 (400)</i>	<i>Tree parameters/ Tree leaf phenology</i>
336.	T_DOYFlwBeg[Tree]	The earliest day in a year when tree start to flowers	julian days	1 - 365 (200)	(Tree Library/ Growth stage)

No	Acronym	Definition	Dimensions	Range of value (Default value)	Input Section (Link location in Excel)
337.	T_DOYFlwEnd[Tree]	The latest day in a year when tree start to flowers	julian days	1 - 365 (250)	(Tree Library/ Growth stage)
338.	T_FracSeaLitFall1[Tree]	Fraction of tree canopy become litterfall	dimensionless	0 - 1 (1)	(Tree parameter/ Tree leaf phenology)
339.	T_FruitAllocMax[Tree]	Allocation of biomass to fruit each day	kg m ⁻² day ⁻¹	0 - 1 (0)	(Tree Library/Fruit)
340.	T_FruitAllocStage[Tree]	Graphical input parameter as a function of tree stage that determine how much fruit will produce from maximum fruit allocation	dimensionless	0 - 1 (see T_FruitAllocStage graph)	Management/ Fruit Harvesting
341.	T_FruitHarvFrac[Tree]	Harvest index for fruit. Constant value for every fruiting season	dimensionless	0 - 1 (0)	Management/ Fruit Harvesting
342.	T_FruitMoistFrac[Tree]	Standard moisture content for expressing marketable fruit of each tree	dimensionless	0 - 1 (0)	(Tree Library/Fruit)
343.	T_GenLitFracMax[Tree]	Fraction of fruit will drop	dimensionless	0 - 1 (.05)	Management/ Fruit Harvesting
344.	T_GenLitStage[Tree]	Graphical input parameter as a function of tree stage that determine how many fruit will drop	dimensionless	0 - 1 (see T_GenLitStage graph)	Management/ Fruit Harvesting
345.	T_GraphPhenol?[Tree]	Parameter governing an option to simulate tree phenology using graph. Value 0 means tree phenology using phenology parameters, value 1 means tree phenology using graph	dimensionless	0 or 1 (0)	Tree parameter/ Tree leaf phenology
346.	T_GroMax[Tree]	Maximum growth rate of hedgerows at full canopy closure	kg m ⁻² day ⁻¹	0 - 0.1 (.014)	(Tree Library/ Growth)
347.	T_GroResFrac[Tree]	Fraction of tree carbohydrate reserves converted to biomass during regrowth stage after pruning	day ⁻¹	0 - 0.5 (.025)	(Tree Library/ Growth)

No	Acronym	Definition	Dimensions	Range of value (Default value)	Input Section (Link location in Excel)
348.	T_GroResInit[Tree]	Initial amount of tree carbohydrates as reserves of tree potential growth	kg per tree	0 - 1 (0.25)	Tree parameters
349.	T_HeartWoodAllocAft Pruned?	<i>Parameter governing an option to simulate heartwood. Value 0 means after pruning no sapwood biomass that allocated to heartwood biomass, value 1 means after pruning all sapwood biomass allocated to heartwood biomass.</i>	<i>dimensionless</i>	<i>(0)</i>	<i>Tree parameter/ Tree stem (sapwood & heartwood)</i>
350.	T_InitStage[Tree]	Initial stage of tree when it was planted. If tree already growing at the start of simulation, it is the stage at the start of simulation time	dimensionless	0 - 2 (0)	(Tree Library/ Growth stage)
351.	T_KillDOY[Tree]	<i>Schedule date, day of year to kill tree</i>	<i>julian days</i>	<i>1 - 365 (1)</i>	<i>Management/ Killing Trees</i>
352.	T_KillY[Tree]	<i>Schedule date, year to kill tree</i>	<i>dimensionless</i>	<i>any integer value (1000)</i>	<i>Management/ Killing Trees</i>
353.	T_KLight[Tree]	Tree canopy (leaves component) extinction light coefficient = the efficiency of tree foliage in absorbing light	dimensionless	0 - 1 (.7)	(Tree Parameters/ Light Capture)
354.	T_LatexMoistFrac[Tree]	<i>Standard moisture content for expressing marketable latex of each tree</i>	<i>dimensionless</i>	<i>0 - 1 (0)</i>	<i>(Tree Library)</i>
355.	T_LAIMax[Tree]	Maximum value of LAI in the tree canopy	dimensionless	0 - 5 (4)	(Tree Library/ Canopy)
356.	T_LAIMinMaxRatio[Tree]	Parameter describing canopy thickness/dense. Value 1 is maximum thickness	dimensionless	0 - 1 (1)	(Tree Library/ Canopy)
357.	T_LifallDroughtFrac[Tree]	Fraction of tree biomass becomes litterfall due to drought	day ⁻¹	0 - 1 (.01)	(Tree Library/ Litterfall)
358.	T_LifallThreshWStress [Tree]	Threshold value for tree litterfall due to drought	dimensionless	0 - 1 (.7)	(Tree Library/ Litterfall)

No	Acronym	Definition	Dimensions	Range of value (Default value)	Input Section (Link location in Excel)
359.	T_LifallWeight[Zone]	Input weight value governing amount of tree litterfall going into each zone relative to other zones (eg. 1:1:1:1 means equal mulch given in each zones on area basis)	dimensionless	0 - 10 (1,1, 1, 1)	Litterfall
360.	T_LignLifall[Tree]	Lignin concentration of tree litterfall (eg. 20%=0.2)	dimensionless	0 - 1 (.43)	(Tree Library/ Litter Quality)
361.	T_LignPrun[Tree]	Lignin concentration of pruned tree biomass (eg. 20%=0.2)	dimensionless	0 - 1 (.4)	(Tree Library/ Litter Quality)
362.	T_LignRt[Tree]	Lignin concentration of tree root	dimensionless	0 - 1 (.4)	(Tree Library/ Litter Quality)
363.	T_LWR[Tree]	Leaf Weight Ratio = leaf dry weight per unit shoot dry weight	dimensionless	0 - 5 (.494)	(Tree Library/ Growth)
364.	T_MycMaxInf[Tree]	<i>Fraction of tree roots infected by mycorrhiza for a soil layer where the Rt_MTInFrac parameter is 1</i>	<i>dimensionless</i>	<i>0 - 1 (.3)</i>	<i>(Tree Library/ Mycorrhiza)</i>
365.	T_NFixDayFrac[Tree]	Fraction of current N deficit derived from atmospheric N ₂ fixation per day for each tree if T_NFixVariable = 1 ('true')	day ⁻¹	0 - 1 (.125)	(Tree Library/ N Fixation)
366.	T_NFixDWMaxFrac[Tree]	Maximum fraction of the T_GroRes[Dw] pool that can be respired for N ₂ fixation if T_NFixVariable = 0 ('false')	day ⁻¹	0 - 0.5 (.05)	(Tree Library/ N Fixation)
367.	T_NFixDWUnitCost[Tree]	Dry weight cost for respiration per unit N ₂ fixation, if T_NFixVariable = 0 ('false')	kg [dw] g ⁻¹ [N]	0 - 1 (0)	(Tree Library/ N Fixation)
368.	T_NFixResp[Tree]	Responsiveness of N ₂ fixation to N stress (N in biomass divided by N target), if T_NFixVariable = 0 ('false')	dimensionless	0 - 5 (0)	(Tree Library/ N Fixation)
369.	T_NFixVariable?[Tree]	Switch (0 = false, 1 = true) to choose between variable (N-stress dependent) versus constant N ₂ fixation as fraction of N deficit	dimensionless	0 or 1 (0)	(Tree Library/ N Fixation)

No	Acronym	Definition	Dimensions	Range of value (Default value)	Input Section (Link location in Excel)
370.	T_NlIfallRed [SiNut, Tree]	Reducing factor for nutrient concentration of tree litterfall which depend on type of tree	dimensionless	0 - 2 (.7 for N and P)	(Tree Library/ Litterfall)
371.	T_NutMobT[SiNut]	<i>Relative rate of transfer, per unit root length density (cm cm⁻³), from the 'immobile' pool of nutrients to the 'mobile' or sorbed pool, due to Crop root activity</i>	m ² day ⁻¹	0 - 0.02 (0)	(Tree Library/Root Impacts on Nutrient Mobility)
372.	T_PlantDOY[Tree]	Schedule for date of planting time. Entered from WaNuLCAS.XLS	julian days	1 - 365 (see table in excel sheet Tree Management)	(Tree Management)
373.	T_PlantY[Tree]	Schedule for year of planting time. Entered from WaNuLCAS.XLS	dimensionless	any integer value (see table in excel sheet Tree Management)	(Tree Management)
374.	T_PolypLifall[Tree]	Polyphenol concentration of tree litterfall (eg. 3 %=0.03)	dimensionless	0 - 1 (0)	(Tree Library/ Litter Quality)
375.	T_PolypPrun[Tree]	Polyphenol concentration of pruned tree biomass (eg. 3 %=0.03)	dimensionless	0 - 1 (0)	(Tree Library/ Litter Quality)
376.	T_PolypRt[Tree]	Polyphenol concentration of tree root	dimensionless	0 - 1 (0)	(Tree Library/ Litter Quality)
377.	T_PrunDoY[Tree]	<i>Schedule for date of pruning. Entered from WaNuLCAS.XLS</i>	julian days	1 - 365 (365)	(Tree Management)
378.	T_PrunFracC[Tree]	<i>Fraction of canopy that gets pruned, for T_PrunType = 0. Constant for every pruning</i>	dimensionless	0 - 1 (0)	Managements/ PruningEvents
379.	T_PrunFracC[Tree]	<i>Fraction of tree canopy gets pruned, for T_PrunFrac? = 0</i>	dimensionless	0 - 1 (1)	Management/ PruningEvents

No	Acronym	Definition	Dimensions	Range of value (Default value)	Input Section (Link location in Excel)
380.	<i>T_PrunFracD[Tree]</i>	<i>Fraction of tree canopy that gets pruned, for T_PrunFrac? = 1</i>	<i>dimensionless</i>	<i>0 - 1 (1)</i>	<i>(Tree Management)</i>
381.	<i>T_PrunHarvFracC[Tree]</i>	<i>Fraction of pruned canopy that harvested (not return to the system), for T_PrunType? = 0. Constant for every pruning.</i>	<i>dimensionless</i>	<i>0 - 1 (0)</i>	<i>Managements/ PruningEvents</i>
382.	<i>T_PrunHarvFracD[Tree]</i>	<i>Fraction of tree pruned biomass harvested. Value changes overtime</i>	<i>dimensionless</i>	<i>0 or 1 (0)</i>	<i>(Tree Management)</i>
383.	<i>T_PrunLimit</i>	<i>Critical total LAI of all trees shadowing the crop zone, triggering a pruning event</i>	<i>dimensionless</i>	<i>0 - 5 (100)</i>	<i>Management/ PruningEvent</i>
384.	<i>T_PrunPlant?[Tree]</i>	<i>Parameter governing pruning decision. 1 = tree is automatically pruned before crop planting, 0 = tree does not automatically pruned</i>	<i>dimensionless</i>	<i>0 or 1 (1)</i>	<i>Management/ PruningEvent</i>
385.	<i>T_PrunRecov[Tree]</i>	<i>Time needed for tree to recover after pruning</i>	<i>days</i>	<i>0 - 30 (14)</i>	<i>Management/ PruningEvent</i>
386.	<i>T_PrunStageLimit[Tree]</i>	<i>The latest crop stage at which automatic pruning is still performed. Corresponds to T_PrunPlant? = 1</i>	<i>dimensionless</i>	<i>1 - 2 (1.8)</i>	<i>Management/ PruningEvent</i>
387.	<i>T_PrunType?</i>	<i>This parameter govern the type of pruning events. 0 = Pruning determined automatically based on canopy denseness (tree LAI). Associated with T_PrunLimit and Tree_StageLimit. 1 = Pruning determined by calender. Associated with Pruning section in sheet Tree Management, WaNuLCAS.xls</i>	<i>dimensionless</i>	<i>0 (0 or 1)</i>	<i>Managements/ PruningEvents</i>
388.	<i>T_PrunWeight [Zone,Tree]</i>	<i>Input weight value governing amount of tree pruning going into each zone relative to other zones (eg. equal pruned biomass given in each zones on area basis means 1:1:1)</i>	<i>dimensionless</i>	<i>0 - 10 (0, 1, 1, 1)</i>	<i>Management/ PruningEvent</i>

No	Acronym	Definition	Dimensions	Range of value (Default value)	Input Section (Link location in Excel)
389.	<i>T_PrunY[Tree]</i>	<i>Schedule for year of pruning. Entered from WaNuLCAS.XLS</i>	<i>dimensionless</i>	<i>any integer value (100)</i>	<i>(Tree Management)</i>
390.	<i>T_RainWStorCap[Tree]</i>	Rainfall intercepted by tree stored as thin film at leaf surface	dimensionless	(1)	(Tree Library/ Rain Interception)
391.	<i>T_RelLightMaxGr[Tree]</i>	Relative light intensity at which shading starts to affect tree growth	dimensionless	0 - 1 (.5)	(Tree Library/ Light Capture)
392.	<i>T_RhizEffKaPT</i>	Proportional reduction of the apparent adsorption constant for P due to root activity of the crop, expressed as fraction of <i>N_KaPdef</i> per unit tree root length density	m ² day ⁻¹	0 - .2 (0)	(Tree Library/ Root impacts on P mobility)
393.	<i>T_RtDiam[Tree]</i>	Tree root diameter. It is used in calculating water and nutrient uptake. For all root type.	cm	.05 - 3 (.1)	(Tree Library/Roots)
394.	<i>T_SLA[Tree]</i>	Tree specific leaf area = tree leaf surface area per unit leaf dry weight	m ² kg ⁻¹	0 - 30 (7.87)	(Tree Library/ Growth)
395.	<i>T_SapWoodScaling Rule</i>	<i>Power coefficient of conversion of diameter of sapwood to heartwood. Default value 1 means no increasing of diameter heartwood</i>	<i>dimensionless</i>	<i>0 - 1 (1)</i>	<i>Tree parameter/ Tree stem (sapwood & heartwood)</i>
396.	<i>T_SlashLabour</i>	<i>Amount of labour involved in slashing the field per unit simulated filed as a function of biomass slashed</i>	<i>person days</i>	<i>(see T_Slash Lab graph)</i>	<i>Management/ Slash and Burn</i>
397.	<i>T_SlashSellWoodFrac [Tree]</i>	<i>Indicates the fraction of wood that is removed from the plot at the time of slashing the vegetation</i>	<i>dimensionless</i>	<i>0 - 1 (0)</i>	<i>Management/ Slash and Burn</i>
398.	<i>T_StageAftPrun[Tree]</i>	<i>Tree growth stage after pruning</i>	<i>dimensionless</i>	<i>0 - 2 (1)</i>	<i>(Tree Library/ Growth stage)</i>
399.	<i>T_TimeGenCycle[Tree]</i>	Length of generative cycles of tree	days	any integer value (150)	(Tree Library/ Growth stage)

No	Acronym	Definition	Dimensions	Range of value (Default value)	Input Section (Link location in Excel)
400.	T_TimeVeg[Tree]	Length of vegetative cycles of tree	days	any integer value (720)	(Tree Library/ Growth stage)
401.	T_TranspRatio[Tree]	Amount of water needed per unit dry matter production of tree	l kg ⁻¹	0 - 500 (300)	(Tree Library/ Growth)
402.	<i>T_TranspRatioTime</i>	<i>Graphical input parameter as a function of tree stage that determine the dynamic of tree transpiration per unit biomass production</i>	-	-	<i>Tree Parameter</i>
403.	T_TreesperHa[Tree]	Tree plant density	dimensionless	any integer value (400)	Tree Parameters
404.	T_WoodBiomInit[Tree]	Initial amount of biomass in tree stem	kg m ⁻²	0 - 1 (0)	Tree Parameters
405.	T_WoodDens[Tree]	Wood density of each tree species	kg m ⁻³	(750)	(Tree Library)
406.	<i>T_WoodFrachRemain</i>	<i>Wood height remain after pruning. If you do not want to harvest wood/timber when pruning makes sure this is a high value, eg. 100.</i>	<i>m</i>	<i>0-100 (100)</i>	<i>Management/ Pruning Events/ Other Pruning Parameters</i>
407.	<i>T_WoodHarvDOY[Tree]</i>	<i>Schedule for date of pruning. Entered from WaNuLCAS.XLS</i>	<i>julian days</i>	<i>1 - 365 (364)</i>	<i>(Tree Management)</i>
408.	<i>T_WoodHarvFrac[Tree]</i>	<i>Fraction Harvested wood</i>	<i>dimensionless</i>	<i>0 - 1 (.95)</i>	<i>Management/ Timber Harvesting</i>
409.	<i>T_WoodHarvY[Tree]</i>	<i>Schedule for year of timber harvesting. Entered from WANULCAS.XLS</i>	<i>dimensionless</i>	<i>Any integer value (100)</i>	<i>(Tree Management)</i>
410.	T_WoodHlInit[Tree]	Initial value of tree bare stem height (tree height excluded canopy)	m	0 - 15 (0)	Tree Parameters
411.	<i>T_WoodMoistFrac[Tree]</i>	<i>Standard moisture content for expressing marketable wood of each tree</i>	<i>dimensionless</i>	<i>0 - 1 (0)</i>	<i>(Tree Library)</i>

No	Acronym	Definition	Dimensions	Range of value (Default value)	Input Section (Link location in Excel)
412.	Temp_AType	A number governing type of soil temperature data used in the simulation(0= constant value of soil temperature , 1 =read from monthly average data,2=read from daily data which is read from external file)	dimensionless	1, 2 or 3 (1)	Soil Temperature
413.	Temp_Cons	Soil temperature throughout the simulation; corresponds to Temp_AType=0	°C	15 - 40 (28)	Soil Temperature
414.	Temp_DailyData	Actual daily data of soil temperature; corresponds to Temp_AType=2. Read from WaNuLCAS.XLS	°C	(see table in excel sheet weather)	(WEATHER)
415.	Temp_DailyPotEvap	Daily potential evaporation. Entered from WaNuLCAS.XLS	mm day ⁻¹	(see table in excel sheet weather)	(WEATHER)
416.	Temp_EvapPotConst	Amount of water evaporating from top soil in absence of plant cover	mm day ⁻¹	0 - 10 (3)	Soil Evaporation
417.	Temp_MonthAvg	Monthly average of soil temperature; corresponds toTemp_AType=1. Entered as graphical function	°C	(see Temp_Month Avg graph)	Soil Temperature
418.	Temp_PotEvapConst?	Parameter governing type of soil evaporation potential data. 1 = constant throughout simulation, 0 = daily data	dimensionless	0 or 1 (1)	Soil Evaporation
419.	TW_PotSuctAlphMax [Tree]	Plant potential where transpiration is (1-Alpha)*potential transpiration, where Alpha is a small value (e.g. 0.01)	cm	-7000 - -3 000 (-5000)	(Tree Library/ Water Uptake)
420.	TW_PotSuctAlphMin [Tree]	Plant potential where transpiration is Alpha*potential transpiration, where Alpha is a small value (e.g. 0.01)	cm	-30000 - -10000 (-15000)	(Tree Library/ Water Uptake)

No	Acronym	Definition	Dimensions	Range of value (Default value)	Input Section (Link location in Excel)
421.	W_FieldCapkCrit/[Zone]	Field capacity determined by a threshold rate of subsequent drainage (Kcrit) that is set in the pedotransfer worksheet; the actual field capacity used is the maximum of this value and the field capacity derived from the height above a groundwater table. Read and calculation from WaNuLCAS.XLS (pedotransfer). Input needed to run pedotranfer refer to the sheet pedotranfer	m ³ water m ⁻³ soil	(see table in excel sheet Soil Hydraulic)	(Soil Hydraulic)
422.	W_Hyd?	<i>Parameter governing water hydraulic lift application in model. 1 = apply hydraulic lift in overall water balance, 0 = otherwise</i>	<i>dimensionless</i>	0 - 1 (0)	<i>Soil Water and Nutrient</i>
423.	W_PhiPx/[Zone]	Graphs showing relationship between pressure head in <i>i</i> -th soil layer of each zone and matrix flux potential (the index x refers to the plants with the highest (H), lowest (L), medium-high (MH) or medium low (ML) rank of root water potential), but the graphs will be identical. Read and calculation from WaNuLCAS.XLS (pedotransfer). Input needed to run pedotranfer refer to the sheet pedotranfer	cm ² day ⁻¹	(see table in excel sheet Soil Hydraulic)	(Soil Hydraulic)
424.	W_PhiTheta/[Zone]	Matrix flux potential at a given theta/soil water content in layer <i>i</i> of each zone. Read and calculation from WaNuLCAS.XLS (pedotransfer). Input needed to run pedotranfer refer to the sheet pedotranfer	cm ² day ⁻¹	(see table in excel sheet Soil Hydraulic)	(Soil Hydraulic)
425.	W_PTheta/[Zone]	Graphs showing relationship between volumetric soil water content and pressure head in <i>i</i> -th soil layer of each zone. Read and calculation from WaNuLCAS.XLS (pedotransfer). Input needed to run pedotranfer refer to the sheet pedotranfer	cm	(see table in excel sheet Soil Hydraulic)	(Soil Hydraulic)

No	Acronym	Definition	Dimensions	Range of value (Default value)	Input Section (Link location in Excel)
426.	W_Thetalnacc[i][Zone]	Amount of volumetric soil water in <i>i</i> -th soil layer of each zone not available for plant. It is value of volumetric soil water at pF= 4.2 or P = -16000. Read and calculation from WaNuLCAS.XLS (pedotransfer). Input needed to run pedotranfer refer to the sheet pedotranfer	$l\ m^{-2}\ day^{-1}$	(see table in excel sheet Soil Hydraulic)	(Soil Hydraulic)
427.	W_Hyd?	<i>Parameter governing water hydraulic lift application in model. 1 = apply hydraulic lift in overall water balance, 0 = otherwise</i>	<i>dimensionless</i>	0 - 1 (0)	<i>Soil Water and Nutrient</i>
428.	W_Thetalnit[i][Zone]	Initial volumetric soil water content in <i>i</i> -th soil layer of each zone. Current values are 1, 0.9, 0.8, 0.7 for layer 1...4, respectively	$ml\ cm^{-3}$	0 - 1	Soil Water and N/ Initial Soil Water
429.	W_ThetaP[i][Zone]	Graphs showing relationship between pressure head in <i>i</i> -th soil layer of each zone and volumetric soil water content. Read and calculation from WaNuLCAS.XLS (pedotransfer). Input needed to run pedotranfer refer to the sheet pedotranfer	cm	0 - 0.5 (see table in excel sheet Soil Hydraulic)	(Soil Hydraulic)
430.	W_ThetaPMax[Zone]	Volumetric soil water content at a given maximum soil potential at top layer. Read and calculation from WaNuLCAS.XLS (pedotransfer). Input needed to run pedotranfer refer to the sheet pedotranfer	cm	(see table in excel sheet Soil Hydraulic)	(Soil Hydraulic)

Appendix 8.

Other Useful parameters and their definition (parameters which can be input or output which are not yet at users interface layer)

No	Acronym	Definition	Dimensions	Default value	Model Sector
1.	C_GroResMobFrac	Fraction of crop growth reserves that is remobilize into yield and root component	dimensionless	0.95	Crop Growth
2.	C_NDemand	Amount of Nitrogen or Phosphorus demanded by crop per day; for a crop biomass less than 2 Mg/ha demand is based on 5% N, above that (after canopy closure) on 1% N	kg ha ⁻¹	output	Crop Growth
3.	C_NUptTot	Total amount of Nitrogen or Phosphorus in all soil layers potentially available for crop uptake per day	g m ⁻²	output	Crop Growth
4.	C_Tmin	Minimum Air Temperature for Crop	⁰ Celsius	20	Crop Sequence
5.	C_TOpt	Optimum Air Temperature for Crop	⁰ Celsius	21	Crop Sequence
6.	CW_DemandAct	Actual amount of crop water demand per day. Potential demand reduced by plant water potential.	l m ⁻²	output	Crop Water

No	Acronym	Definition	Dimensions	Default value	Model Sector
7.	CW_UptTot	Total amount of water uptake by crop from all soil layers per day in each zone	$l\ m^{-2}$	output	Crop Water
8.	C_SeedConc[PlantComp]	Nutrient concentration on seed. Value for DW =1, N = 0.05 and P = 0.005	-	see definition	Crop Growth
9.	Evap_Surf	Amount of water evaporates from top soil per day in each zone	$l\ m^{-2}$	output	Soil Evaporation
10.	GHG_GWP_CH4	Global Warming Potential for CH4. Global Warming potential is the warming effect of a trace gas on the atmosphere. It differs between trace gases due to different atmospheric lifetime and different heat absorption capacity. It is expressed per molecule basis relative to CO ₂	-	15	GHG & Denitrification
11.	GHG_GWP_NO2	Global Warming Potential for NO ₂	-	310	GHG & Denitrification
12.	Mc_LitterC	Amount of carbon in dead plant biomass	$g\ m^{-2}$	output	Litter C
13.	Mn_LitterNlnpN [Zone,SiNut]	Amount of Nitrogen or Phosphorus in litter layer	$g\ m^{-2}$	output	Litter N
14.	N_ExchLittLay1 [Zone,SiNut]	Mineralisation Nitrogen or Phosphorus in litter layer	$g\ m^{-2}$	output	N Layer 1
15.	N_SomMin/ Exch [Zone,SiNut]	Mineralisation of Nitrogen or Phosphorus in soil layer <i>i</i>	$g\ m^{-2}$	output	N Layer 2-4
16.	Rt_CLrvt	Crop root growth as a function of time	$cm\ cm^{-3}\ day^{-1}$	output	Crop Root
17.	S&B_DailyDeadWoodLitT ransf	Rate of transfer of daily dead wood litter per day	$fraction\ day^{-1}$	0.005	Slash and Burn

No	Acronym	Definition	Dimensions	Default value	Model Sector
18.	S&B_DailyNecromLitTransf	Rate of transfer of necromass litter per day	fraction day ⁻¹	0.01	Slash and Burn
19.	S_BDEqPower	Power coefficient (b) of the allometric equation describing the decreasing of bulk density later effect on surface infiltration and saturated hydraulic conductivity	dimensionless	0.5	Soil Structure Dynamic
20.	T_BiomAllTrees	Total amount of aboveground biomass for all trees	kg m ⁻²	output	Tree Growth
21.	T_HarvPrunCum[Tree]	Total pruned tree biomass harvested	kg m ⁻²	output	Tree Growth
22.	T_LifallCum[Tree]	Cumulative amount of tree litterfall	kg m ⁻²	output	Tree Growth
23.	T_PrunCum	Cumulative amount of tree pruned biomass	kg m ⁻²	output	Tree Growth
24.	T_WatStressMem	A parameter influencing the effect of drought on litterfall.	-	0.75	Tree Water Parameter
25.	TF_AbRelSizePow[Tree]	Input parameter in oil palm module	-	2	Tree Fruit
26.	TF_AvgDWpFruit[Tree]	Average dry weight of oilpalm fruit	kg m ⁻²	-	Tree Fruit
27.	TF_FemSinkperBunch	Graphical input parameter in oil palm module as a function of fruit stage	-	-	Tree Fruit
28.	TF_FirstBudtoFlowerInit [Tree]	Number of phyllochron time units before sex determination during flower development	-	25	Tree Fruit
29.	TF_InitFruitpBranch [Tree]	Input parameter in OilPalm module	-	500	Tree Fruit

No	Acronym	Definition	Dimensions	Default value	Model Sector
30.	TF_MaleSinkperBunch	Graphical input parameter in oil palm module as a function of fruit stage	-	-	Tree Fruit
31.	TF_MaleThresh[Tree]	Input parameter in OilPalm module	-	0.17	Tree Fruit
32.	TF_MTrresptoWStress[Tree]	Input parameter in OilPalm module	-	0	Tree Fruit
33.	TF_Phyllocrontime[Tree]	Input parameter in oil palm module	-	15	Tree Fruit
34.	TF_PhysAgeInit[Tree]	Phyllochron age at time of planting or start of simulation. Input parameter in oil palm module	-	15	Tree Fruit
35.	TF_StageAbortSens	Graphical input parameter in oil palm module as a function of fruit stage	-	-	Tree Fruit
36.	TF_WatStressAbortFrac[Tree]	Input parameter in OilPalm module	-	0.1	Tree Fruit
37.	TW_Alpha	A small value determining plant maximum and minimum transpiration. Plant potential for maximum transpiration' (TW_PotSuctAlphMax, unit in cm) is defined as $(1 - TW_Alpha) * \text{potential transpiration}$ and plant potential for minimum transpiration' (TW_PotSuctAlphMin, unit in cm) is defined as $TW_Alpha * \text{potential transpiration}$.	-	0.1	Tree Water
38.	TW_AxResFactor	For a 10 m distance and a demand of 5 mm day ⁻¹ we expect the need for an additional gradient of 2.5 bar = 2500 cm; the factor is thus $5/250 = 0.02$	-	0.02	Tree Water

No	Acronym	Definition	Dimensions	Default value	Model Sector
39.	TW_L	Coefficient related to tree root conductivity	cm day ⁻¹	10 ⁻⁵	Tree Water
40.	TW_PotSuctBuff	Hydrostatic gradient to overcome transport resistance in wet soil I	cm	0.05	Tree water parameter
41.	W_PMax	Maximum value of soil potential in positive value	cm	0	Water layer 1

References

- Akyeampong E, Duguma B, Heineman AM, Kamara CS, Kiepe P, Kwesiga F, Ong CK, Otieno HJ and Rao MR (1995) A synthesis of ICRAF's research on alley cropping. In: Alley Farming Research and Development. AFINETA, Ibadan, Nigeria. pp 40-51.
- Arah J and Hodnett M (1997) Approximating soil hydrology in agroforestry models. *Agroforestry Forum* 8(2): 17-20.
- Bayala J, van Noordwijk M, Lusiana B, Ouédraogo S J, Teklehaimanot Z (2004) Separating the tree-soil-crop interactions in agroforestry parkland systems in Sapone (Burkina Faso) using WaNuLCAS. ICRAFSEA - INERA. Poster presented at 1st World Congress of Agroforestry, 27 June - 2 July 2004, Orlando - Florida, USA.
- Breman H and Kessler JJ (1997) The potential benefits of agroforestry in the Sahel and other semi arid regions. *European Journal of Agronomy* 7: 25-33.
- Burgess SSO, Adams MA, Turner NC and Ong CK (1998) Redistribution of soil water by tree root systems. *Oecologia* 3(115): 306-311.
- Cadisch G, Rowe E and van Noordwijk M (1997) Nutrient harvesting - the tree-root safety net. *Agroforestry Forum* 8(2): 31-33.
- Caldwell RM, Pachepsky YA and Timlin DJ (1996) Current research status on growth modeling in intercropping. In: O.Ito et al. (Eds) *Dynamics of Roots and Nitrogen in Cropping Systems of the Semi-Arid Tropics*. Japan International Research Center for Agricultural Sciences. pp 617-635.
- Cannell MGR, Mobbs DC and Lawson GJ (1998) Complementarity of light and water use in tropical agroforests. II. Modelled theoretical tree production and potential crop yield in arid to humid climates. *Forest Ecology and Management* 102: 275-282.
- Cannell MGR, van Noordwijk M and Ong CK (1996) The central agroforestry hypothesis: the trees must acquire resources that the crop would not otherwise acquire. *Agroforestry Systems* 33: 1-5.
- Dawson TE (1993) Hydraulic lift and water use by plants: implications for water balance, performance and plant plant interactions. *Oecologia* 95: 565-574.
- De Willigen P and Van Noordwijk M (1987) Roots for plant production and nutrient use efficiency. Doctoral thesis Agricultural University Wageningen 282 pp.
- De Willigen P and Van Noordwijk M (1989) Rooting depth, synchronization, synlocalization and N use efficiency under humid tropical conditions. In: Van de Heide, J. (eds) *Nutrient Management for Food Crop Production in Tropical Farming Systems*. Institute for Soil Fertility, Haren, pp. 145-156.

- De Willigen P and Van Noordwijk M (1991) Modeling nutrient uptake: from single roots to complete root systems. in: F.W.T. Penning de Vries, HH van Laar and MJ Kropff (eds) *Simulation and Systems Analysis for Rice Production (SARP)*. Simulation Monographs, PUDOC, Wageningen. p. 277-295.
- De Willigen P and Van Noordwijk M (1994) Diffusion and mass flow to a root with constant nutrient demand or behaving as a zero-sink. *Soil Sci.* 157: 162-175.
- De Willigen P, NE Nielsen, N Claassen and AM Castrignanò (2000) Modelling water and nutrient uptake. In: A.L. Smit, A.G. Bengough, C. Engels, M. Van Noordwijk, S. Pellerin and Van der Geijn (eds) 2000. *Root Methods, a Handbook*. Springer Verlag, Berlin. pp 509-544
- Gijsman AJ, Oberson A, Tiessen H and Friesen DK (1996) Limited applicability of the CENTURY model to highly weathered tropical soils. *Agron. J.* 88: 894-903.
- Gotelli ND and Graves GR (1996) *Null Models in Ecology*. Smithsonian Institution Press, Washington, 357 pp.
- Hairiah K, Purnomosidhi P, Khasanah N, Nasution N, Lusiana N, and van Noordwijk M (2003) Pemanfaatan Bagas dan Daduk Tebu untuk Perbaikan Status Bahan Organik Tanah dan Produksi Tebu di Lampung Utara: Pengukuran dan Estimasi Simulasi WaNuLCAS (Use of bagas and sugarcane trash to improve soil organic matter status and sugarcane yield in North Lampung: field measurement and simulation by WaNuLCAS model) . *Agrivita* Vol. 25 No. 1
- Hannon B and Ruth M (1994) *Dynamic Modeling*. Springer-Verlag, New York. 248 pp.
- Howard SB, Ong CK, Black CR and Khan AAH (1997) Using sap flow gauges to quantify water uptake by tree roots from beneath the crop rooting zone in agroforestry systems. *Agrofor. Syst.* 35: 15-29.
- Kropff MJ and Van Laar HH (1993) *Modeling crop - weed interactions*. CAB International, Wallingford (UK).
- Lott JE, Khan AAH, Ong CK and Black CK (1996) Sap flow measurements of lateral roots in agroforestry systems. *Tree Physiol* 16: 995-1001.
- Mobbs DC, Cannell MGR, Crout NMJ, Lawson GJ, Friend AD and Arah J (1998) Complementarity of light and water use in tropical agroforests. I. Theoretical model outline, performance and sensitivity. *Forest Ecology and Management* 102: 259-274.
- Muetzelfeldt R and Taylor J (1997) The suitability of AME (Agroforestry Modeling Environment) for agroforestry modeling. *Agroforestry Forum*, 8(2) 7-9.
- Muthuri C (2004) *Modelling leaf phenology effects on water use and growth; In Impact of agroforestry on crop performance and water resources in semi-arid central Kenya*. PhD thesis, Jomo Kenyatta University of Agriculture and Technology, Kenya, pp 222-251.

- Myers B, Van Noordwijk, M and Vityakon P (1997). Synchrony of nutrient release and plant demand: plant litter, soil environment and farmer management options. in: G. Cadisch and K.E. Giller (eds) *Driven by Nature: Plant Litter Quality and Decomposition*. CAB International, Wallingford (UK) pp. 215 - 229.
- Myers RJK, Palm CA, Cuevas E, Gunatilleke IUN and Brossard M (1994) The synchronisation of nutrient mineralisation and plant nutrient demand. in: P.L. Woomer and M.J. DSwift (Eds.) *The Biological Management of Tropical Soil Fertility*. John Wiley, Chichester (UK) pp 81-116.
- Ong CK 1995. The 'dark side' of intercropping: manipulation of soil resources. In: Sinoquet H and Cruz P (eds.) *Ecophysiology of Tropical Intercropping*, 482 pp. *Institute National de la Recherche Agronomique, Paris (France)*.
- Ong CK and PA Huxley (Eds.). (1996) *Tree-Crop Interactions - a Physiological Approach*. CAB International, Wallingford (UK).
- Palm, C.A., Alegre, J.C., Arevalo, L., Mutuo, P.K., Mosier, A.R. and Coe, R. (2002) Nitrous oxide and methane fluxes in six different land use systems in the Peruvian Amazon. *Global Biogeochemical Cycles* 16(4), 1073.
- Parton WJ, Ojima DS, Cole CV and Schimel DS (1994) A general model for soil organic matter dynamics: sensitivity to litter chemistry, texture and management. In: *Quantitative Modeling of Soil Forming Processes*. Special Publication 39, Soil Science Society of America, Madison WI, USA, pp 147-167.
- Radersma S and C Ong (2004) Spatial distribution of root length density and soil water of linear agroforestry systems in sub-humid Kenya: implications for agroforestry models. *Forest Ecology and Management*, 188(1-3), 77-89
- Rao MR, Nair PK and Ong CK (1997) Biophysical interactions in tropical agroforestry systems. *Agroforestry Systems* 38: 3 - 49.
- Rowe EC, Hairiah K, Giller KE, Van Noordwijk M and Cadisch G (1999) Testing the safety-net role of hedgerow tree roots by 15N placement at depths.. *Agroforestry Systems* 43: 81-93.
- Rykiel EJ (1996) Testing ecological models: the meaning of validation. *Ecological Modeling* 90: 229-244.
- Sanchez P (1995) Science in agroforestry. *Agroforestry Systems* 30: 5-55.
- Shepherd KD and Soule MJ (1998) Soil fertility management in West Kenya: dynamic simulation of productivity, profitability and sustainability at different resource endowment levels. *Agriculture, Ecosystems & Environment* (in press).
- Sinoquet H, Adam B, Rivet P and Godin C (1997) Interactions between light and plant architecture in an agroforestry walnut tree. *Agroforestry Forum*, 8(2) 37-39.
- Smith DM, Jackson NA, Roberts JM and Ong CK (1998) Reverse flow in tree roots and downward siphoning of water by *Grevillea robusta*. *Functional Ecology* 2(13): 256-264.

- Suprayogo D, Widiyanto, Cadish G, and van Noordwijk M (2003) A Pedotransfer resource database (PTFRDB) for tropical soils : test with the water balance of WaNuLCAS in: D Post (eds) Proceedings of the 2003 MODSIM Conference - Volume 1. Townsville, Australia. p 584-589.
- Suprayogo D, Widiyanto and Lusiana B (2002) Diagnosis Kesehatan Bertani Berbasis Pohon: Apakah air dan hara tanah digunakan secara efisien. In: S.M. Sitompul and S.R. Utami (eds) Akar Pertanian Sehat: Konsep dan Pemikiran. Biological Management of Soil Fertility (BMSF), Brawijaya University, Malang (Indonesia). p 117-129
- Suprayogo, D. (2000) Testing the Safety - Net Hypothesis in Hedgerow Intercropping: water balance and mineral - N leaching in the humid tropics. PhD thesis, Imperial College London, Wye Campus, UK, 316 pp.
- Tomich TP, Van Noordwijk M, Budidarseno S, Gillison A, Kusumanto T, Murdiyarso D, Stolle F and Fagi AM (1998b) Alternatives to Slash-and-Burn in Indonesia, Summary report and synthesis of Phase II. ICRAF S.E. Asia, Bogor, Indonesia, 139 pp.
- Tomich TP, Van Noordwijk M, Vosti S and Whitcover J (1998a) Agricultural Development with Rainforest Conservation: Methods for Seeking Best Bet Alternatives to Slash-and-Burn, with Applications to Brazil and Indonesia. *Agricultural Economics* 19: 159-174.
- Van Noordwijk M, Rahayu S, Williams SE, Hairiah K, Khasanah N, Schroth G (2003) Crop and tree root-system dynamics In M. van Noordwijk, G. Cadisch, C.K. Ong (eds) *BelowGround Interaction in tropical Agroecosystems: Concepts and Models with multiple plant component*, CABI, Wallingford, UK
- Van Noordwijk M (1989) Rooting depth in cropping systems in the humid tropics in relation to nutrient use efficiency. In: J. van der Heide (ed.) *Nutrient Management for Food Crop Production in Tropical Farming Systems*. Institute for Soil Fertility, Haren. p 129-144.
- Van Noordwijk M (1996a) A simple model to quantify mulch and shade effects. In: C.K. Ong and P.A. Huxley (Eds.). *Tree-Crop Interactions - a Physiological Approach*. CAB International, Wallingford (UK). pp 51-72.
- Van Noordwijk M (1996b) Models as part of agroforestry research design. *AGRIVITA* 19: 192-197.
- Van Noordwijk M and Brouwer G (1997). Roots as sinks and sources of carbon and nutrients in agricultural systems. in: L. Brussaard and R. Ferrera-Cerrato (eds.) *Soil Ecology in Sustainable Agricultural Systems*. CRC Lewis Publ., Boca Raton. pp 71-89.
- Van Noordwijk M and Cadisch G (2002) Access and excess problems in plant nutrition. *Plant and Soil* 247:25-40

- Van Noordwijk M and Lusiana B (1999) WaNuLCAS, a model of water, nutrient and light capture in agroforestry systems. *Agroforestry Systems* 43: 217-242.
- Van Noordwijk M and Ong CK (1999) Can the ecosystem mimic hypotheses be applied to farms in African savannahs?. *Agroforestry Systems* 45: 131-158.
- Van Noordwijk M and Purnomosidhi P (1995) Root architecture in relation to tree soil crop interactions and shoot pruning in agroforestry. *Agroforestry Systems* 30: 161-173.
- Van Noordwijk M and Van de Geijn SC (1996) Root, shoot and soil parameters required for process-oriented models of crop growth limited by water or nutrients. *Plant and Soil* 183: 1-25.
- Van Noordwijk M, Hairiah K, Lusiana B and Cadisch G (1998a) Tree - Soil - Crop Interactions in Sequential and Simultaneous Agroforestry Systems. in: L. Bergstrom and H. Kirschner (Ed.) *Carbon and Nutrient Dynamics in Natural and Agricultural Tropical Ecosystems*. CAB International, Wallingford (UK). pp 173-190.
- Van Noordwijk M, Lawson G, Groot JJR, Hairiah K, (1996) Root distribution in relation to nutrients and competition. In: C.K. Ong and P.A. Huxley (Eds.). *Tree-Crop Interactions - a Physiological Approach*. CAB International, Wallingford (UK). pp 319-364.
- Van Noordwijk M, Radersma S and Lusiana B (1999) Modelling root architecture and phosphorus uptake in agroforestry. *Agroforestry Forum* 9(4) 28-30.
- Van Noordwijk M, Van Roode M, McCallie EL and Lusiana B (1998b) Erosion and sedimentation as multiscale, fractal processes: implications for models, experiments and the real world. In: F. Penning de Vries, F. Agus and J. Kerr (Eds.) *Managing Soil Erosion*. CAB International, Wallingford. 223-253.
- Vandermeer JH (1989) *The Ecology of Intercropping*. Cambridge University Press, Cambridge.
- Verchot, L.V., Davidson, E.A., Cattânio, J.H. and Ackerman, I.L. (2000) Land-use change and biogeochemical controls of methane fluxes in soils of eastern Amazonia. *Ecosystems* 3, 41-56.
- Verchot, L.V., Davidson, E.A., Cattânio, J.H., Ackerman, I.L., Erickson, H.E. and Keller, M. (1999) Land use change and biogeochemical controls of nitrogen oxide emissions from soils in eastern Amazonia. *Global Biogeochemical Cycles* 13, 31-46.
- Verchot, L.V., Mosier, A., Baggs, E.M. and Palm, C.A., (2004) Soil-Atmosphere Gas Exchange in Tropical Agriculture: Contributions to Climate Change. In: M. Van Noordwijk, G. Cadisch and C.K. Ong (Eds.) *Belowground Interactions in Tropical Agroecosystems*, CAB International, Wallingford (UK), in press
- Akyeampong E, Duguma B, Heineman AM, Kamara CS, Kiepe P, Kwesiga F, Ong CK, Otieno HJ and Rao MR (1995) A synthesis of ICRAF's research on alley cropping. In: *Alley Farming Research and Development*. AFNETA, Ibadan, Nigeria. pp 40-51.

- Wösten JHM, A Lilly, A Nemes and C Le Bas (1998) Using existing soil data to derive hydraulic parameters for simulation models in environmental studies and in land use planning. Report 156, SC-DLO, Wageningen (the Netherlands), 106 pp.
- Wösten JMH, Finke PA and Jansen MJW (1995) Comparison of class and continuous pedotransfer functions to generate soil hydraulic characteristics. *Geoderma* 66: 27-37.
- Young A (1997) *Agroforestry for Soil Management*. 2nd ed. CAB International, Wallingford (UK). 320 pp.
- Young A, Menz K, Muraya P and Smith C (1990) SCUAF Soil changes under agroforestry. Computer program with user's handbook. Version 2. ICRAF, Nairobi (Kenya) 124 pp.
- Young A, Menz K, Muraya P and Smith C, (1998) SCUAF Version 4: A model to estimate soil changes under agriculture, agroforestry and forestry. ACIAR Technical Reports Series No. 41, ACIAR, Canberra (Australia). 49 pp.

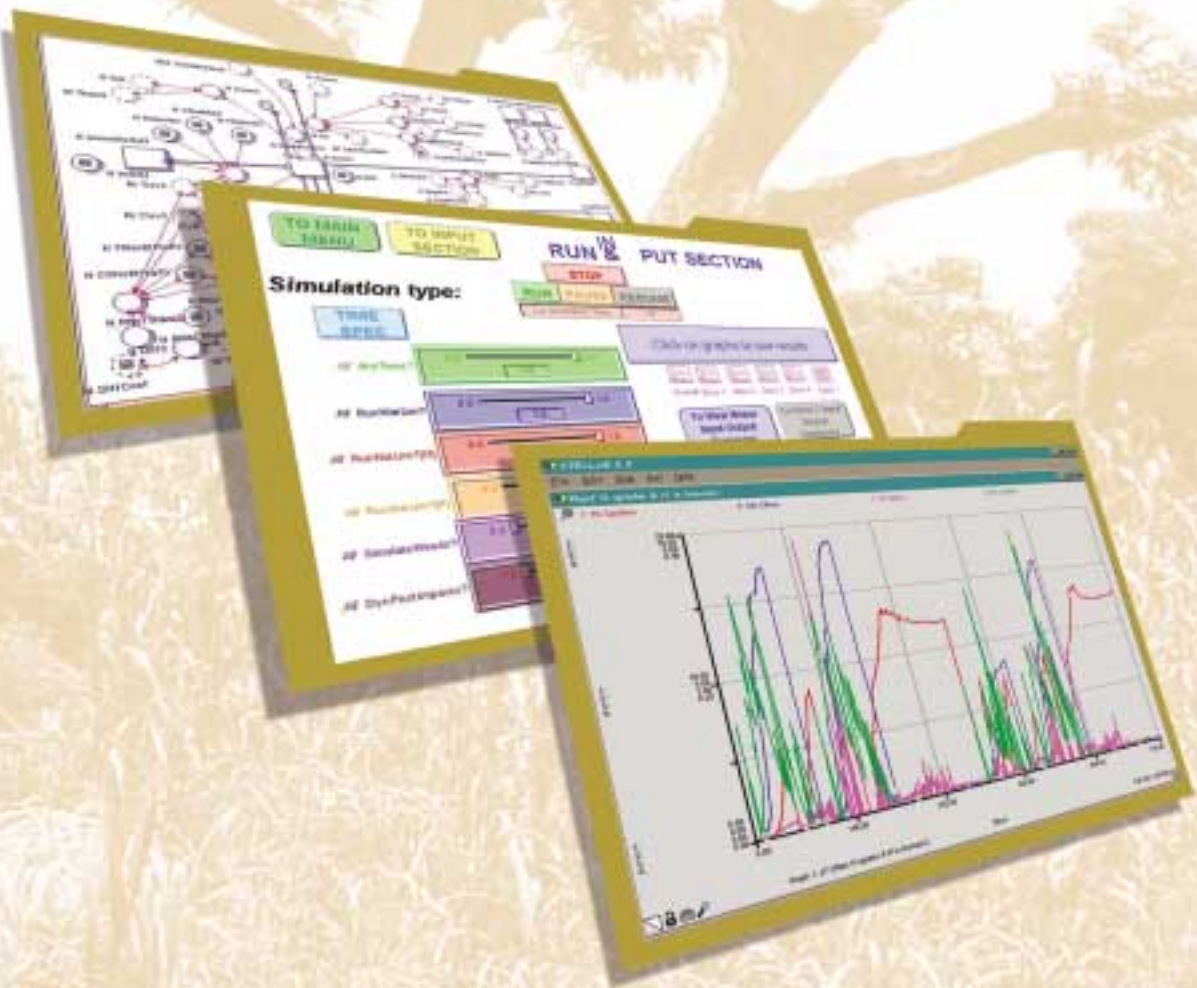

World Agroforestry Centre
TRANSFORMING LIVES AND LANDSCAPES

DFID Department For
International
Development